

AXIS A8207-VE Network Video Door Station

User Manual

AXIS A8207-VE Network Video Door Station

Table of Contents

Solution overview	3
Product overview	4
Installation	6
Get started	7
Find the device on the network	7
Access the device	7
Secure passwords	7
Additional settings	9
Change the root password	9
Set up direct SIP (P2P)	9
Set up SIP through a server (PBX)	10
Create an organization	10
Create a contact	10
Configure the call button	11
Set up as card reader - network connection	12
Set up as card reader - wired connection	12
Use DTMF to unlock the door for a visitor	13
Transmit live video to a monitor	14
Print a contact list	14
Learn more	15
The contact list	15
Voice over IP (VoIP)	15
Set up rules for events	17
Applications	17
Daily use	18
Use the keypad	18
Troubleshooting	19
Reset to factory default settings	19
Check the current firmware	19
Upgrade the firmware	19
Technical issues, clues and solutions	20
Performance considerations	20
Specifications	22
Front panel indicators and controls	22
LED indicators	22
SD card slot	22
Buttons	23
Connectors	23
Safety information	26
Hazard levels	26
Other message levels	26

AXIS A8207-VE Network Video Door Station

Solution overview

Solution overview

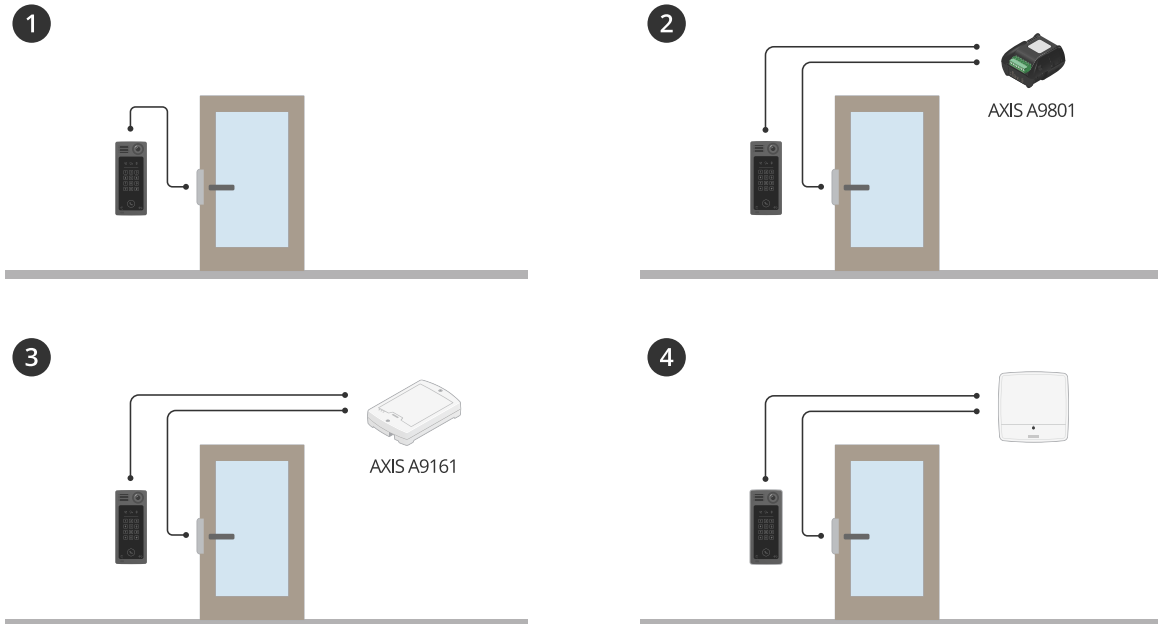

- 1 Door station
- 2 Door station combined with AXIS A9801
- 3 Door station combined with AXIS A9161
- 4 Door station combined with an access control system, for example AXIS A1001 or AXIS A1601

AXIS A8207-VE Network Video Door Station

Product overview

Product overview

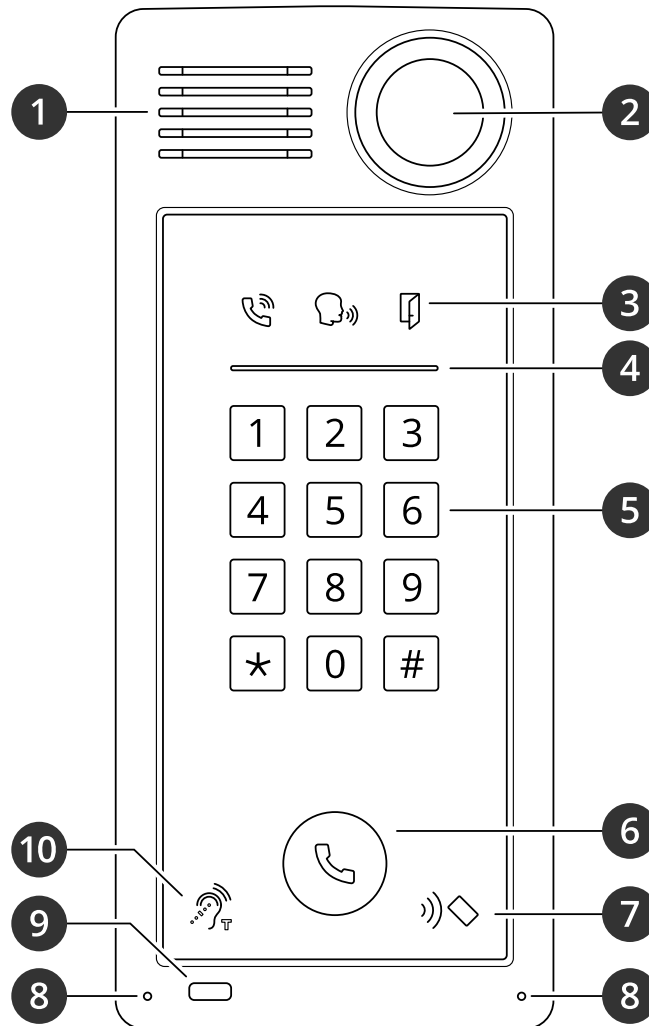

- 1 Speaker
- 2 Camera
- 3 Call indicator icons on page 22
- 4 Card reader indicator stripe on page 22
- 5 Keypad
- 6 Call button on page 22
- 7 Card reader icon
- 8 Microphone
- 9 PIR-sensor
- 10 T-coil icon

AXIS A8207-VE Network Video Door Station

Product overview

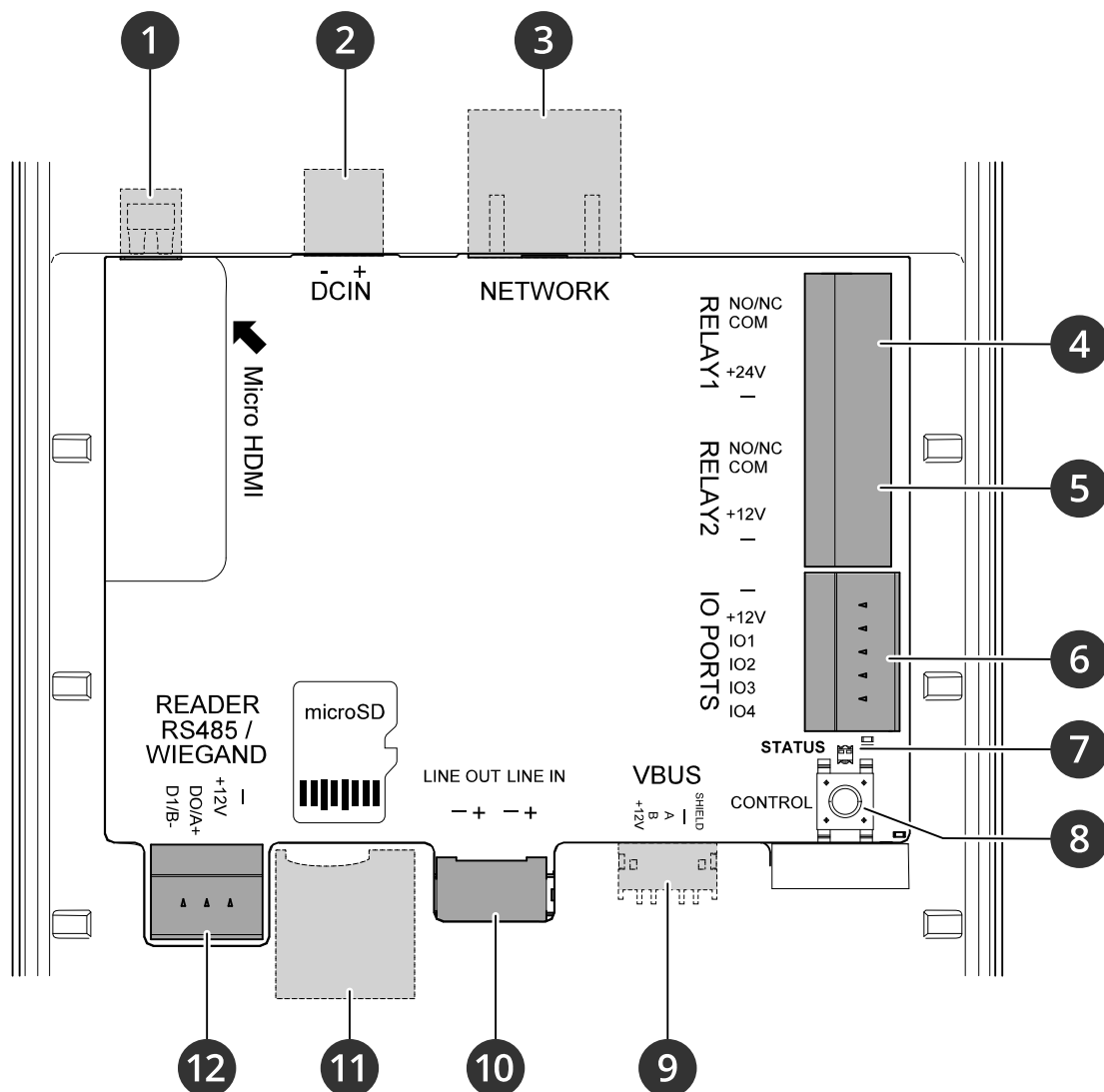

- 1 HDMI connector on page 23 (microHDMI)
- 2 Power connector on page 25
- 3 Network connector on page 23 (PoE+)
- 4 Relay connector on page 23
- 5 Relay connector on page 23
- 6 I/O connector on page 24
- 7 Status LED
- 8 Control button on page 23
- 9 2N VBUS (not used)
- 10 Audio connector on page 23
- 11 SD card slot on page 22 (microSD/microSDHC/microSDXC)
- 12 Reader connector on page 24

AXIS A8207-VE Network Video Door Station

Installation

Installation



To watch this video, go to the web version of this document.

www.axis.com/products/online-manual/44899#t10170588

Installation video for A8207-VE reader.



To watch this video, go to the web version of this document.

www.axis.com/products/online-manual/44899#t10170587

Installation video for A8207-VE relay.

AXIS A8207-VE Network Video Door Station

Get started

Get started

Find the device on the network

To find Axis devices on the network and assign them IP addresses in Windows®, use AXIS IP Utility or AXIS Device Manager. Both applications are free and can be downloaded from axis.com/support.

For more information about how to find and assign IP addresses, go to *How to assign an IP address and access your device*.

Access the device

1. Open a browser and enter the IP address or host name of the Axis device.
If you do not know the IP address, use AXIS IP Utility or AXIS Device Manager to find the device on the network.
2. Enter the username and password. If you access the device for the first time, you must set the root password. See *Set a new password for the root account on page 7*.

Secure passwords

Important

Axis devices send the initially set password in clear text over the network. To protect your device after the first login, set up a secure and encrypted HTTPS connection and then change the password.

The device password is the primary protection for your data and services. Axis devices do not impose a password policy as they may be used in various types of installations.

To protect your data we strongly recommend that you:

- Use a password with at least 8 characters, preferably created by a password generator.
- Don't expose the password.
- Change the password at a recurring interval, at least once a year.

Set a new password for the root account

Important

The default administrator username is **root**. If the password for root is lost, reset the device to factory default settings. See *Reset to factory default settings on page 19*



To watch this video, go to the web version of this document.

www.axis.com/products/online-manual/44899#t10098905

Support tip: Password security confirmation check

1. Type a password. Follow the instructions about secure passwords. See *Secure passwords on page 7*.

AXIS A8207-VE Network Video Door Station

Get started

2. Retype the password to confirm the spelling.
3. Click **Save**. The password has now been configured.

AXIS A8207-VE Network Video Door Station

Additional settings

Additional settings

This section will cover all the important configurations that an installer needs to do to get the product up and running after the hardware installation has been completed.

Change the root password

1. Log in to the product's webpage and go to **System > Users**.
2. For the root user, click **Edit**.
3. Enter a new password and save.

Set up direct SIP (P2P)

VoIP (Voice over IP) is a group of technologies that enables voice and multimedia communication over IP networks. For more, see *Voice over IP (VoIP)* on page 15.

In this product VoIP is enabled through the SIP protocol. For more information about SIP, see *Session Initiation Protocol (SIP)* on page 16

There are two types of setups for SIP. Peer-to-peer is one of them. Use peer-to-peer when the communication is between a few user agents within the same IP network and there is no need for extra features that a PBX-server could provide. For information on how to set it up, see *Peer-to-peer SIP (P2PSIP)* on page 16.

1. Go to **VoIP > SIP settings** and select **Enable SIP**.
2. In **Call timeout**, set the number of seconds that a call will last before it ends if there is no answer.
3. To allow the device to receive incoming calls, select **Allow incoming calls**.

NOTICE

When you allow incoming calls, the device accepts calls from any device connected to the network. If the device is accessible from a public network or the internet, we recommend you to disable incoming calls.

4. Set the number of seconds before timeout for incoming calls.
5. Click **Save**.
6. In **Port settings**, enter the **SIP port number** and **SIP TLS port number**.

Note

- **SIP port** – for SIP sessions. Signalling traffic through this port is non-encrypted. The default port number is 5060.
 - **SIP TLS port** – for SIPS and TLS secured SIP sessions. Signalling traffic through this port is encrypted with Transport Layer Security (TLS). The default port number is 5061.
 - **RTP start port** – Enter the port used for the first RTP media stream in a SIP call. The default start port for media transport is 4000. Some firewalls might block RTP traffic on certain port numbers. A port number must be between 1024 and 65535.
7. Click **Save**.
 8. In **NAT traversal**, select the protocols you want to enable for NAT traversal.

Note

Use NAT traversal when the device is connected to the network from behind a NAT router or a firewall. For more information see .

AXIS A8207-VE Network Video Door Station

Additional settings

Set up SIP through a server (PBX)

VoIP (Voice over IP) is a group of technologies that enables voice and multimedia communication over IP networks. For more, see *Voice over IP (VoIP)* on page 15.

In this product VoIP is enabled through the SIP protocol. For more information about SIP, see *Session Initiation Protocol (SIP)* on page 16

There are two types of setups for SIP. A PBX-server is one of them. Use a PBX-server when the communication should be between an infinite number of user agents within and outside the IP network. Additional features could be added to the setup depending on the PBX-provider. For more information see, *Private Branch Exchange (PBX)* on page 16.

1. Request the following information from your PBX provider:
 - User ID
 - Domain
 - Password
 - Authentication ID
 - Caller ID
 - Registrar
 - RTP start port
2. Go to **VoIP > SIP accounts > Create account**.
3. Enter a **Name** for the account.
4. Select **Registrar**.
5. Select a transport mode.
6. Add the account information from the PBX provider.
7. Click **Save**.
8. Set up the SIP settings the same way as for peer-to-peer. See *Set up direct SIP (P2P)* on page 9 for more information.

Create an organization

Note

Every contact in the contact list must belong to an organization.

1. Go to **VoIP > Contact list > Contacts**.
2. Click **New**.
3. Enter a name and description of the organization.
4. Click **Save**.

Create a contact

This example explains how to create a new contact in the contact list. This contact:

- has a SIP address
- belongs to an organization

AXIS A8207-VE Network Video Door Station

Additional settings

- belongs to a department

Before you start

- Create the organization in the contact list. To find out how to create it, see *Create an organization on page 10*.
 - Enable SIP in **VoIP > SIP settings**.
1. Go to **VoIP > Contact list > Contacts**.
 2. Click **Edit** next to the name of the organization to which the contact belongs.
 3. Click **New**.
 4. Enter the first and last name of the contact.
 5. Enter an available speed dial number.

Note

The speed dial number is used to call the contact from the door station. If you enter a speed dial number which is already assigned to another contact, a warning message appears and you cannot save the contact.

6. Under **Department**, select **New** and enter the name of the department.
7. In **Call information**, select **SIP address**.
8. Enter the contact's SIP address.

Note

For information about SIP addresses, see *Session Initiation Protocol (SIP) on page 16*.

9. Select the SIP account to call from.
10. In **Fallback**, select **None**.

Note

A fallback is a contact, to whom the call is forwarded if the original contact does not reply.

11. Click **Save**.

Configure the call button

By default, the call button is configured to make VMS (Video Management System) calls. If you want to keep this configuration, you just need to add the Axis network door station to the VMS.

This example explains how to set up the system to call a contact in the contact list when a visitor presses the call button.

1. Go to **VoIP > Contact list > Call button** and click **Add**.
2. Select a contact and click **Add**.
3. Deselect **VMS call**.
4. Click **Save**.

To disable the call button:

1. Don't add any recipients, or remove already added recipients.
2. Deselect **VMS call**.
3. Click **Save**.

AXIS A8207-VE Network Video Door Station

Additional settings

Set up as card reader – network connection

To use the door station as a card reader, you must connect it to a door controller. The door controller stores all credentials and keeps track of who is allowed through the door. In this example we connect the devices over the network. We also modify the allowed card types.

Important

The network connection only works with Axis door controllers. To connect to a non-Axis door controller, you need to physically connect the devices with wires. See *Set up as card reader – wired connection on page 12*.

Before you start

Configure the door controller's hardware, using the Wiegand protocol for the reader. See the door controller's user manual for instructions.

Set up the door station as a card reader

1. Go to **Hardware > Reader > Reader protocol > Protocol** and select **VAPIX reader**.
2. Click **Connect to Axis door controller**.
3. In the pop-up, select the protocol for communicating with the door controller.
4. Enter the IP address and credentials for the door controller.
5. Click **Save**.
6. In **Selected reader**, select the reader.
7. Click **Save**.
8. In the **Card types** tab, select the card types to allow.

Note

You can keep the default set of card types or modify the list according to your needs.

9. Click **Save**.

Set up as card reader – wired connection

To use the door station as a card reader, you must connect it to a door controller. The door controller stores all credentials and keeps track of who is allowed through the door. In this example, we connect the devices with wires, we use the Wiegand protocol, activate the beeper and use one I/O port for the LED. We also modify the allowed card types.

Important

Use I/O ports that are not already in use. If you use I/O ports already in use, any events created for these ports will stop working.

Before you start

- Physically connect the door station to a door controller. Use the electrical wiring drawings available at axis.com/products/axis-a8207-ve
- Configure the door controller's hardware, using the Wiegand protocol for the reader. See the door controller's user manual for instructions.

Set up the door station as a card reader

1. Go to **Hardware > Reader > Reader protocol > Protocol** and select **Wiegand**.
2. In **Beeper**, select **Activate beeper**.

AXIS A8207-VE Network Video Door Station

Additional settings

3. Under **Input for beeper**, select I3.
4. In **Inputs used for LED control**, select 1.
5. Under **Input for LED1**, select I1.
6. Select what colors to use for each state.
7. Click **Save**.
8. In the **Card types** tab, select the card types to allow.

Note

You can keep the default set of card types or modify the list according to your needs.

9. Click **Save**.

Use DTMF to unlock the door for a visitor

When a visitor makes a call from the door station, the person who answers can use the Dual-Tone Multi-Frequency signaling (DTMF) of his SIP device to unlock the door. The door controller unlocks and locks the door.

This example explains how to:

- define the DTMF signal in the door station
- set up the door station to:
 - request the door controller to unlock the door, or
 - unlock the door using the internal relay.

You make all settings in the door station's webpage.

Before you start

- Allow SIP calls from the device and set up a SIP account. See *Set up direct SIP (P2P)* and *Set up SIP through a server (PBX)*.

Define the DTMF signal in the door station

1. Go to **VoIP > DTMF**.
2. Click the pencil next to the SIP account.
3. Click **Add**.
4. In the **Name** field, enter "Unlock door".
5. In the **Sequence** field, enter "1".
6. Click **Apply** and then **OK**.

Set up the door station to request the door controller to unlock the door

1. Go to **Events > Management > Action rules** and click **Add**.
2. In the **Name** field, enter "DTMF unlock door".
3. From the list of triggers, select **Call, DTMF** and **Unlock door**.
4. From the list of actions, select **Axis Door Control**.
5. Click **New Recipient**.

AXIS A8207-VE Network Video Door Station

Additional settings

6. Enter the details for the door controller and click **OK**.
7. Click **Retrieve doors** and select the door from the list.
8. Under **Door actions**, select **AccessDoor**.
9. Click **OK**.

Set up the door station to unlock the door using the internal relay

1. Follow the steps under **Define the DTMF signal in the door station**
2. Go to **Events > Management > Action rules** and click **Add**.
3. In the **Name** field, enter "DTMF unlock door".
4. From the list of triggers, select **Call, DTMF and Unlock door**.
5. From the list of actions, select **Output Port**.
6. From the list of ports, select **Relay 1 (Port 4)**.
7. Select **Duration**.
8. Select **Go to opposite state after** and set it to 7 seconds, which means that the door is open for 7 seconds.
9. Click **OK**.

Transmit live video to a monitor

Your device can transmit a live video stream to an HDMI monitor without a network connection. Use the monitor to see who is at the door.

1. Connect an external monitor to the HDMI connector.
2. Adjust the HDMI settings in **System > HDMI**.

Print a contact list

You can print a list of all or some of the contacts in the contact list with their speed dial numbers. To print a list of all contacts:

1. Go to **VoIP > Contact list > Contacts** and click **Print contact list**.
2. Enter a message, that will be the title of the list.
3. Enter the name of the building or organization and the address.
4. Select to print all contacts.
5. Click **Print**.

AXIS A8207-VE Network Video Door Station

Learn more

Learn more

The contact list

The contact list consists of:

- Organizations – companies or organizations located in the building where the door station is placed.
- Contacts – persons belonging to an organization and sometimes also a department. You assign a speed dial number to each contact. For each contact you can assign a fallback, to whom the call is forwarded if the original contact does not answer.
- Departments – a contact can belong to a department. You create a department when you create a contact.
- Call groups – consists of several contacts or SIP addresses. You call all recipients in a call group simultaneously, and any recipient can answer the call.

You can print a list of all the contacts in the contact list to place next to the door station.

In the contact list you can also configure the call button, to decide where the call will go when a visitor presses it.

Voice over IP (VoIP)

Voice over IP (VoIP) is a group of technologies that enables voice communication and multimedia sessions over IP networks, such as the internet. In traditional phone calls, analog signals are sent through circuit transmissions over the Public Switched Telephone Network (PSTN). In a VoIP call, analog signals are turned into digital signals to make it possible to send them in data packets across local IP networks or the internet.

In the Axis product, VoIP is enabled through the Session Initiation Protocol (SIP) and Dual-Tone Multi-Frequency (DTMF) signaling.

Example

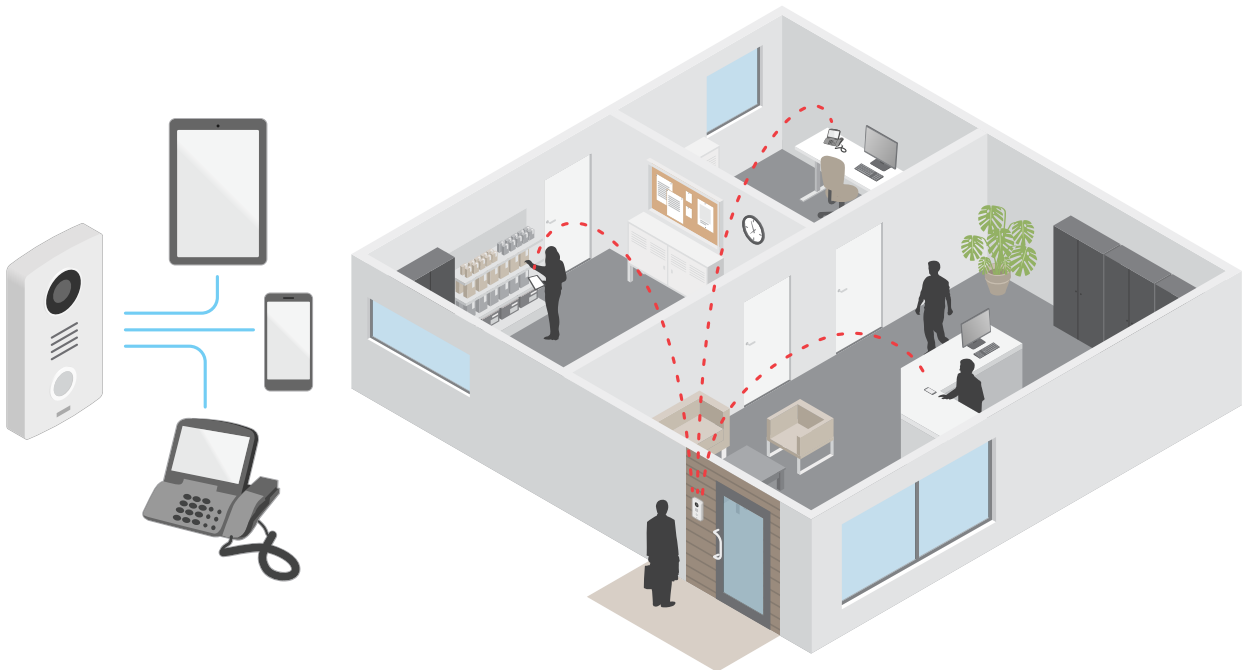

When you press the call button on an Axis door station, a call is initiated to one or more predefined recipients. When a recipient replies, a call is established. The voice and video is transferred through VoIP technologies.

AXIS A8207-VE Network Video Door Station

Learn more

Session Initiation Protocol (SIP)

The Session Initiation Protocol (SIP) is used to set up, maintain and terminate VoIP calls. You can make calls between two or more parties, called SIP user agents. To make a SIP call you can use, for example, SIP phones, softphones or SIP-enabled Axis devices.

The actual audio or video is exchanged between the SIP user agents with a transport protocol, for example RTP (Real-Time Transport Protocol).

You can make calls on local networks using a peer-to-peer setup, or across networks using a PBX.

Peer-to-peer SIP (P2PSIP)

The most basic type of SIP communication takes place directly between two or more SIP user agents. This is called peer-to-peer SIP (P2PSIP). If it takes place on a local network, all that's needed are the SIP addresses of the user agents. A typical SIP address in this case would be `sip:<local-ip>`

Example

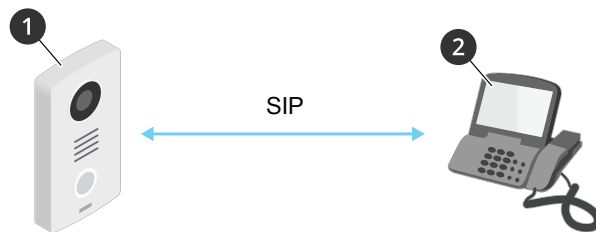

- 1 User agent A - door station. SIP address: `sip:192.168.1.101`
- 2 User agent B - SIP-enabled phone. SIP address: `sip:192.168.1.100`

You can set up the Axis door station to call for example a SIP-enabled phone on the same network using a peer-to-peer SIP setup.

Private Branch Exchange (PBX)

When you make SIP calls outside your local IP network, a Private Branch Exchange (PBX) can act as a central hub. The main component of a PBX is a SIP server, which is also referred to as a SIP proxy or a registrar. A PBX works like a traditional switchboard, showing the client's current status and allowing for example call transfers, voicemail, and redirections.

The PBX SIP server can be set up as a local entity or offsite. It can be hosted on an intranet or by a third party provider. When you make SIP calls between networks, calls are routed through a set of PBXs, that query the location of the SIP address to be reached.

Each SIP user agent registers with the PBX, and can then reach the others by dialing the correct extension. A typical SIP address in this case would be `sip:<user>@<domain>` or `sip:<user>@<registrar-ip>`. The SIP address is independent of its IP address and the PBX makes the device accessible as long as it is registered to the PBX.

Example

AXIS A8207-VE Network Video Door Station

Learn more

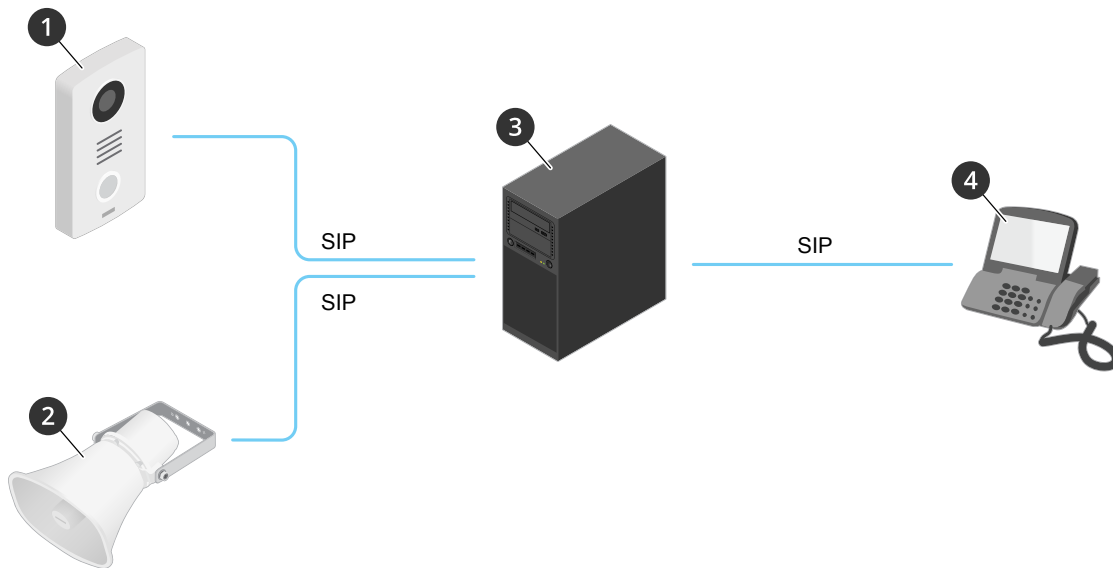

- 1 *sip.mydoor@company.com*
- 2 *sip.myspeaker@company.com*
- 3 **PBX** *sip.company.com*
- 4 *sip.office@company.com*

When you press the call button on an Axis door station, the call is forwarded through one or more PBXs to a SIP address either on the local IP network or over the internet.

Set up rules for events

You can create rules to make your device perform an action when certain events occur. A rule consists of conditions and actions. The conditions can be used to trigger the actions. For example, the device can start a recording or send an email when it detects motion, or show an overlay text while the device is recording.

To learn more, check out our guide *Get started with rules for events*.

Applications

AXIS Camera Application Platform (ACAP) is an open platform that enables third parties to develop analytics and other applications for Axis products. To find out more about available applications, downloads, trials and licenses, go to axis.com/applications.



To find the user manuals for Axis applications, go to axis.com.

AXIS A8207-VE Network Video Door Station

Daily use

Daily use

Use the keypad

I want to...	Action
Call someone who can let me into the building.	Press  .
Call a person in the building.	Enter the person's speed dial number and press  .
Open the door with my card and PIN.	Tap the card and enter the PIN.
Open the door with my PIN.	Enter the PIN and press #.
Open the door with my card.	Tap the card.

AXIS A8207-VE Network Video Door Station

Troubleshooting

Troubleshooting

Reset to factory default settings

Important

Reset to factory default should be used with caution. A reset to factory default resets all settings, including the IP address, to the factory default values.

To reset the product to the factory default settings:

1. Disconnect power from the product.
2. Press and hold the control button while reconnecting power. See *Product overview on page 4*.
3. Keep the control button pressed for 15–30 seconds until the status LED indicator flashes amber.
4. Release the control button. The process is complete when the status LED indicator turns green. The product has been reset to the factory default settings. If no DHCP server is available on the network, the default IP address is 192.168.0.90
5. Use the installation and management software tools to assign an IP address, set the password, and access the product.

The installation and management software tools are available from the support pages on axis.com/support

It is also possible to reset parameters to factory default through the web interface. Go to **Maintenance > Maintenance actions** and click **Restore** to reset to factory default values but keep the IP address, or **Default** to reset all values including the IP address.

Check the current firmware

Firmware is the software that determines the functionality of network devices. One of your first actions when you troubleshoot a problem should be to check the current firmware version. The latest version may contain a correction that fixes your particular problem.

To check the current firmware:

1. In the device's webpage, go to **Overview**.
2. Check the **Firmware version**.

Upgrade the firmware

Important

Preconfigured and customized settings are saved when the firmware is upgraded (provided that the features are available in the new firmware), although this is not guaranteed by Axis Communications AB.

Important

Make sure the device remains connected to the power source throughout the upgrade process.

Note

When you upgrade the device with the latest firmware, the device receives the latest functionality available. Always read the upgrade instructions and release notes available with each new release before you upgrade the firmware. To find the latest firmware and the release notes, go to axis.com/support/firmware

1. Download the latest firmware file to your computer, available free of charge at axis.com/support/firmware
2. Log in to the device as an administrator.

AXIS A8207-VE Network Video Door Station

Troubleshooting

3. Go to **System > Maintenance > Firmware upgrade** and follow the instructions on the page. When the upgrade has finished, the device restarts automatically.

Technical issues, clues and solutions

If you can't find what you're looking for here, try the troubleshooting section at axis.com/support.

Problems upgrading the firmware

Firmware upgrade failure If the firmware upgrade fails, the device reloads the previous firmware. The most common reason is that the wrong firmware file has been uploaded. Check that the name of the firmware file corresponds to your device and try again.

Problems setting the IP address

The device is located on a different subnet If the IP address intended for the device and the IP address of the computer used to access the device are located on different subnets, you cannot set the IP address. Contact your network administrator to obtain an IP address.

The IP address is being used by another device Disconnect the Axis device from the network. Run the ping command (in a Command/DOS window, type `ping` and the IP address of the device):

- If you receive: `Reply from <IP address>: bytes=32; time=10...` this means that the IP address may already be in use by another device on the network. Obtain a new IP address from the network administrator and reinstall the device.
- If you receive: `Request timed out`, this means that the IP address is available for use with the Axis device. Check all cabling and reinstall the device.

Possible IP address conflict with another device on the same subnet The static IP address in the Axis device is used before the DHCP server sets a dynamic address. This means that if the same default static IP address is also used by another device, there may be problems accessing the device.

The device cannot be accessed from a browser

Cannot log in When HTTPS is enabled, ensure that the correct protocol (HTTP or HTTPS) is used when attempting to log in. You may need to manually type `http` or `https` in the browser's address field.

If the password for the user `root` is lost, the device must be reset to the factory default settings. See *Reset to factory default settings on page 19*.

The IP address has been changed by DHCP IP addresses obtained from a DHCP server are dynamic and may change. If the IP address has been changed, use AXIS IP Utility or AXIS Device Manager to locate the device on the network. Identify the device using its model or serial number, or by the DNS name (if the name has been configured).

The device is accessible locally but not externally

To access the device externally, we recommend using one of the following applications for Windows®:

- AXIS Companion: free of charge, ideal for small systems with basic surveillance needs.
- AXIS Camera Station: 30-day trial version free of charge, ideal for small to mid-size systems.

For instructions and download, go to axis.com/vms.

Performance considerations

When setting up your system, it is important to consider how various settings and situations affect the performance. Some factors affect the amount of bandwidth (the bitrate) required, others can affect the frame rate, and some affect both. If the load on the CPU reaches its maximum, this also affects the frame rate.

The following factors are the most important to consider:

AXIS A8207-VE Network Video Door Station

Troubleshooting

- High image resolution or lower compression levels result in images containing more data which in turn affects the bandwidth.
- Access by large numbers of Motion JPEG or unicast H.264 clients affects the bandwidth.
- Simultaneous viewing of different streams (resolution, compression) by different clients affects both frame rate and bandwidth.

Use identical streams wherever possible to maintain a high frame rate. Stream profiles can be used to ensure that streams are identical.

- Accessing Motion JPEG and H.264 video streams simultaneously affects both frame rate and bandwidth.
- Heavy usage of event settings affects the product's CPU load which in turn affects the frame rate.
- Using HTTPS may reduce frame rate, in particular if streaming Motion JPEG.
- Heavy network utilization due to poor infrastructure affects the bandwidth.
- Viewing on poorly performing client computers lowers perceived performance and affects frame rate.
- Running multiple AXIS Camera Application Platform (ACAP) applications simultaneously may affect the frame rate and the general performance.

AXIS A8207-VE Network Video Door Station



Specifications

Specifications

Front panel indicators and controls

When you connect the product to power, the indicator icons and the indicator strip light up for a few seconds.

Call indicator icons

Icon	Indication
	Steady blue when outgoing call initiated. Flashes blue when incoming call initiated.
	Steady amber for ongoing call.
	Steady green when door is open.

Card reader indicator stripe

The stripe indicates reader feedback.

Call button

You can use the built-in light around the call button to light up the faces of visitors.

LED indicators

Status LED	Indication
Green	Steady green for normal operation.

SD card slot

NOTICE

- Risk of damage to SD card. Do not use sharp tools, metal objects, or excessive force when inserting or removing the SD card. Use your fingers to insert and remove the card.
- Risk of data loss and corrupted recordings. Do not remove the SD card while the product is running. Unmount the SD card from the product's webpage before removal.

This product supports microSD/microSDHC/microSDXC cards.

For SD card recommendations, see axis.com.



microSD, microSDHC, and microSDXC Logos are trademarks of SD-3C LLC. microSD, microSDHC, microSDXC are trademarks or registered trademarks of SD-3C, LLC in the United States, other countries or both.

AXIS A8207-VE Network Video Door Station

Specifications

Buttons

Control button

The control button is used for:

- Resetting the product to factory default settings. See *Reset to factory default settings* on page 19.

Connectors

HDMI connector

Use the microHDMI™ connector to connect a display or public view monitor.

Network connector

RJ45 Ethernet connector with Power over Ethernet Plus (PoE+).

Audio connector

4-pin terminal block for audio input and output.

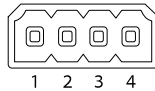

Function	Pin	Notes
Line in	1	Line in (mono)
GND	2	Audio ground
Line out	3	Line out
GND	4	Audio ground

Relay connector

8-pin terminal block for solid state relays that can be used in the following ways:

- As a standard relay that opens and closes auxiliary circuits.
- To control a lock directly.
- To control a lock through a safety relay. Using a safety relay on the secure side of the door prevents hotwiring.

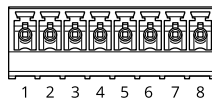

Function	Pin	Notes	Specifications
NO/NC	1	Normally open/normally closed For connecting relay devices. The two relay pins are galvanically separated from the rest of the circuitry.	Max current 1 A Max voltage 30 V DC

AXIS A8207-VE Network Video Door Station

Specifications

COM	2	Common	
24 V DC	3	For powering auxiliary equipment. Note: This pin can only be used as power out.	Output voltage 24 V DC Max current 50 mA ¹ Max current 350 mA ²
DC ground	4		0 V DC
NO/NC	5	Normally open/normally closed For connecting relay devices. The two relay pins are galvanically separated from the rest of the circuitry.	Max current 1 A Max voltage 30 V DC
COM	6	Common	
12 V DC	7	For powering auxiliary equipment. Note: This pin can only be used as power out.	Output voltage 12 V DC Max current 100 mA ³ Max current 700 mA ⁴
DC ground	8		0 V DC

1. When powered through Power over Ethernet IEEE 802.3af/802.3at Type 1 Class 3.
2. When powered through Power over Ethernet Plus (PoE+) IEEE 802.3at Type 2 Class 4 or DC power input.
3. When powered through Power over Ethernet IEEE 802.3af/802.3at Type 1 Class 3.
4. When powered through Power over Ethernet Plus (PoE+) IEEE 802.3at Type 2 Class 4 or DC power input.

Reader connector

4-pin terminal block for connecting external reader.

Function	Pin	Notes	Specifications
DC ground	1		0 V DC
12 V DC	2	For powering auxiliary equipment. Note: This pin can only be used as power out.	Output voltage 12 V DC
D0/A+	3	Wiegand: DATA0 output RS485: A+	
D1/B-	4	Wiegand: DATA1 output RS485: B-	

I/O connector

Use the I/O connector with external devices in combination with, for example, motion detection, event triggering, and alarm notifications. In addition to the 0 V DC reference point and power (DC output), the I/O connector provides the interface to:

Digital input – For connecting devices that can toggle between an open and closed circuit, for example PIR sensors, door/window contacts, and glass break detectors.

Digital output – For connecting external devices such as relays and LEDs. Connected devices can be activated by the VAPIX® Application Programming Interface, through an event or from the product's webpage.

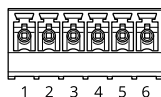

Function	Pin	Notes	Specifications
DC ground	1		0 V DC

AXIS A8207-VE Network Video Door Station

Specifications

DC output	2	Can be used to power auxiliary equipment. Note: This pin can only be used as power out.	12 V DC Max load = 50 mA
Configurable (Input or Output)	3-6	Digital input – Connect to pin 1 to activate, or leave floating (unconnected) to deactivate.	0 to max 30 V DC
		Digital output – Internally connected to pin 1 (DC ground) when active, and floating (unconnected) when inactive. If used with an inductive load, e.g., a relay, connect a diode in parallel with the load, to protect against voltage transients.	0 to max 30 V DC, open drain, 100 mA

Example

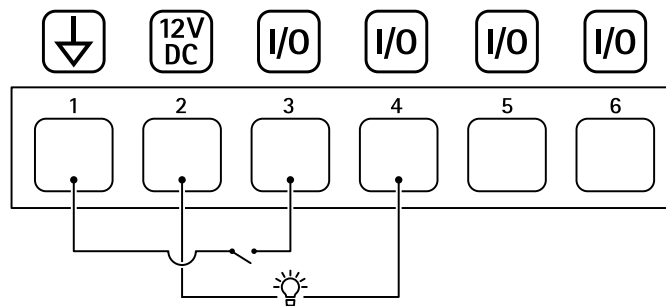

- 1 DC ground
- 2 DC output 12 V, max 50 mA
- 3 I/O configured as input
- 4 I/O configured as output
- 5 Configurable I/O
- 6 Configurable I/O

Power connector

2-pin terminal block for DC power input. Use a Safety Extra Low Voltage (SELV) compliant limited power source (LPS) with either a rated output power limited to ≤ 100 W or a rated output current limited to ≤ 5 A.

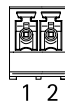

Function	Pin	Notes	Specifications
DC ground	1		0 V DC
DC input	2	For powering controller when not using Power over Ethernet. Note: This pin can only be used as power in.	8–28 V DC, max 22 W Max load on outputs 9 W

AXIS A8207-VE Network Video Door Station

Safety information

Safety information

Hazard levels

▲DANGER

Indicates a hazardous situation which, if not avoided, will result in death or serious injury.

▲WARNING

Indicates a hazardous situation which, if not avoided, could result in death or serious injury.

▲CAUTION

Indicates a hazardous situation which, if not avoided, could result in minor or moderate injury.

NOTICE

Indicates a situation which, if not avoided, could result in damage to property.

Other message levels

Important

Indicates significant information which is essential for the product to function correctly.

Note

Indicates useful information which helps in getting the most out of the product.

