

## **AXIS C1310-E Network Horn Speaker**

**User manual**

# AXIS C1310-E Network Horn Speaker

## Solution overview

---

### Solution overview

This manual describes how you make the device accessible to your audio system, and how to configure the device directly from its interface (for instance when you use the device without an audio or video management software).

If you are using an audio or video management software, you can use that software for configuring the device. The following management software are available for controlling your audio system:

- **AXIS Audio Manager Edge** – Audio management software for small systems. Comes pre-installed on all audio devices with a firmware equal to or higher than 10.0.
  - *AXIS Audio Manager Edge user manual*
- **AXIS Audio Manager Pro** – Advanced audio management software for large systems.
  - *AXIS Audio Manager Pro user manual*
- **AXIS Camera Station** – Advanced video management software for large systems.
  - *AXIS Camera Station user manual*
- **AXIS Companion** – Video management software for small systems.
  - *AXIS Companion user manual*

For more information, see *Audio management software*.



To watch this video, go to the web version of this document.

[help.axis.com/?&tpald=58287&tsection=solution-overview](http://help.axis.com/?&tpald=58287&tsection=solution-overview)

*An overview of how network audio works.*

# AXIS C1310-E Network Horn Speaker

## Installation

---

### Installation



To watch this video, go to the web version of this document.

*[help.axis.com/?etpiald=58287&tsection=solution-overview](http://help.axis.com/?etpiald=58287&tsection=solution-overview)*

# AXIS C1310-E Network Horn Speaker

## Get started

---

### Get started

#### Find the device on the network

To find Axis devices on the network and assign them IP addresses in Windows®, use AXIS IP Utility or AXIS Device Manager. Both applications are free and can be downloaded from [axis.com/support](http://axis.com/support).

For more information about how to find and assign IP addresses, go to *How to assign an IP address and access your device*.

#### Browser support

You can use the device with the following browsers:

	Chrome™	Firefox®	Edge™	Safari®
Windows®	recommended	recommended	✓	
macOS®	recommended	recommended	✓	✓
Linux®	recommended	recommended	✓	
Other operating systems	✓	✓	✓	✓*

\*To use AXIS OS web interface with iOS 15 or iPadOS 15, go to **Settings > Safari > Advanced > Experimental Features** and disable *NSURLSession Websocket*.

If you need more information about recommended browsers, go to *AXIS OS Portal*.

#### Access the device

1. Open a browser and enter the IP address or host name of the Axis device.
2. Enter the username and password. If you access the device for the first time, you must set the root password. See *Set a new password for the root account on page 4*.

#### Set a new password for the root account

##### Important

The default administrator username is **root**. If the password for root is lost, reset the device to factory default settings. See *Reset to factory default settings on page 35*



To watch this video, go to the web version of this document.  
[help.axis.com/?&tpid=58287&tsection=set-a-new-password-for-the-root-account](http://help.axis.com/?&tpid=58287&tsection=set-a-new-password-for-the-root-account)

*Support tip: Password security confirmation check*

1. Type a password. Follow the instructions about secure passwords. See *Secure passwords on page 5*.
2. Retype the password to confirm the spelling.

# AXIS C1310-E Network Horn Speaker

## Get started

---

3. Click **Save**. The password has now been configured.

### Secure passwords

#### Important

Axis devices send the initially set password in clear text over the network. To protect your device after the first login, set up a secure and encrypted HTTPS connection and then change the password.

The device password is the primary protection for your data and services. Axis devices do not impose a password policy as they may be used in various types of installations.

To protect your data we strongly recommend that you:

- Use a password with at least 8 characters, preferably created by a password generator.
- Don't expose the password.
- Change the password at a recurring interval, at least once a year.

# AXIS C1310-E Network Horn Speaker

## Additional settings

---

### Additional settings

#### Calibrate and run a remote speaker test

You can run a speaker test to verify from a remote location that a speaker is working as intended. The speaker performs the test by playing a series of test tones that are registered by the built-in microphone. Every time you run the test, the registered values are compared with the values that were registered during the calibration.

##### Note

The test must be calibrated from its mounted position at the installation site. If the speaker is moved or if its local surroundings change, for instance if a wall is built or removed, the speaker should be re-calibrated

During calibration, it is recommended that someone is physically present at the installation site to listen to the test tones and ensure that the test tones are not muffled or blocked by any unintended obstructions in the speaker's acoustic path.

1. Go to the device interface > **Audio** > **Speaker test**.
2. To calibrate the audio device, click **Calibrate**.

##### Note

Once the Axis product is calibrated, the speaker test can be run at any time.

3. To run the speaker test, click **Run the test**.

##### Note

It is also possible to run the calibration by pressing the control button on the physical device. See *Product overview on page 38* to identify the control button.

#### Set up direct SIP (P2P)

Use peer-to-peer when the communication is between a few user agents within the same IP network and there is no need for extra features that a PBX-server could provide. To better understand how P2P works, see *Peer-to-peer SIP (P2PSIP) on page 12*.

For more information about setting options, see *SIP on page 28*.

1. Go to **System** > **SIP** > **SIP settings** and select **Enable SIP**.
2. To allow the device to receive incoming calls, select **Allow incoming calls**.
3. Under **Call handling**, set the timeout and duration for the call.
4. Under **Ports**, enter the port numbers.
  - **SIP port** – The network port used for SIP communication. The signaling traffic through this port is non-encrypted. The default port number is 5060. Enter a different port number if required.
  - **TLS port** – The network port used for encrypted SIP communication. The signaling traffic through this port is encrypted with Transport Layer Security (TLS). The default port number is 5061. Enter a different port number if required.
  - **RTP start port** – Enter the port used for the first RTP media stream in a SIP call. The default start port for media transport is 4000. Some firewalls might block RTP traffic on certain port numbers. A port number must be between 1024 and 65535.
5. Under **NAT traversal**, select the protocols you want to enable for NAT traversal.

##### Note

Use NAT traversal when the device is connected to the network from behind a NAT router or a firewall. For more information see *NAT traversal on page 13*.

# AXIS C1310-E Network Horn Speaker

## Additional settings

---

6. Under **Audio**, select at least one audio codec with the desired audio quality for SIP calls. Drag-and-drop to change the priority.
7. Under **Additional**, select additional options.
  - **UDP-to-TCP switching** – Select to allow calls to switch transport protocols from UDP (User Datagram Protocol) to TCP (Transmission Control Protocol) temporarily. The reason for switching is to avoid fragmentation, and the switch can take place if a request is within 200 bytes of the maximum transmission unit (MTU) or larger than 1300 bytes.
  - **Allow via rewrite** – Select to send the local IP address instead of the router's public IP address.
  - **Allow contact rewrite** – Select to send the local IP address instead of the router's public IP address.
  - **Register with server every** – Set how often you want the device to register with the SIP server for the existing SIP accounts.
  - **DTMF payload type** – Changes the default payload type for DTMF.
8. Click **Save**.

## Set up SIP through a server (PBX)

Use a PBX-server when the communication should be between an infinite number of user agents within and outside the IP network. Additional features could be added to the setup depending on the PBX-provider. To better understand how P2P works, see *Private Branch Exchange (PBX) on page 12*.

For more information about setting options, see *SIP on page 28*.

1. Request the following information from your PBX provider:
  - User ID
  - Domain
  - Password
  - Authentication ID
  - Caller ID
  - Registrar
  - RTP start port
2. To add a new account, go to **System > SIP > SIP accounts** and click **+ Account**.
3. Enter the details you received from your PBX provider.
4. Select **Registered**.
5. Select a transport mode.
6. Click **Save**.
7. Set up the SIP settings the same way as for peer-to-peer. See *Set up direct SIP (P2P) on page 6* for more information.

## Set up rules for events

You can create rules to make your device perform actions when certain events occur. A rule consists of conditions and actions. The conditions can be used to trigger the actions. For example, the device can play an audio clip according to a schedule or when it receives a call, or send an email if the device changes IP address.

# AXIS C1310-E Network Horn Speaker

## Additional settings

---

To learn more, check out our guide *Get started with rules for events*.

### Send an email if a speaker test fails

In this example the audio device is configured to send an email to a defined recipient when a speaker test fails. The speaker test is configured to be performed 18:00 every day.

1. Set up a schedule for the speaker test:
  - 1.1 Go to the device interface > **System** > **Events** > **Schedules**.
  - 1.2 Create a schedule that starts at 18:00 and ends at 18:01 every day. Name it "Daily at 6pm".
2. Create an email recipient:
  - 2.1 Go to the device interface > **System** > **Events** > **Recipients**.
  - 2.2 Click **Add recipient**.
  - 2.3 Name the recipient "Speaker test recipients"
  - 2.4 Under **Type**, select **Email**.
  - 2.5 Under **Send email to**, enter the email addresses of the recipients. Use commas to separate multiple addresses.
  - 2.6 Enter the details for the email account of the sender.
  - 2.7 Click **Test** to send a test email.

#### Note

Some email providers have security filters that prevent users from receiving or viewing large attachments, from receiving scheduled emails and similar. Check the email provider's security policy to avoid delivery problems and locked email accounts.

- 2.8 Click **Save**.
3. Set up the automated speaker test:
  - 3.1 Go to the device interface > **System** > **Events** > **Rules**.
  - 3.2 Click **Add a rule**.
  - 3.3 Enter a name for the rule.
  - 3.4 Under **Condition**, select **Schedule** and select from the trigger list
  - 3.5 Under **Schedule**, select your schedule ("Daily at 6pm").
  - 3.6 Under **Action**, select **Run automatic speaker test**.
  - 3.7 Click **Save**.
4. Set up the condition for sending an email when the speaker test fails:
  - 4.1 Go to the device interface > **System** > **Events** > **Rules**.
  - 4.2 Click **Add a rule**.
  - 4.3 Enter a name for the rule.
  - 4.4 Under **Condition**, select **Speaker test result**.
  - 4.5 Under **Speaker test status**, select **Didn't pass the test**.
  - 4.6 Under **Action**, select **Send notification to email**.



# AXIS C1310-E Network Horn Speaker

## Additional settings

---

4.7 Under **Recipient**, select your recipient ("Speaker test recipients")

4.8 Enter a subject and a message, and click **Save**.

### Play audio when a camera detects motion

This example explains how to set up the audio device to play an audio clip when an Axis network camera detects motion.

#### Prerequisites

- The Axis audio device and Axis network camera are located on the same network.
- The motion detection application is configured and running in the camera.

1. Prepare an audio clip link:

1.1 Go to **Audio > Audio clips**.

1.2 Click  > **Create link** for an audio clip.

1.3 Set the volume and number of times to repeat the clip.

1.4 Click the copy icon to copy the link.

2. Create an action rule:

2.1 Go to **System > Events > Recipients**.

2.2 Click **+ Add recipient**.

2.3 Type a name for the recipient, for example "Speaker".

2.4 Select **HTTP** from the **Type** drop-down list.

2.5 Paste the configured link from the audio device in the **URL** field.

2.6 Enter the user name and password of the audio device.

2.7 Click **Save**.

2.8 Go to **Rules** and click **+ Add a rule**.

2.9 Type a name for the action rule, for example "Play clip".

2.10 From the **Condition** list, select a video motion detection alternative under **Applications**.

#### Note

If there are no options for video motion detection, then go to **Apps**, click **AXIS Video Motion Detection** and turn on motion detection.

2.11 From the **Action** list, select **Send notification through HTTP**.

2.12 Under **Recipient**, select your recipient.

2.13 Click **Save**.

### Stop audio with DTMF

This example explains how to:

- Configure DTMF on a device.
- Set up an event to stop the audio when a DTMF command is sent to the device.

# AXIS C1310-E Network Horn Speaker

## Additional settings

---

1. Go to **System > SIP > SIP settings**.
2. Make sure **Enable SIP** is turned on.  
If you need to turn it on, remember to click **Save** afterwards.
3. Go to **SIP accounts**.
4. Next to the SIP account, click  > **Edit**.
5. Under **DTMF**, click **+ DTMF sequence**.
6. Under **Sequence**, enter "1".
7. Under **Description**, enter "stop audio".
8. Click **Save**.
9. Go to **System > Events > Rules** and click **+ Add a rule**.
10. Under **Name**, enter "DTMF stop audio".
11. Under **Condition**, select **DTMF**.
12. Under **DTMF Event ID**, select **stop audio**.
13. Under **Action**, select **Stop playing audio clip**.
14. Click **Save**.

### Set up audio for incoming SIP calls

You can set up a rule that plays an audio clip when you receive a SIP call.

You can also set up an additional rule that answers the SIP call automatically after the audio clip has ended. This can be useful in cases where an alarm operator wants to call the attention of someone near an audio device and establish a line of communication. This is done by making a SIP call to the audio device, which will play an audio clip to alert the persons near the audio device. When the audio clip has stopped playing, the SIP call is automatically answered by the audio device and communication between the alarm operator and the persons near the audio device can take place.

Enable SIP settings:

1. Go to the device interface of the speaker, by entering its IP address in a web browser.
2. Go to **System > SIP > SIP settings** and select **Enable SIP**.
3. To allow the device to receive incoming calls, select **Allow incoming calls**.
4. Click **Save**.
5. Go to **SIP accounts**.
6. Next to the SIP account, click  > **Edit**.
7. Uncheck **Answer automatically**.

Play audio when a SIP call is received:

1. Go to **Settings > System > Events > Rules** and add a rule.
2. Type a name for the rule.
3. In the list of conditions, select **State**.

# AXIS C1310-E Network Horn Speaker

## Additional settings

---

4. In the list of states, select **Ring**.
5. In the list of actions, select **Play audio clip**.
6. In the list of clips, select the audio clip you want to play.
7. Select how many times to repeat the audio clip. 0 means "play once".
8. Click **Save**.

Answer the SIP call automatically after the audio clip has ended:

1. Go to **Settings > System > Events > Rules** and add a rule.
2. Type a name for the rule.
3. In the list of conditions, select **Audio clip playing**.
4. Check **Use this condition as a trigger**.
5. Check **Invert this condition**.
6. Click **+ Add a condition** to add a second condition to the event.
7. In the list of conditions, select **State**.
8. In the list of states, select **Ring**.
9. In the list of actions, select **Answer call**.
10. Click **Save**.

# AXIS C1310-E Network Horn Speaker

Learn more

---

## Learn more

### Session Initiation Protocol (SIP)

The Session Initiation Protocol (SIP) is used to set up, maintain and terminate VoIP calls. You can make calls between two or more parties, called SIP user agents. To make a SIP call you can use, for example, SIP phones, softphones or SIP-enabled Axis devices.

The actual audio or video is exchanged between the SIP user agents with a transport protocol, for example RTP (Real-Time Transport Protocol).

You can make calls on local networks using a peer-to-peer setup, or across networks using a PBX.

### Peer-to-peer SIP (P2PSIP)

The most basic type of SIP communication takes place directly between two or more SIP user agents. This is called peer-to-peer SIP (P2PSIP). If it takes place on a local network, all that's needed are the SIP addresses of the user agents. A typical SIP address in this case would be `sip:<local-ip>`.

Example

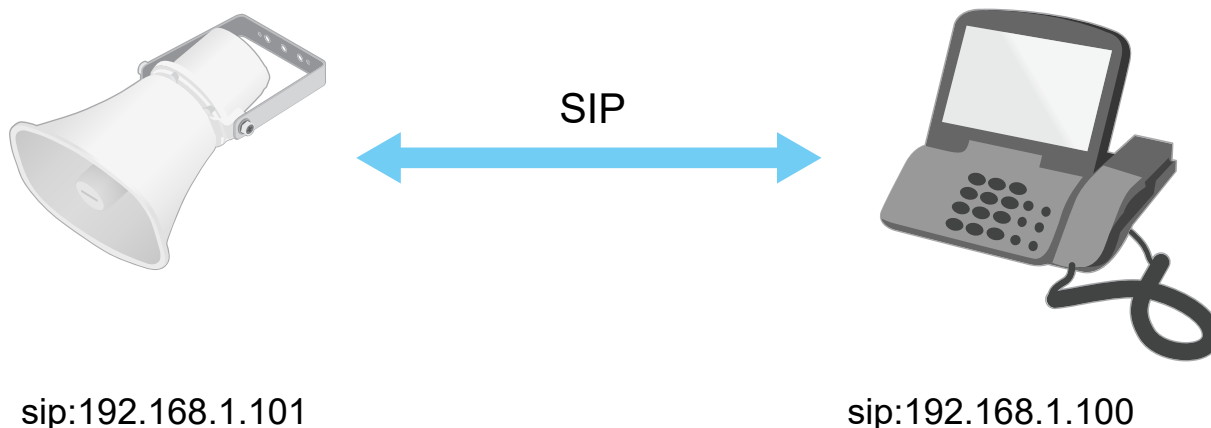

You can set up a SIP-enabled phone to call an audio device on the same network using a peer-to-peer SIP setup.

### Private Branch Exchange (PBX)

When you make SIP calls outside your local IP network, a Private Branch Exchange (PBX) can act as a central hub. The main component of a PBX is a SIP server, which is also referred to as a SIP proxy or a registrar. A PBX works like a traditional switchboard, showing the client's current status and allowing for example call transfers, voicemail, and redirections.

The PBX SIP server can be set up as a local entity or offsite. It can be hosted on an intranet or by a third party provider. When you make SIP calls between networks, calls are routed through a set of PBXs, that query the location of the SIP address to be reached.

Each SIP user agent registers with the PBX, and can then reach the others by dialing the correct extension. A typical SIP address in this case would be `sip:<user>@<domain>` or `sip:<user>@<registrar-ip>`. The SIP address is independent of its IP address and the PBX makes the device accessible as long as it is registered to the PBX.

Example

# AXIS C1310-E Network Horn Speaker

Learn more

---

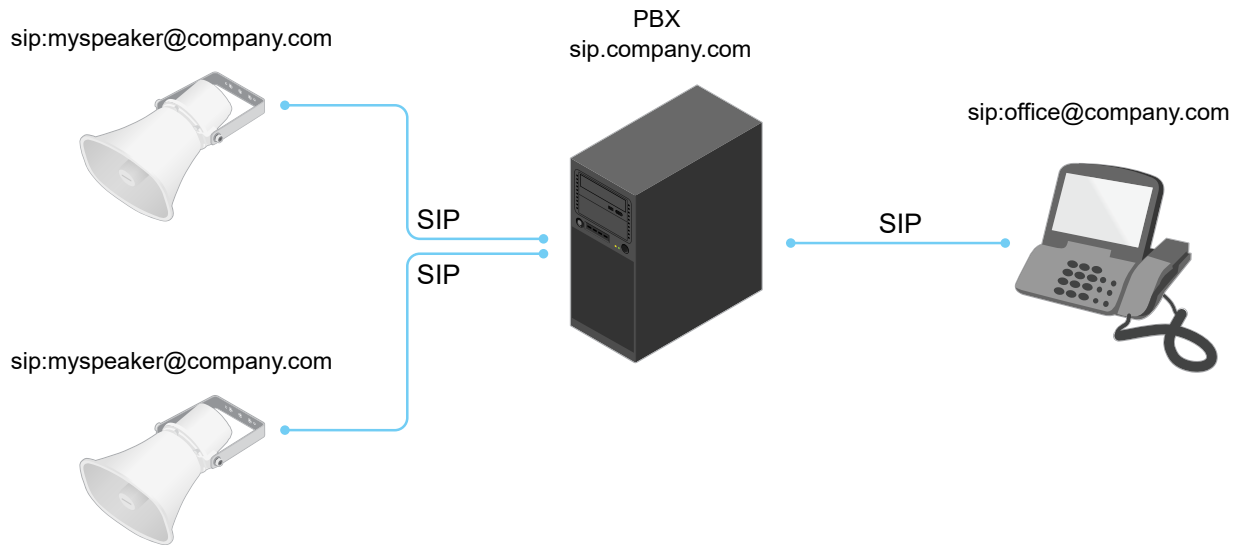

## NAT traversal

Use NAT (Network Address Translation) traversal when the Axis device is located on an private network (LAN) and you want to access it from outside of that network.

### Note

The router must support NAT traversal and UPnP®.

Each NAT traversal protocol can be used separately or in different combinations depending on the network environment.

- **ICE** (The ICE Interactive Connectivity Establishment) protocol increases the chances of finding the most efficient path to successful communication between peer devices. If you also enable STUN and TURN, you improve the ICE protocol's chances.
- **STUN** - STUN (Session Traversal Utilities for NAT) is a client-server network protocol that lets the Axis device determine if it is located behind a NAT or firewall, and if so obtain the mapped public IP address and port number allocated for connections to remote hosts. Enter the STUN server address, for example, an IP address.
- **TURN** - TURN (Traversal Using Relays around NAT) is a protocol that lets a device behind a NAT router or firewall receive incoming data from other hosts over TCP or UDP. Enter TURN server address and the login information.

## Applications

With applications you can get more out of your Axis device. AXIS Camera Application Platform (ACAP) is an open platform that makes it possible for third parties to develop analytics and other applications for Axis devices. Applications can be preinstalled on the device, available for download for free, or for a license fee. To find out more about available applications, downloads, trials and licenses, go to [axis.com/products/acap/application-gallery](http://axis.com/products/acap/application-gallery).

To find the user manuals for Axis applications, go to [help.axis.com](http://help.axis.com).

# AXIS C1310-E Network Horn Speaker

## The device interface









---

### The device interface

To reach the device interface, type the device's IP address in a web browser.

#### Note

Support for the features and settings described in this section varies between devices.

-  Show or hide the main menu.
-  Access the product help.
-  Change the language.
-  Set light theme or dark theme.
-  The user menu contains:
  - Information about the user who is logged in.
  -  **Change user** : Log out the current user and log in a new user.
  -  **Log out** : Log out the current user.
-  The context menu contains:
  - Analytics data**: Accept to share non-personal browser data.
  - Feedback**: Share any feedback to help us improve your user experience.
  - Legal**: View information about cookies and licenses.
  - About**: View device information, including firmware version and serial number.

### Status

#### NTP sync

Shows NTP synchronization information, including if the device is in sync with an NTP server and the time remaining until the next sync.

**NTP settings**: Click to go to the Date and time page where you can change the NTP settings.

#### Device info

Shows device information, including firmware version and serial number.

**Upgrade firmware**: Click to go to the Maintenance page where you can do a firmware upgrade.

#### Connected clients

The list shows all clients that are connected to the device.

 **Update**: Click to refresh the list.

# AXIS C1310-E Network Horn Speaker

## The device interface

---

### Audio

#### Overview

**Locate device:** Click to play a sound that helps you identify the speaker. For some products, a LED will flash on the device.

**Calibrate**  : Click to calibrate the speaker.

**Launch AXIS Audio Manager Edge:** Click to launch the application.

#### Device settings

**Input:** Turn on or off audio input. Shows the type of input.

**Gain:** Use the slider to change the gain. Click the microphone icon to mute or unmute.

**Output:** Shows the type of output.

**Gain:** Use the slider to change the gain. Click the speaker icon to mute or unmute.

#### Stream

**Encoding:** Select the encoding to use for the input source streaming. You can only choose encoding if audio input is turned on. If audio input is turned off, click **Enable audio input** to turn it on.

**Echo cancellation:** Turn on to remove echoes during two-way communication.

#### Audio clips

 **Add clip:** Click to add a new audio clip. You can use .au, .mp3, .opus, .vorbis, .wav files.

 Click to play the audio clip.

 Click to stop playing the audio clip.



The context menu contains:

- **Rename:** Change the name of the audio clip.
- **Create link:** Create a URL which, when used, plays the audio clip on the device. Specify the volume and number of times to play the clip.
- **Download:** Download the audio clip to your computer.
- **Delete:** Delete the audio clip from the device.

# AXIS C1310-E Network Horn Speaker

## The device interface

---

### Listen and record

 Click to listen.

 Click to start a continuous recording of the live audio stream. Click again to stop the recording. If a recording is ongoing, it will resume automatically after a reboot.

**Note**

You can only listen and record if input is turned on for the device. Go to **Audio > Device settings** to make sure that input is turned on.

 Click to show the storage that is configured for the device. To configure the storage you need to be logged in as an administrator.

### Audio site security

**CA certificate:** Select the certificate to use when you add devices to the audio site when TLS authentication is enabled in AXIS Audio Manager Edge.

**Save:** Click to activate and save your selection.

### Speaker test

You can use the speaker test to verify from a remote location that the speaker works as intended.

**Calibrate:** Click to calibrate the speaker before you test it for the first time. During calibration, the speaker plays a series of test tones that are registered by the built-in microphone. When you calibrate the speaker, it must be installed in its final position. If you move the speaker later on, or if its surroundings change, for example if a wall is built or removed, you need to recalibrate the speaker.

**Run the test:** Click to play the same series of test tones that were played during calibration, and compare them with the registered values from the calibration.

### Recordings

 Click to filter the recordings.

**From:** Show recordings done after a certain point in time.

**To:** Show recordings up until a certain point in time.

**Source** ⓘ : Show recordings based on source.

**Event:** Show recordings based on events.

**Storage:** Show recordings based on storage type.



# AXIS C1310-E Network Horn Speaker

## The device interface



---

**Ongoing recordings:** Show all ongoing recordings on the camera.

- Select to start a recording on the camera.
-  Choose which storage device to save to.
- Select to stop a recording on the camera.

**Triggered recordings** will end both when manually stopped and when the camera is shut down.

**Continuous recordings** will continue until manually stopped. Even if the camera is shut down, the recording will continue when the camera starts up again.

-  Click to play the recording.
-  Click to stop playing the recording.
-  Click to show more information and options about the recording.

**Set export range:** If you only want to export part of the recording, enter from when to when.

-  Click to delete the recording.

**Export:** Click to export (part of) the recording.

## Apps

-  **Add app:** Click to install a new app.

**Find more apps:** Click to go to an overview page of Axis apps.

**Allow unsigned apps:** Turn on to allow installation of unsigned apps.

### Note

The device's performance might be affected if you run several apps at the same time.

Use the switch next to the app name to start or stop the app.

**Open:** Click to access the app's settings. The available settings depend on the application. Some applications don't have any settings.

- ⋮ The context menu can contain one or more of the following options:
  - **Open-source license:** Click to view information about open-source licenses used in the app.
  - **App log:** Click to view a log of the app events. The log is helpful when you contact support.
  - **Activate license with a key:** If the app requires a license, you need to activate it. Use this option if your device doesn't have internet access.  
If you don't have a license key, go to [axis.com/products/analytics](https://axis.com/products/analytics). You need a license code and the Axis product serial number to generate a license key.

# AXIS C1310-E Network Horn Speaker

## The device interface

---

- **Activate license automatically:** If the app requires a license, you need to activate it. Use this option if your device has internet access. You need a license code to activate the license.
- **Deactivate the license:** Deactivate the license to use it in another device. If you deactivate the license, you also remove it from the device. To deactivate the license requires internet access.
- **Settings:** Configure the parameters.
- **Delete:** Delete the app permanently from the device. If you don't deactivate the license first, it remains active.

## System

### Date and time

The time format depends on the web browser's language settings.

#### Note

We recommend you to synchronize the device's date and time with an NTP server.

**Synchronization:** Select an option for synchronizing the device's date and time.

- **Automatic date and time (manual NTS KE servers):** Synchronize with the secure NTP key establishment servers connected to the DHCP server.
  - **Manual NTS KE servers:** Enter the IP address of one or two NTP servers. When you use two NTP servers, the device synchronizes and adapts its time based on input from both.
- **Automatic date and time (NTP servers using DHCP):** Synchronize with the NTP servers connected to the DHCP server.
  - **Fallback NTP servers:** Enter the IP address of one or two fallback servers.
- **Automatic date and time (manual NTP servers):** Synchronize with NTP servers of your choice.
  - **Manual NTP servers:** Enter the IP address of one or two NTP servers. When you use two NTP servers, the device synchronizes and adapts its time based on input from both.
- **Custom date and time:** Manually set the date and time. Click **Get from system** to fetch the date and time settings once from your computer or mobile device.

**Time zone:** Select which time zone to use. Time will be automatically adjusted for daylight saving time and standard time.

#### Note

The system uses the date and time settings in all recordings, logs and system settings.

## Network

### IPv4

**Assign IPv4 automatically:** Select to let the network router assign an IP address to the device automatically. We recommend automatic IP (DHCP) for most networks.

**IP address:** Enter a unique IP address for the device. Static IP addresses can be assigned at random within isolated networks, provided that each address is unique. To avoid conflicts, we recommend you to contact your network administrator before you assign a static IP address.

**Subnet mask:** Enter the subnet mask to define what addresses are inside the local area network. Any address outside the local area network goes through the router.

**Router:** Enter the IP address of the default router (gateway) used to connect devices that are attached to different networks and network segments.

### IPv6

**Assign IPv6 automatically:** Select to turn on IPv6 and to let the network router assign an IP address to the device automatically.

### Hostname

# AXIS C1310-E Network Horn Speaker

## The device interface

---

**Assign hostname automatically:** Select to let the network router assign a hostname to the device automatically.

**Hostname:** Enter the hostname manually to use as an alternative way of accessing the device. The Hostname is used in the server report and in the system log. Allowed characters are A-Z, a-z, 0-9 and -.

### DNS servers

**Assign DNS automatically:** Select to let the network router assign search domains and DNS server addresses to the device automatically. We recommend automatic DNS (DHCP) for most networks.

**Search domains:** When you use a hostname that is not fully qualified, click **Add search domain** and enter a domain in which to search for the hostname used by the device.

**DNS servers:** Click **Add DNS server** and enter the IP address of the DNS server. This provides the translation of hostnames to IP addresses on your network.

### HTTP and HTTPS

**Allow access through:** Select if a user is allowed to connect to the device through the HTTP, HTTPS, or both HTTP and HTTPS protocols.

HTTPS is a protocol that provides encryption for page requests from users and for the pages returned by the web server. The encrypted exchange of information is governed by the use of an HTTPS certificate, which guarantees the authenticity of the server.

To use HTTPS on the device, you must install an HTTPS certificate. Go to **System > Security** to create and install certificates.

#### Note

If you view encrypted web pages through HTTPS, you might experience a drop in performance, especially when you request a page for the first time.

**HTTP port:** Enter the HTTP port to use. Port 80 or any port in the range 1024-65535 are allowed. If you are logged in as an administrator, you can also enter any port in the range 1-1023. If you use a port in this range, you get a warning.

**HTTPS port:** Enter the HTTPS port to use. Port 443 or any port in the range 1024-65535 are allowed. If you are logged in as an administrator, you can also enter any port in the range 1-1023. If you use a port in this range, you get a warning.

**Certificate:** Select a certificate to enable HTTPS for the device.

### Network discovery protocols

**Bonjour®:** Turn on to allow automatic discovery on the network.

**Bonjour name:** Enter a friendly name to be visible on the network. The default name is the device name and MAC address.

**UPnP®:** Turn on to allow automatic discovery on the network.

**UPnP name:** Enter a friendly name to be visible on the network. The default name is the device name and MAC address.

**WS-Discovery:** Turn on to allow automatic discovery on the network.

### One-click cloud connection

# AXIS C1310-E Network Horn Speaker

## The device interface

One-click cloud connection (O3C) together with an O3C service provides easy and secure internet access to live and recorded video from any location. For more information, see [axis.com/end-to-end-solutions/hosted-services](http://axis.com/end-to-end-solutions/hosted-services).

### Allow O3C:

- **One-click:** The default setting. Press and hold the control button on the device to connect to an O3C service over the internet. You need to register the device with the O3C service within 24 hours after you press the control button. Otherwise, the device disconnects from the O3C service. Once you have registered the device, **Always** is enabled and the device stays connected to the O3C service.
- **Always:** The device constantly attempts to connect to an O3C service over the internet. Once you have registered the device, it stays connected to the O3C service. Use this option if the control button on the device is out of reach.
- **No:** Disables the O3C service.

**Proxy settings:** If needed, enter the proxy settings to connect to the proxy server.

**Host:** Enter the proxy server's address.

**Port:** Enter the port number used for access.

**Login and Password:** If needed, enter username and password for the proxy server.

### Authentication method:

- **Basic:** This method is the most compatible authentication scheme for HTTP. It's less secure than the **Digest** method because it sends the username and password unencrypted to the server.
- **Digest:** This method is more secure because it always transfers the password encrypted across the network.
- **Auto:** This option lets the device select the authentication method depending on the supported methods. It prioritizes the **Digest** method over the **Basic** method.

**Owner authentication key (OAK):** Click **Get key** to fetch the owner authentication key. This is only possible if the device is connected to the internet without a firewall or proxy.

## SNMP

The Simple Network Management Protocol (SNMP) allows remote management of network devices.

**SNMP:** Select the version of SNMP to use.

- **v1 and v2c:**
  - **Read community:** Enter the community name that has read-only access to all supported SNMP objects. The default value is **public**.
  - **Write community:** Enter the community name that has read/write access to all supported SNMP objects (except read-only objects). The default value is **write**.
  - **Activate traps:** Turn on to activate trap reporting. The device uses traps to send messages for important events or status changes to a management system. In the device interface, you can set up traps for SNMP v1 and v2c. Traps are automatically turned off if you change to SNMP v3 or turn off SNMP. If you use SNMP v3, you can set up traps through the SNMP v3 management application.
  - **Trap address:** Enter the IP address or host name of the management server.
  - **Trap community:** Enter the community to use when the device sends a trap message to the management system.
  - **Traps:**
    - **Cold start:** Sends a trap message when the device starts.
    - **Warm start:** Sends a trap message when you change an SNMP setting.
    - **Link up:** Sends a trap message when a link changes from down to up.
    - **Authentication failed:** Sends a trap message when an authentication attempt fails.

### Note

All Axis Video MIB traps are enabled when you turn on SNMP v1 and v2c traps. For more information, see [AXIS OS Portal > SNMP](#).

- **v3:** SNMP v3 is a more secure version, which provides encryption and secure passwords. To use SNMP v3, we recommend you to activate HTTPS, as the password is then sent through HTTPS. This also prevents unauthorized parties to access unencrypted SNMP v1 and v2c traps. If you use SNMP v3, you can set up traps through the SNMP v3 management application.

# AXIS C1310-E Network Horn Speaker

## The device interface

- **Password for the account "initial":** Enter the SNMP password for the account named "initial". Although the password can be sent without activating HTTPS, we don't recommend it. The SNMP v3 password can only be set once, and preferably only when HTTPS is enabled. Once the password is set, the password field is no longer displayed. To set the password again, you must reset the device to factory default settings.

## Security

### Certificates

Certificates are used to authenticate devices on a network. The device supports two types of certificates:

- **Client/server certificates**  
A client/server certificate validates the device's identity, and can be self-signed or issued by a Certificate Authority (CA). A self-signed certificate offers limited protection and can be used before a CA-issued certificate has been obtained.
- **CA certificates**  
You can use a CA certificate to authenticate a peer certificate, for example to validate the identity of an authentication server when the device connects to a network protected by IEEE 802.1X. The device has several pre-installed CA certificates.

These formats are supported:

- Certificate formats: .PEM, .CER, and .PFX
- Private key formats: PKCS#1 and PKCS#12

#### Important

If you reset the device to factory default, all certificates are deleted. Any pre-installed CA certificates are reinstalled.



Filter the certificates in the list.



Add certificate : Click to add a certificate.



The context menu contains:

- **Certificate information:** View an installed certificate's properties.
- **Delete certificate:** Delete the certificate.
- **Create certificate signing request:** Create a certificate signing request to send to a registration authority to apply for a digital identity certificate.

### IEEE 802.1x

IEEE 802.1x is an IEEE standard for port-based network admission control providing secure authentication of wired and wireless network devices. IEEE 802.1x is based on EAP (Extensible Authentication Protocol).

To access a network protected by IEEE 802.1x, network devices must authenticate themselves. The authentication is performed by an authentication server, typically a RADIUS server (for example FreeRADIUS and Microsoft Internet Authentication Server).

#### Certificates

When configured without a CA certificate, server certificate validation is disabled and the device tries to authenticate itself regardless of what network it is connected to.

When using a certificate, in Axis' implementation, the device and the authentication server authenticate themselves with digital certificates using EAP-TLS (Extensible Authentication Protocol - Transport Layer Security).

To allow the device to access a network protected through certificates, a signed client certificate must be installed on the device.

**Client certificate:** Select a client certificate to use IEEE 802.1x. The authentication server uses the certificate to validate the client's identity.

# AXIS C1310-E Network Horn Speaker

## The device interface

---

**CA certificate:** Select a CA certificate to validate the authentication server's identity. When no certificate is selected, the device tries to authenticate itself regardless of what network it is connected to.

**EAP identity:** Enter the user identity associated with the client certificate.

**EAPOL version:** Select the EAPOL version that is used in the network switch.

**Use IEEE 802.1x:** Select to use the IEEE 802.1x protocol.

### Prevent brute-force attacks

**Blocking:** Turn on to block brute-force attacks. A brute-force attack uses trial-and-error to guess login info or encryption keys.

**Blocking period:** Enter the number of seconds to block a brute-force attack.

**Blocking conditions:** Enter the number of authentication failures allowed per second before the block starts. You can set the number of failures allowed both on page level and device level.

### IP address filter

**Use filter:** Select to filter which IP addresses that are allowed to access the device.

**Policy:** Choose whether to **Allow** access or **Deny** access for certain IP addresses.

**Addresses:** Enter the IP numbers that are either allowed or denied access to the device. You can also use the CIDR format.

### Custom-signed firmware certificate

To install test firmware or other custom firmware from Axis on the device, you need a custom-signed firmware certificate. The certificate verifies that the firmware is approved by both the device owner and Axis. The firmware can only run on a specific device which is identified by its unique serial number and chip ID. Custom-signed firmware certificates can only be created by Axis, since Axis holds the key to sign them.

Click **Install** to install the certificate. You need to install the certificate before you install the firmware.

## Users



**Add user:** Click to add a new user. You can add up to 100 users.

**Username:** Enter a unique username.

**New password:** Enter a password for the user. Passwords must be 1 to 64 characters long. Only ASCII printable characters (code 32 to 126) are allowed in the password, for example letters, numbers, punctuation, and some symbols.

**Repeat password:** Enter the same password again.

**Role:**

- **Administrator:** Has full access to all settings. Administrators can also add, update, and remove other users.
- **Operator:** Has access to all settings except:
  - All **System** settings.
  - Adding apps.
- **Viewer:** Doesn't have access to change any settings.



The context menu contains:

**Update user:** Edit the user's properties.

**Delete user:** Delete the user. You can't delete the root user.

# AXIS C1310-E Network Horn Speaker

## The device interface

---

### Anonymous users

**Allow anonymous viewers:** Turn on to allow anyone to access the device as a viewer without having to log in with a user account.

**Allow anonymous PTZ operators:** Turn on to allow anonymous users to pan, tilt, and zoom the image.

### Events

#### Rules

A rule defines the conditions that must be met for the product to perform an action. The list shows all the currently configured rules in the product.

#### Note

You can create up to 256 action rules.



**Add a rule:** Click to create a rule.

**Name:** Enter a name for the rule.

**Wait between actions:** Enter the minimum time (hh:mm:ss) that must pass between rule activations. It is useful if the rule is activated by for example day-night mode conditions, to avoid that small light changes during sunrise and sunset activate the rule repeatedly.

**Condition:** Select a condition from the list. A condition must be met for the device to perform an action. If multiple conditions are defined, all of them must be met to trigger the action. For information about specific conditions, see *Get started with rules for events*.

**Use this condition as a trigger:** Select to make this first condition function only as a starting trigger. It means that once the rule is activated it remains active for as long as all the other conditions are met, no matter the state of the first condition. If you don't select this option, the rule will simply be active whenever all the conditions are met.

**Invert this condition:** Select if you want the condition to be the opposite of your selection.



**Add a condition:** Click to add an additional condition.

**Action:** Select an action from the list and enter its required information. For information about specific actions, see *Get started with rules for events*.

Your product may have some of the following pre-configured rules:

**Front-facing LED Activation: LiveStream:** When the microphone is turned on and a live stream is received, then the front-facing LED on the audio device will turn green.

**Front-facing LED Activation: Recording :** When the microphone is turned on and a recording is ongoing, then the front-facing LED on the audio device will turn green.

**Front-facing LED Activation: SIP :** When the microphone is turned on and a SIP call is active, then the front-facing LED on the audio device will turn green. SIP must be enabled on the audio device before this event can be triggered.

**Pre-announcement tone: Play tone on incoming call:** When a SIP call is made to the audio device, then a pre-defined audio clip is played. SIP must be enabled for the audio device. For the SIP caller to hear a ring tone while the audio clip is played, the SIP account for the audio device must be configured to not answer the call automatically.

**Pre-announcement tone: Answer call after incoming call-tone:** When the audio clip has ended, the incoming SIP-call is answered. SIP must be enabled for the audio device.

# AXIS C1310-E Network Horn Speaker

## The device interface

**Loud ringer** : When a SIP call is made to the audio device, a pre-defined audio clip is played as long as the rule is active. SIP must be enabled for the audio device.

### Recipients

You can set up your device to notify recipients about events or send files. The list shows all the recipients currently configured in the product, along with information about their configuration.

#### Note

You can create up to 20 recipients.



**Add a recipient:** Click to add a recipient.

**Name:** Enter a name for the recipient.

**Type:** Select from the list:

- **FTP**
  - **Host:** Enter the server's IP address or hostname. If you enter a hostname, make sure that a DNS server is specified under **System > Network > IPv4 and IPv6**.
  - **Port:** Enter the port number used by the FTP server. The default is 21.
  - **Folder:** Enter the path to the directory where you want to store files. If this directory doesn't already exist on the FTP server, you will get an error message when uploading files.
  - **Username:** Enter the username for the login.
  - **Password:** Enter the password for the login.
  - **Use temporary file name:** Select to upload files with temporary, automatically generated filenames. The files get renamed to the desired names when the upload completes. If the upload is aborted/interrupted, you don't get any corrupt files. However, you probably still get the temporary files. This way you know that all files that have the desired name, are correct.
  - **Use passive FTP:** Under normal circumstances the product simply requests the target FTP server to open the data connection. The device actively initiates both the FTP control and data connections to the target server. This is normally needed if there is a firewall between the device and the target FTP server.
- **HTTP**
  - **URL:** Enter the network address to the HTTP server and the script that will handle the request. For example: `http://192.168.254.10/cgi-bin/notify.cgi`.
  - **Username:** Enter the username for the login.
  - **Password:** Enter the password for the login.
  - **Proxy:** Turn on and enter the required information if a proxy server must be passed to connect to the HTTP server.
- **HTTPS**
  - **URL:** Enter the network address to the HTTPS server and the script that will handle the request. For example: `https://192.168.254.10/cgi-bin/notify.cgi`.
  - **Validate server certificate:** Select to validate the certificate that was created by HTTPS server.
  - **Username:** Enter the username for the login.
  - **Password:** Enter the password for the login.
  - **Proxy:** Turn on and enter the required information if a proxy server must be passed to connect to the HTTPS server.
- **Network storage**

You can add network storage such as a NAS (Network Attached Storage) and use it as a recipient to store files. The files are stored in the Matroska (MKV) file format.

  - **Host:** Enter the IP address or hostname for the network storage.
  - **Share:** Enter the name of the share on the host.
  - **Folder:** Enter the path to the directory where you want to store files.
  - **Username:** Enter the username for the login.
  - **Password:** Enter the password for the login.
- **SFTP**
  - **Host:** Enter the server's IP address or hostname. If you enter a hostname, make sure that a DNS server is specified under **System > Network > IPv4 and IPv6**.



# AXIS C1310-E Network Horn Speaker

## The device interface

- **Port:** Enter the port number used by the SFTP server. The default is 22.
  - **Folder:** Enter the path to the directory where you want to store files. If this directory doesn't already exist on the SFTP server, you will get an error message when uploading files.
  - **Username:** Enter the username for the login.
  - **Password:** Enter the password for the login.
  - **SSH host public key type (MD5):** Enter the fingerprint of the remote host's public key (a 32-digit hexadecimal string). The SFTP client supports SFTP servers using SSH-2 with RSA, DSA, ECDSA, and ED25519 host key types. RSA is the preferred method during negotiation, followed by ECDSA, ED25519, and DSA. Make sure to enter the right MD5 host key that is used by your SFTP server. While the Axis device supports both MD5 and SHA-256 hash keys, we recommend using SHA-256 due to stronger security over MD5. For more information on how to configure an SFTP server with an Axis device, go to the *AXIS OS Portal*.
  - **SSH host public key type (SHA256):** Enter the fingerprint of the remote host's public key (a 43-digit Base64 encoded string). The SFTP client supports SFTP servers using SSH-2 with RSA, DSA, ECDSA, and ED25519 host key types. RSA is the preferred method during negotiation, followed by ECDSA, ED25519, and DSA. Make sure to enter the right MD5 host key that is used by your SFTP server. While the Axis device supports both MD5 and SHA-256 hash keys, we recommend using SHA-256 due to stronger security over MD5. For more information on how to configure an SFTP server with an Axis device, go to the *AXIS OS Portal*.
  - **Use temporary file name:** Select to upload files with temporary, automatically generated filenames. The files get renamed to the desired names when the upload completes. If the upload is aborted/interrupted, you don't get any corrupt files. However, you probably still get the temporary files. This way you know that all files that have the desired name, are correct.
- **SIP or VMS**  :
- SIP: Select to make a SIP call.
  - VMS: Select to make a VMS call.
    - **From SIP account:** Select from the list.
    - **To SIP address:** Enter the SIP address.
    - **Test:** Click to test that your call settings works.
- **Email**
- **Send email to:** Enter the email address to send emails to. To enter multiple addresses, use commas to separate them.
  - **Send email from:** Enter the email address of the sending server.
  - **Username:** Enter the username for the mail server. Leave this field empty if the mail server does not require authentication.
  - **Password:** Enter the password for the mail server. Leave this field empty if the mail server does not require authentication.
  - **Email server (SMTP):** Enter the name of the SMTP server, for example smtp.gmail.com, smtp.mail.yahoo.com.
  - **Port:** Enter the port number for the SMTP server, using values in the range 0-65535. The default value is 587.
  - **Encryption:** To use encryption, select either SSL or TLS.
  - **Validate server certificate:** If you use encryption, select to validate the identity of the device. The certificate can be self-signed or issued by a Certificate Authority (CA).
  - **POP authentication:** Turn on to enter the name of the POP server, for example pop.gmail.com.

### Note

Some email providers have security filters that prevent users from receiving or viewing large amount of attachments, from receiving scheduled emails and similar. Check the email provider's security policy to avoid your email account being locked or missing out on your expected emails.

- **TCP**
  - **Host:** Enter the server's IP address or hostname. If you enter a hostname, make sure that a DNS server is specified under **System > Network > IPv4 and IPv6**.
  - **Port:** Enter the port number used to access the server.

**Test:** Click to test the setup.



The context menu contains:

**View recipient:** Click to view all the recipient details.

**Copy recipient:** Click to copy a recipient. When you copy, you can make changes to the new recipient.

**Delete recipient:** Click to delete the recipient permanently.

# AXIS C1310-E Network Horn Speaker

## The device interface

---

### Schedules

Schedules and pulses can be used as conditions in rules. The list shows all the schedules and pulses currently configured in the product, along with information about their configuration.



Add schedule: Click to create a schedule or pulse.

### Manual trigger

The manual trigger is used to manually trigger a rule. The manual trigger can for example be used to validate actions during product installation and configuration.

### MQTT

MQTT (Message Queuing Telemetry Transport) is a standard messaging protocol for the Internet of Things (IoT). It was designed for simplified IoT integration and is used in a wide variety of industries to connect remote devices with a small code footprint and minimal network bandwidth. The MQTT client in Axis device firmware can simplify integration of data and events produced in the device to systems which are not video management systems (VMS).

Set up the device as an MQTT client. MQTT communication is based on two entities, the clients and the broker. The clients can send and receive messages. The broker is responsible for routing messages between clients.

You can learn more about MQTT in *AXIS OS Portal*.

### MQTT client

**Connect:** Turn on or off the MQTT client.

**Status:** Shows the current status of the MQTT client.

#### Broker

**Host:** Enter the hostname or IP address of the MQTT server.

**Protocol:** Select which protocol to use.

**Port:** Enter the port number.

- 1883 is the default value for **MQTT over TCP**
- 8883 is the default value for **MQTT over SSL**
- 80 is the default value for **MQTT over WebSocket**
- 443 is the default value for **MQTT over WebSocket Secure**

**Username:** Enter the username that the client will use to access the server.

**Password:** Enter a password for the username.

**Client ID:** Enter a client ID. The client identifier is sent to the server when the client connects to it.

**Clean session:** Controls the behavior at connection and disconnection time. When selected, the state information is discarded at connect and disconnect.

**Keep alive interval:** The keep alive interval enables the client to detect when the server is no longer available without having to wait for the long TCP/IP timeout.

**Timeout:** The time interval in seconds to allow a connect to complete. Default value: 60

**Device topic prefix:** Used in the default values for the topic in the connect message and LWT message on the **MQTT client** tab, and in the publication conditions on the **MQTT publication** tab.

**Reconnect automatically:** Specifies whether the client should reconnect automatically after a disconnect.

# AXIS C1310-E Network Horn Speaker

## The device interface

---

### Connect message

Specifies if a message should be sent out when a connection is established.

**Send message:** Turn on to send messages.

**Use default:** Turn off to enter your own default message.

**Topic:** Enter the topic for the default message.

**Payload:** Enter the content for the default message.

**Retain:** Select to keep the state of client on this Topic

**QoS:** Change the QoS layer for the packet flow.

### Last Will and Testament message

The Last Will Testament (LWT) lets a client provide a testament along with its credentials when connecting to the broker. If the client disconnects ungracefully at some point later (maybe because his power source died), it can let the broker deliver a message to other clients. This LWT message has the same form as an ordinary message and gets routed via the same mechanics.

**Send message:** Turn on to send messages.

**Use default:** Turn off to enter your own default message.

**Topic:** Enter the topic for the default message.

**Payload:** Enter the content for the default message.

**Retain:** Select to keep the state of client on this Topic

**QoS:** Change the QoS layer for the packet flow.

### MQTT publication

**Use default topic prefix:** Select to use the default topic prefix, that is defined in the device topic prefix in the MQTT client tab.

**Include topic name:** Select to include the topic that describes the condition in the MQTT topic.

**Include topic namespaces:** Select to include ONVIF topic namespaces in the MQTT topic.

**Include serial number:** Select to include the device's serial number in the MQTT payload.



**Add condition:** Click to add a condition.

**Retain:** Defines which MQTT messages are sent as retained.

- **None:** Send all messages as non-retained.
- **Property:** Send only stateful messages as retained.
- **All:** Send both stateful and stateless messages as retained.

**QoS:** Select the desired level for the MQTT publication.

### MQTT subscriptions

# AXIS C1310-E Network Horn Speaker

## The device interface

---



**Add subscription:** Click to add a new MQTT subscription.

**Subscription filter:** Enter the MQTT topic that you want to subscribe to.

**Use device topic prefix:** Add the subscription filter as prefix to the MQTT topic.

**Subscription type:**

- **Stateless:** Select to convert MQTT messages into a stateless message.
- **Stateful:** Select to convert MQTT messages into a condition. The payload is used as the state.

**QoS:** Select the desired level for the MQTT subscription.

## SIP

### SIP settings

Session Initiation Protocol (SIP) is used for interactive communication sessions between users. The sessions can include audio and video.

**Enable SIP:** Check this option to make it possible to initiate and receive SIP calls.

**Allow incoming calls:** Check this option to allow incoming calls from other SIP devices.

#### Call handling

- **Call timeout:** Set the maximum time a call can last before it ends if there is no answer (max 10 min).
- **Incoming call duration:** Set the maximum time an incoming call can last (max 10 min).
- **End calls after:** Set the maximum time that a call can last (max 60 min). Select **Infinite call duration** if you don't want to limit the length of a call.

#### Ports

A port number must be between 1024 and 65535.

- **SIP port:** The network port used for SIP communication. The signaling traffic through this port is non-encrypted. The default port number is 5060. Enter a different port number if required.
- **TLS port:** The network port used for encrypted SIP communication. The signaling traffic through this port is encrypted with Transport Layer Security (TLS). The default port number is 5061. Enter a different port number if required.
- **RTP start port:** The network port used for the first RTP media stream in a SIP call. The default start port number is 4000. Some firewalls block RTP traffic on certain port numbers.

#### NAT traversal

Use NAT (Network Address Translation) traversal when the device is located on an private network (LAN) and you want to make it available from outside of that network.

#### Note

For NAT traversal to work, the router must support it. The router must also support UPnP®.

Each NAT traversal protocol can be used separately or in different combinations depending on the network environment.

- **ICE:** The ICE (Interactive Connectivity Establishment) protocol increases the chances of finding the most efficient path to successful communication between peer devices. If you also enable STUN and TURN, you improve the ICE protocol's chances.
- **STUN:** STUN (Session Traversal Utilities for NAT) is a client-server network protocol that lets the device determine if it is located behind a NAT or firewall, and if so obtain the mapped public IP address and port number allocated for connections to remote hosts. Enter the STUN server address, for example, an IP address.
- **TURN:** TURN (Traversal Using Relays around NAT) is a protocol that lets a device behind a NAT router or firewall receive incoming data from other hosts over TCP or UDP. Enter the TURN server address and the login information.

#### Audio

# AXIS C1310-E Network Horn Speaker

## The device interface

### Note

- **Audio codec priority:** Select at least one audio codec with the desired audio quality for SIP calls. Drag-and-drop to change the priority.

The selected codecs must match the call recipient codec, since the recipient codec is decisive when a call is made.

### Additional

- **Audio direction:** Select allowed audio directions.
- **UDP-to-TCP switching:** Select to allow calls to switch transport protocols from UDP (User Datagram Protocol) to TCP (Transmission Control Protocol) temporarily. The reason for switching is to avoid fragmentation, and the switch can take place if a request is within 200 bytes of the maximum transmission unit (MTU) or larger than 1300 bytes.
- **Allow via rewrite:** Select to send the local IP address instead of the router's public IP address.
- **Allow contact rewrite:** Select to send the local IP address instead of the router's public IP address.
- **Register with server every:** Set how often you want the device to register with the SIP server for the existing SIP accounts.
- **DTMF payload type:** Changes the default payload type for DTMF.

## SIP accounts

All current SIP accounts are listed under **SIP accounts**. For registered accounts, the colored circle lets you know the status.

- The account is successfully registered with the SIP server.
- There is a problem with the account. Possible reasons can be authorization failure, that the account credentials are wrong, or that the SIP server can't find the account.

The **peer to peer (default)** account is an automatically created account. You can delete it if you create at least one other account and set that account as default. The default account is always used when a VAPIX® Application Programming Interface (API) call is made without specifying which SIP account to call from.



**Account:** Click to create a new SIP account.

- **Active:** Select to be able to use the account.
- **Make default:** Select to make this the default account. There must be a default account, and there can only be one default account.
- **Name:** Enter a descriptive name. This can, for example, be a first and last name, a role, or a location. The name is not unique.
- **User ID:** Enter the unique extension or phone number assigned to the device.
- **Peer-to-peer:** Use for direct calls to another SIP device on the local network.
- **Registered:** Use for calls to SIP devices outside the local network, through a SIP server.
- **Domain:** If available, enter the public domain name. It will be shown as part of the SIP address when calling other accounts.
- **Password:** Enter the password associated with the SIP account for authenticating against the SIP server.
- **Authentication ID:** Enter the authentication ID used for authenticating against the SIP server. If it is the same as the user ID, you don't need to enter the authentication ID.
- **Caller ID:** The name which is presented to the recipient of calls from the device.
- **Registrar:** Enter the IP address for the registrar.
- **Transport mode:** Select the SIP transport mode for the account: UPD, TCP, or TLS. When you select TLS, you get the option to use media encryption.
- **Media encryption (only with transport mode TLS):** Select the type of encryption for media (audio and video) in SIP calls.
- **Certificate (only with transport mode TLS):** Select a certificate.
- **Verify server certificate (only with transport mode TLS):** Check to verify the server certificate.
- **Secondary SIP server:** Turn on if you want the device to try to register on a secondary SIP server if registration on the primary SIP server fails.
- **Answer automatically:** Select to automatically answer an incoming call.
- **SIP secure:** Select to use Secure Session Initiation Protocol (SIPS). SIPS uses the TLS transport mode to encrypt traffic.
- **Proxies**

-  **Proxy:** Click to add a proxy.

# AXIS C1310-E Network Horn Speaker

## The device interface

- **Prioritize:** If you have added two or more proxies, click to prioritize them.
- **Server address:** Enter the IP address of the SIP proxy server.
- **Username:** If required, enter the username for the SIP proxy server.
- **Password:** If required, enter the password for the SIP proxy server.
- **Video** ⓘ
  - **View area:** Select the view area to use for video calls. If you select none, the native view is used.
  - **Resolution:** Select the resolution to use for video calls. The resolution affects the required bandwidth.
  - **Frame rate:** Select the number of frames per second for video calls. The frame rate affects the required bandwidth.
  - **H.264 profile:** Select the profile to use for video calls.
- **DTMF**
  - **Use RTP (RFC2833):** Select to allow dual-tone multifrequency (DTMF) signaling, other tone signals and telephony events in RTP packets.
  - **Use SIP INFO (RFC2976):** Select to include the INFO method to the SIP protocol. The INFO method adds optional application layer information, generally related to the session.
  - **+ DTMF sequence:** Click to add an action rule triggered by touch-tone. You must activate the action rule in the **Events** tab.
  - **Sequence:** Enter the characters to trigger the action rule. Allowed characters: 0–9, A–D, #, and \*.
  - **Description:** Enter a description of the action to be triggered.

### SIP test call

**SIP account:** Select which account to make the test call from.

**SIP address:** Enter a SIP address and click  to make a test call and verify that the account works.

## Storage

### Network storage

**Add network storage:** Click to add a network share where you can save recordings.

- **Address:** Enter the IP address or host name of the host server, typically a NAS (Network Attached Storage). We recommend you to configure the host to use a fixed IP address (not DHCP since a dynamic IP address can change) or that you use DNS. Windows SMB/CIFS names are not supported.
- **Network share:** Enter the name of the shared location on the host server. Several Axis devices can use the same network share, since each device gets its own folder.
- **User:** If the server requires a login, enter the username. To log in to a specific domain server, type `DOMAIN\username`.
- **Password:** If the server requires a login, enter the password.
- **SMB version:** Select the SMB storage protocol version to connect to the NAS. If you select **Auto**, the device tries to negotiate one of the secure versions SMB: 3.02, 3.0, or 2.1. Select 1.0 or 2.0 to connect to older NAS that don't support higher versions. You can read more about SMB support in Axis devices [here](#).
- **Add share even if connection test fails:** Select to add the network share even if an error is discovered during the connection test. The error can be, for example, that you didn't enter a password even though the server requires one.

**Remove network storage:** Click to remove the connection to the network share. This removes all settings for the network share.

**Write protect:** Turn on to stop writing to the network share and protect recordings from being removed. You can't format a write-protected network share.

**Ignore:** Turn on to stop storing recordings on the network share.

**Retention time:** Select how long to keep recordings, to limit the amount of old recordings or to comply with regulations regarding data storage. If the network storage becomes full, old recordings are removed before the selected time period has passed.

### Tools

- **Test connection:** Test the connection to the network share.
- **Format:** Format the network share, for example when you need to quickly erase all data. cifs is the available file system option.

# AXIS C1310-E Network Horn Speaker

## The device interface

---

Click **Use tool** to activate the selected tool.

### ONVIF

#### ONVIF users

ONVIF (Open Network Video Interface Forum) is a global interface standard that makes it easier for end-users, integrators, consultants, and manufacturers to take advantage of the possibilities offered by network video technology. ONVIF enables interoperability between different vendor products, increased flexibility, reduced cost and future-proof systems.

When you create an ONVIF user, you automatically enable ONVIF communication. Use the username and password for all ONVIF communication with the device. For more information see the Axis Developer Community at [axis.com](http://axis.com).



**Add user:** Click to add a new ONVIF user.

**Username:** Enter a unique username.

**New password:** Enter a password for the user. Passwords must be 1 to 64 characters long. Only ASCII printable characters (code 32 to 126) are allowed in the password, for example letters, numbers, punctuation, and some symbols.

**Repeat password:** Enter the same password again

**Role:**

- **Administrator:** Has full access to all settings. Administrators can also add, update, and remove other users.
- **Operator:** Has access to all settings except:
  - All **System** settings.
  - Adding apps.
- **Media user:** Allows access to the video stream only.



The context menu contains:

**Update user:** Edit the user's properties.

**Delete user:** Delete the user. You can't delete the root user.

#### ONVIF media profiles

An ONVIF media profile consists of a set of configurations that you can use to change media stream settings.



**Add media profile:** Click to add a new ONVIF media profile.

**profile\_x:** Click a profile to edit.

### Detectors

#### Audio detection

These settings are available for each audio input.

**Sound level:** Adjust the sound level to a value from 0–100, where 0 is the most sensitive and 100 the least sensitive. Use the activity indicator as a guide when you set the sound level. When you create events, you can use the sound level as a condition. You can choose to trigger an action if the sound level rises above, falls below or passes the set value.

### Accessories

#### I/O ports

# AXIS C1310-E Network Horn Speaker



## The device interface



Use digital input to connect external devices that can toggle between an open and closed circuit, for example PIR sensors, door or window contacts, and glass break detectors.

Use digital output to connect external devices such as relays and LEDs. You can activate connected devices through the VAPIX® Application Programming Interface or in the device interface.

### Port

**Name:** Edit the text to rename the port.

**Direction:**  indicates that the port is an input port.  indicates that it's an output port. If the port is configurable, you can click the icons to change between input and output.

**Normal state:** Click  open circuit, and  for closed circuit.

**Current state:** Shows the current state of the port. The input or output is activated when the current state is different from the normal state. An input on the device has an open circuit when it's disconnected or when there is a voltage above 1 V DC.

### Note

During restart the output circuit is open. When the restart is complete, the circuit goes back to the normal position. If you change any settings on this page, the output circuits go back to their normal positions regardless of any active triggers.

**Supervised**  : Turn on to make it possible to detect and trigger actions if someone tampers with the connection to digital I/O devices. In addition to detecting if an input is open or closed, you can also detect if someone has tampered with it (that is, cut or shorted). To supervise the connection requires additional hardware (end-of-line resistors) in the external I/O loop.

## Logs

### Reports and logs

#### Reports

- **View the device server report:** Click to show information about the product status in a pop-up window. The Access Log is automatically included in the Server Report.
- **Download the device server report:** Click to download the server report. It creates a .zip file that contains a complete server report text file in UTF-8 format, as well as a snapshot of the current live view image. Always include the server report .zip file when you contact support.
- **Download the crash report:** Click to download an archive with detailed information about the server's status. The crash report contains information that is in the server report as well as detailed debug information. This report might contain sensitive information such as network traces. It can take several minutes to generate the report.

#### Logs

- **View the system log:** Click to show information about system events such as device startup, warnings and critical messages.
- **View the access log:** Click to show all failed attempts to access the device, for example when a wrong login password is used.

### Network trace

#### Important

A network trace file might contain sensitive information, for example certificates or passwords.

A network trace file can help you troubleshoot problems by recording activity on the network. Select the duration of the trace in seconds or minutes, and click **Download**.



# AXIS C1310-E Network Horn Speaker

## The device interface

---

### Remote system log

Syslog is a standard for message logging. It allows separation of the software that generates messages, the system that stores them, and the software that reports and analyzes them. Each message is labeled with a facility code, which indicates the software type generating the message, and assigned a severity level.



**Server:** Click to add a new server.

**Host:** Enter the hostname or IP address of the server.

**Format:** Select which syslog message format to use.

- RFC 3164
- RFC 5424

**Protocol:** Select the protocol and port to use:

- UDP (Default port is 514)
- TCP (Default port is 601)
- TLS (Default port is 6514)

**Severity:** Select which messages to send when triggered.

**CA certificate set:** See the current settings or add a certificate.

### Plain config

Plain config is for advanced users with experience of Axis device configuration. Most parameters can be set and edited from this page.

## Maintenance

**Restart:** Restart the device. This does not affect any of the current settings. Running applications restart automatically.

**Restore:** Return *most* settings to the factory default values. Afterwards you must reconfigure the device and apps, reinstall any apps that didn't come preinstalled, and recreate any events and PTZ presets.

#### Important

The only settings saved after restore are:

- Boot protocol (DHCP or static)
- Static IP address
- Default router
- Subnet mask
- 802.1X settings
- O3C settings

**Factory default:** Return *all* settings to the factory default values. Afterwards you must reset the IP address to make the device accessible.

#### Note

All Axis device firmware is digitally signed to ensure that you only install verified firmware on your device. This further increases the overall minimum cybersecurity level of Axis devices. For more information, see the white paper "Signed firmware, secure boot, and security of private keys" at [axis.com](http://axis.com).

# AXIS C1310-E Network Horn Speaker

## The device interface

---

**Firmware upgrade:** Upgrade to a new firmware version. New firmware releases can contain improved functionality, bug fixes, and completely new features. We recommend you to always use the latest release. To download the latest release, go to [axis.com/support](http://axis.com/support).

When you upgrade, you can choose between three options:

- **Standard upgrade:** Upgrade to the new firmware version.
- **Factory default:** Upgrade and return all settings to the factory default values. When you choose this option, you can't revert to the previous firmware version after the upgrade.
- **Autorollback:** Upgrade and confirm the upgrade within the set time. If you don't confirm, the device reverts to the previous firmware version.

**Firmware rollback:** Revert to the previously installed firmware version.

# AXIS C1310-E Network Horn Speaker

## Troubleshooting

---

### Troubleshooting

#### Reset to factory default settings

##### Important

Reset to factory default should be used with caution. A reset to factory default resets all settings, including the IP address, to the factory default values.

To reset the product to the factory default settings:

1. Disconnect power from the product.
2. Press and hold the control button while reconnecting power. See *Product overview on page 38*.
3. Keep the control button pressed for 10 seconds until the status LED indicator turns amber for the second time.
4. Release the control button. The process is complete when the status LED indicator turns green. The product has been reset to the factory default settings. If no DHCP server is available on the network, the default IP address is 192.168.0.90.
5. Use the installation and management software tools, assign an IP address, set the password, and access the product.

You can also reset parameters to factory default through the device's webpage. Go to **Maintenance > Factory default** and click **Default**.

#### Check the current firmware version

Firmware is the software that determines the functionality of network devices. When you troubleshoot a problem, we recommend you to start by checking the current firmware version. The latest firmware version might contain a correction that fixes your particular problem.

To check the current firmware:

1. Go to the device interface > **Status**.
2. See the firmware version under **Device info**.

#### Upgrade the firmware

##### Important

- Preconfigured and customized settings are saved when you upgrade the firmware (provided that the features are available in the new firmware) although this is not guaranteed by Axis Communications AB.
- Make sure the device remains connected to the power source throughout the upgrade process.

##### Note

When you upgrade the device with the latest firmware in the active track, the product receives the latest functionality available. Always read the upgrade instructions and release notes available with each new release before you upgrade the firmware. To find the latest firmware and the release notes, go to [axis.com/support/firmware](https://axis.com/support/firmware).

1. Download the firmware file to your computer, available free of charge at [axis.com/support/firmware](https://axis.com/support/firmware).
2. Log in to the device as an administrator.
3. Go to **Maintenance > Firmware upgrade** and click **Upgrade**.

When the upgrade has finished, the product restarts automatically.

# AXIS C1310-E Network Horn Speaker

## Troubleshooting

---

### Technical issues, clues and solutions

If you can't find what you're looking for here, try the troubleshooting section at [axis.com/support](http://axis.com/support).

#### Problems upgrading the firmware

---

**Firmware upgrade failure** If the firmware upgrade fails, the device reloads the previous firmware. The most common reason is that the wrong firmware file has been uploaded. Check that the name of the firmware file corresponds to your device and try again.

#### Problems setting the IP address

---

**The device is located on a different subnet** If the IP address intended for the device and the IP address of the computer used to access the device are located on different subnets, you cannot set the IP address. Contact your network administrator to obtain an IP address.

**The IP address is being used by another device** Disconnect the Axis device from the network. Run the ping command (in a Command/DOS window, type `ping` and the IP address of the device):

- If you receive: `Reply from <IP address>: bytes=32; time=10...` this means that the IP address may already be in use by another device on the network. Obtain a new IP address from the network administrator and reinstall the device.
- If you receive: `Request timed out`, this means that the IP address is available for use with the Axis device. Check all cabling and reinstall the device.

**Possible IP address conflict with another device on the same subnet** The static IP address in the Axis device is used before the DHCP server sets a dynamic address. This means that if the same default static IP address is also used by another device, there may be problems accessing the device.

#### The device cannot be accessed from a browser

---

**Cannot log in** When HTTPS is enabled, ensure that the correct protocol (HTTP or HTTPS) is used when attempting to log in. You may need to manually type `http` or `https` in the browser's address field.

If the password for the user `root` is lost, the device must be reset to the factory default settings. See *Reset to factory default settings on page 35*.

**The IP address has been changed by DHCP** IP addresses obtained from a DHCP server are dynamic and may change. If the IP address has been changed, use AXIS IP Utility or AXIS Device Manager to locate the device on the network. Identify the device using its model or serial number, or by the DNS name (if the name has been configured).

#### The device is accessible locally but not externally

---

To access the device externally, we recommend using one of the following applications for Windows®:

- AXIS Camera Station: 30-day trial version free of charge, ideal for small to mid-size systems.

For instructions and download, go to [axis.com/vms](http://axis.com/vms).

#### Problems with sound files

---

**Can't upload media clip** The following audio clip formats are supported:

- au file format, encoded in  $\mu$ -law and sampled with 8 or 16 kHz.
- wav file format, encoded in PCM audio. It supports encoding as 8 or 16-bit mono or stereo and sample rate of 8 to 48 kHz.
- mp3 file format, in mono or stereo with bitrate of 64 kbps to 320 kbps and sample rate of 8 to 48 kHz.

# AXIS C1310-E Network Horn Speaker

## Troubleshooting

---

Media clips are played with different volumes      A sound file is recorded with a certain gain. If your audio clips have been created with different gains, they will be played with a different loudness. Make sure that you use clips that have the same gain.

### Performance considerations

When setting up your system, it is important to consider how various settings and situations affect the amount of needed bandwidth (the bitrate) required.

The following factors are the most important to consider:

- Heavy network utilization due to poor infrastructure affects the bandwidth.
- Running multiple AXIS Camera Application Platform (ACAP) applications simultaneously may affect the general performance.

# AXIS C1310-E Network Horn Speaker

## Specifications

### Specifications

#### Product overview

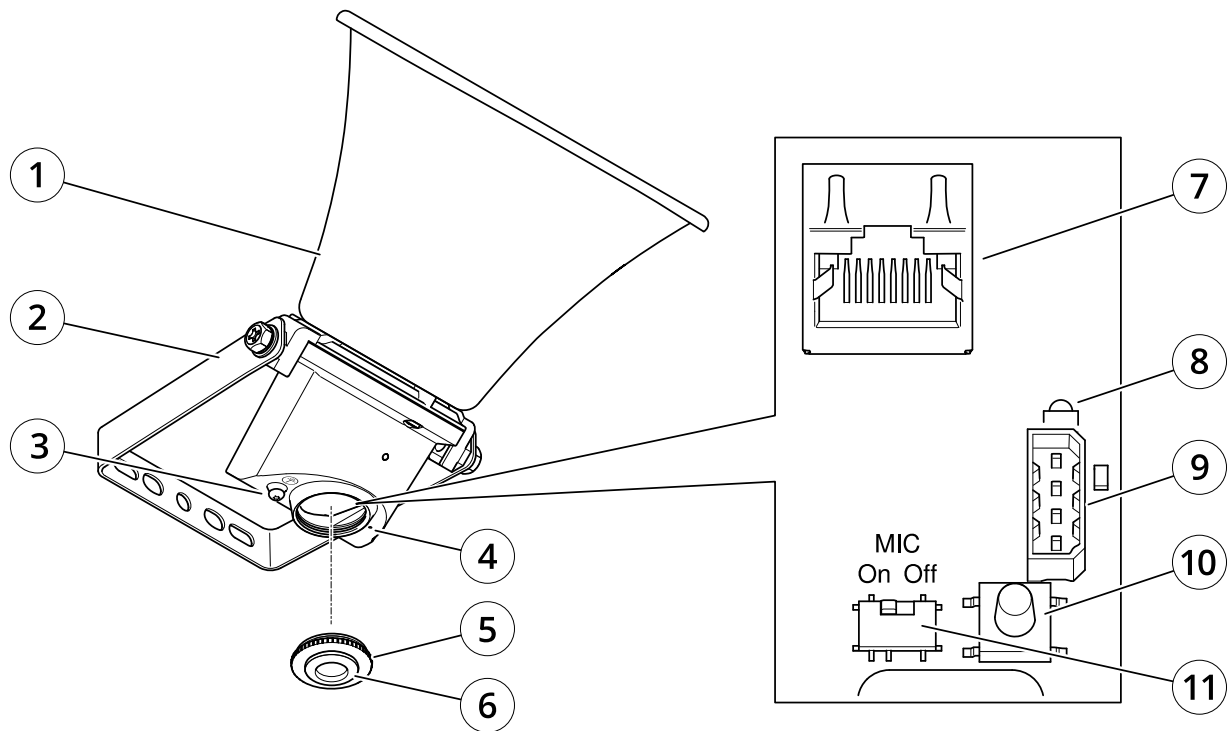

- 1 Horn
- 2 Bracket
- 3 Protective earth terminal
- 4 Microphone
- 5 Cap
- 6 Gasket
- 7 Network connector
- 8 Status LED indicator
- 9 I/O port
- 10 Control button
- 11 Microphone disable switch

#### LED indicators

Status LED	Indication
Unlit	Unlit for normal operation.
Green	Steady green for normal operation.
Amber	Steady during startup and when restoring settings.
Red	Slow flash for failed upgrade.

# AXIS C1310-E Network Horn Speaker

## Specifications

### Buttons

#### Control button

The control button is used for:

- Calibrating the speaker test. Press and release the control button and a test tone is played.
- Resetting the product to factory default settings. See *Reset to factory default settings on page 35*.

#### Microphone disable switch

For location of the microphone disable switch, see *Product overview on page 38*.

The microphone disable switch is used to mechanically turn the microphone ON or OFF. The factory default setting for this switch is ON.

### Connectors

#### Protective earth terminal

##### **⚠ DANGER**

Risk of electric shock. The product shall be grounded using a grounding wire. Make sure both ends of the grounding wire are in contact with their respective grounding surfaces.

Make sure the grounding wire is as short as possible to make the current path as short as possible.

#### Network connector

RJ45 Ethernet connector with Power over Ethernet (PoE).

##### **NOTICE**

The product shall be connected using a shielded network cable (STP). All cables connecting the product to the network shall be intended for their specific use. Make sure that the network devices are installed in accordance with the manufacturer's instructions. For information about regulatory requirements, see the Installation Guide at [www.axis.com](http://www.axis.com).

#### I/O connector

Use the I/O connector with external devices in combination with, for example, motion detection, event triggering, and alarm notifications. In addition to the 0 V DC reference point and power (12 V DC output), the I/O connector provides the interface to:

**Digital input** – For connecting devices that can toggle between an open and closed circuit, for example PIR sensors, door/window contacts, and glass break detectors.

**Digital output** – For connecting external devices such as relays and LEDs. Connected devices can be activated by the VAPIX® Application Programming Interface, through an event or from the product's webpage.

4-pin terminal block

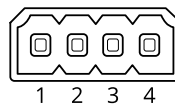

Function	Pin	Notes	Specifications
DC ground	1		0 V DC

# AXIS C1310-E Network Horn Speaker

## Specifications

DC output	2	Can be used to power auxiliary equipment. Note: This pin can only be used as power out.	12 V DC Max load = 25 mA
Digital Input	3	Connect to pin 1 to activate, or leave floating (unconnected) to deactivate.	0 to max 30 V DC
Digital Output	4	Internally connected to pin 1 (DC ground) when active, and floating (unconnected) when inactive. If used with an inductive load, e.g., a relay, connect a diode in parallel with the load, to protect against voltage transients.	0 to max 30 V DC, open drain, 100 mA

Example

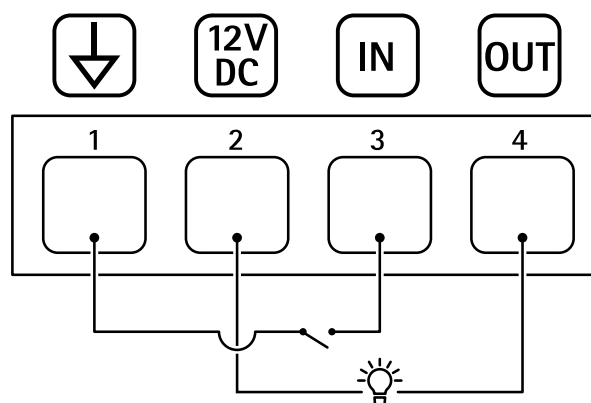

- 1 DC ground
- 2 DC output 12 V, max 25 mA
- 3 Digital input
- 4 Digital output



# AXIS C1310-E Network Horn Speaker

## API commands

---

### API commands

VAPIX® is Axis' own open API (Application Programming Interface). You can control almost all functionality available in Axis devices through VAPIX®. To get access to the complete VAPIX® documentation, join Axis Developer Community at [axis.com/developer-community](http://axis.com/developer-community)

Enter the commands in a web browser, and replace <deviceIP> with the IP address or host name of your device.

#### Important

The API commands execute immediately. If you restore or reset your device all settings will be lost. For example action rules.

#### Example

Restart the device

#### Request

```
http://<deviceIP>/axis-cgi/restart.cgi
```

#### Example

Restore the device. The request returns most settings to default values, but keeps the IP number.

#### Request

```
http://<deviceIP>/axis-cgi/factorydefault.cgi
```

#### Example

Reset the device. The request returns all settings including IP number to default values.

#### Request

```
http://<deviceIP>/axis-cgi/hardfactorydefault.cgi
```

#### Example

See a list of all device parameters.

#### Request

```
http://<deviceIP>/axis-cgi/param.cgi?action=list
```

#### Example

Get a debug archive

#### Request

```
http://<deviceIP>/axis-cgi/debug/debug.tgz
```

#### Example

Get a server report

#### Request

```
http://<deviceIP>/axis-cgi/serverreport.cgi
```

#### Example

Capture a network trace of 300 seconds

#### Request

```
http://<deviceIP>/axis-cgi/debug/debug.tgz?cmd=pcapdump&duration=300
```

#### Example

Enable FTP

#### Request

```
http://<deviceIP>/axis-cgi/param.cgi?action=update&Network.FTP.Enabled=yes
```

#### Example

# AXIS C1310-E Network Horn Speaker

## API commands

---

Disable FTP

**Request**

`http://<deviceIP>/axis-cgi/param.cgi?action=update&Network.FTP.Enabled=no`

Example

Enable SSH

**Request**

`http://<deviceIP>/axis-cgi/param.cgi?action=update&Network.SSH.Enabled=yes`

Example

Disable SSH

**Request**

`http://<deviceIP>/axis-cgi/param.cgi?action=update&Network.SSH.Enabled=no`

