

AXIS Companion Dome WV

User Manual

AXIS Companion Dome WV

About AXIS Companion Dome WV

About AXIS Companion Dome WV

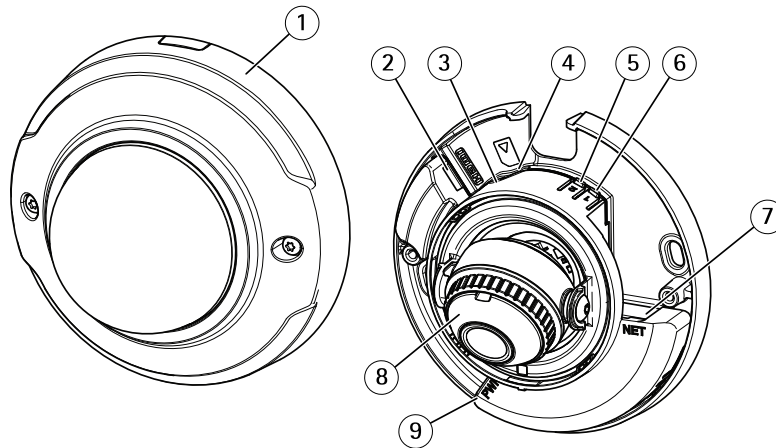

- 1 Dome cover
- 2 HDMI connector
- 3 Status LED
- 4 microSD card slot
- 5 WLAN pairing button (2)
- 6 Control button (1)
- 7 Network connector
- 8 Focus ring
- 9 Power Connector

HDMI connector for public view monitor

The HDMI connector can be connected to a public view monitor. The monitor can be used for live viewing only. The HDMI connector is not activated by default, see *How to activate the HDMI connector on page 9*

AXIS Companion Dome WV

The AXIS Companion solution

The AXIS Companion solution

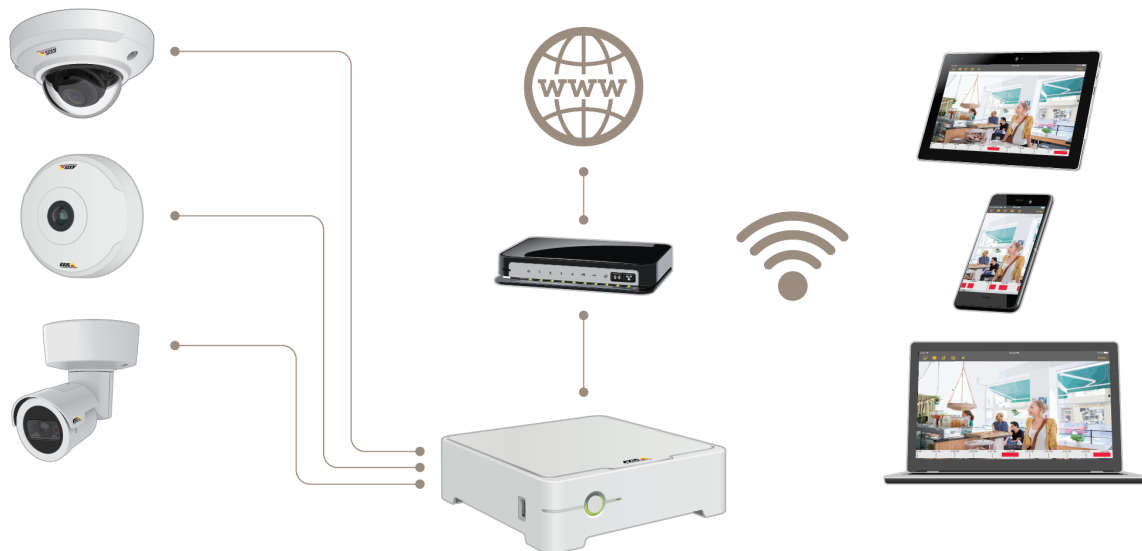

AXIS Companion is a complete end-to-end surveillance solution designed to meet the requirements of small systems with basic surveillance requirements.

An AXIS Companion solution can consist of:

- AXIS Companion cameras, Axis IP cameras and encoders with firmware 8.40 or higher.
- AXIS Companion recorders.
- Axis system accessories, such as memory cards and switches.
- AXIS Companion software for Windows computers as well as mobile devices and TV streaming devices (iOS and Android).

Learn more about AXIS Companion

For video tutorials and web apps, visit axis.com/products/axis-companion/how-it-works

System recommendations

- OS: Windows 8 64-bit
- CPU: Intel Core i5
- RAM: 4 GB
- Graphics card: 256 MB onboard video memory
- Graphics card driver: Always use the latest version
- Network: 100 Mbps

AXIS Companion Dome WV

The AXIS Companion solution

- Internet access is required during system setup and management (live and recorded video available offline)
- Uninterruptible Power Supply (UPS)
- Mobile devices: iOS 13 or Android 7

AXIS Companion Dome WV

Get started with AXIS Companion

Get started with AXIS Companion

Note

Internet access is required during the system setup.

Installation overview:

1. *Register a MyAxis account on page 5*
2. *Install the hardware on page 6*
3. *Install the desktop app on page 6*
4. *Create a site on page 7*
5. *Install the mobile app on page 8*

Result of system installation:

- The firmware is upgraded on all Axis devices.
- A password is set for the devices.
- The recordings are enabled with default settings.
- The remote access is enabled.

Register a MyAxis account

Register a MyAxis account at axis.com/my-axis/login.

You can make your MyAxis account more secure by activating multi-factor authentication (MFA). MFA is a security system that adds another layer of verification to ensure the user's identity.

Activate MFA:

1. Go to <http://auth.axis.com/user-center/account/security-settings>.
2. Turn on **2-Step verification**.

You are redirected to a login page.

3. Log in with your **MyAxis** credentials.

MFA is now active.

Log in when MFA is active:

1. Log in to your **MyAxis** account.

An email is sent to you.

2. Open the email and click **Authenticate**.

If you didn't receive an email, then check if it's in your spam folder. If it's not there, then contact IT support.

AXIS Companion Dome WV

Get started with AXIS Companion

Install the hardware



To watch this video, go to the web version of this document.

www.axis.com/products/online-manual/22816#t10169308

Installation video for the product.

1. Install your camera hardware.
2. Connect the recorder to your network via the LAN port.

Note

If you have no recorder, then you need a camera with an SD card if you want to be able to record video.

3. Connect the cameras to the recorder's integrated PoE switch or an external PoE switch.
4. Connect the computer to the same network as the recorder.
5. Connect the power supply to the recorder.

Important

You must first connect the power cord to the recorder, and then connect the power cord to the power outlet.

6. Wait a few minutes for the recorder and cameras to boot up before proceeding.

⚠CAUTION

Keep the recorder in a well ventilated environment and with plenty of empty space around the recorder to avoid overheating.

Install the desktop app

1. Go to axis.com/products/axis-companion and click **Download** to download the AXIS Companion desktop app for Windows.
2. Sign in using your *MyAxis* account.
3. Read the license agreement, and select one of the alternatives to proceed.
4. Save the file to a location of your choice.
5. Open the file, and click **Run** to start the installation.
6. If you want to allow the app to make changes on your device, click **Yes**.
7. Select language and click **OK**.
8. Follow the setup wizard.

AXIS Companion Dome WV

Get started with AXIS Companion

Create a site



To watch this video, go to the web version of this document.

www.axis.com/products/online-manual/22816#t10112114

A site is a single point of entry to a surveillance solution, for example all cameras in a store. You can keep track of several sites through a single MyAxis account.

Note

If you have used an earlier version of AXIS Companion, then you might have devices that are not supported in AXIS Companion version 4. Unsupported devices include third-party NAS devices and old Axis devices with a firmware that can't be updated to 5.50 or later. The wizard will inform you about any such issues and help you to address them.

Note

Sites that were created in an earlier version than AXIS Companion version 4, will not appear in the list of sites. You can read the Migration Guide (available on the support web page) for more information.

1. Start the AXIS Companion desktop app.
2. Sign in with your *MyAxis account*.
3. Click **Get started**.
4. Name your site and enter your company name.
5. Click **Next**.
6. Select the devices you want to add to your site.

If any devices are password-protected, then you must enter the password for them before they can be selected.

Note

If you have devices that are not supported, then you can click **Read more** to find out why they are not supported.

7. Click **Next**.
8. Enter a password.
This password is used for accessing the device webpages or offline mode in the AXIS Companion mobile app.
9. Click **Next**.
10. On the **Ready to install** page, there might be a list of cameras that need to be restored. If so, click the **Restore device** link to fix the issue on the device webpage.
11. Click **Finish** and wait while AXIS Companion configures the cameras.

Note

The configuration may take several minutes.

AXIS Companion Dome WV

Get started with AXIS Companion

For getting-started video tutorials, see *AXIS Companion tutorials*.

Install the mobile app

You can use the AXIS Companion mobile app to set up your system and control it from anywhere. Real-time alert notifications keep you aware of any suspicious activity. You can also view and export video recordings.

1. Go to your App store or Google play.
2. Search for **AXIS Companion 4** and download the app.
3. Sign in to AXIS Companion with your *MyAxis account*.

To find out more on how to use the app, see *AXIS Companion tutorials*.

AXIS Companion Dome WV

Daily use



Daily use

Connect the camera to a wireless network



1. Press and very quickly release the WLAN pairing button on the camera.
2. Press the WLAN pairing button on the wireless access point within 120 seconds from pushing the button on the camera.
3. Make sure the LED indicator shows steady green for 10 seconds, this means that the camera is connected.
4. Add the camera to your site, see *Add cameras to your site on page 18*.

If the wireless access point does not support push-button configuration, you have to configure the wireless network manually, see *Configure the wireless network manually on page 9*.

Configure the wireless network manually

1. Use a network cable to connect the camera to the network.
2. Make sure the access point is up and running.
3. Add the camera to your site, see *Add cameras to your site on page 18*.
4. Go to  and **Camera properties**  and log in to the product's webpage.
5. Go to **Settings > System > Wireless**.
6. In the list, select the wireless network or go to **Add another network** and add it manually with the SSID.
7. Enter the password for the access point.
8. Click **Save**.
9. Disconnect the network cable from the camera.
10. Make sure the LED indicator shows steady green for 10 seconds, this means that the camera is connected.
11. In AXIS Companion, check that you can access the camera.

How to activate the HDMI connector

1. Go to  and **Camera properties**  and log in to the product's webpage.
2. Go to **Settings > System > Maintenance**.
3. Select **Default** and wait for the camera to restart.
4. Go through the initial setup dialogue.
5. In the drop-down menu **Select a Capture Mode**, select **1080p (HDMI)**.
6. Go back to Axis Companion client.
7. Go to  and remove the camera, see *Remove a camera from your site on page 18*.
8. Add the camera again, see *Add cameras to your site on page 18*.

AXIS Companion Dome WV

Daily use

How to connect an HDMI monitor

1. If the HDMI connector is not activated, see *How to activate the HDMI connector on page 9*.
2. Connect the public view monitor to the HDMI connector.
3. Enable mirroring under **Settings > Stream**.

Access your cameras

1. Sign in to AXIS Companion on a computer or a mobile device using your *MyAxis account*.
2. Enter the site that contains your cameras.

Find out more at *AXIS Companion tutorials*.

View live video



To watch this video, go to the web version of this document.
www.axis.com/products/online-manual/22816#t10074647

1. Go to 
2. Select which camera you want to view.

To watch a video of how to zoom, pan and take snapshots, see the *AXIS Companion tutorials*.

Play a recording



To watch this video, go to the web version of this document.
www.axis.com/products/online-manual/22816#t10074285

1. Go to 

AXIS Companion Dome WV

Daily use

2. Use the timeline and calendar to find the recording.
3. Select the camera in the timeline and move the playback marker to the desired time.



Note

When you move the playback marker, the video image is updated continuously. This makes it easy for you to find a specific moment in the recording.

4. Click **Play**.

To watch a video of how to browse and play recordings, see the *AXIS Companion tutorials*.

Save a recording

1. Go to  > .
2. Select start and end times for a camera recording.
3. Select which cameras to save recordings from.
4. To save to a USB drive on an AXIS S3008 Recorder, select the **Save to recorder USB** checkbox.
5. Save the recording.

To watch a video of how to save recordings, see the *AXIS Companion tutorials*.

Play a saved recording

To play a saved recording, open it with AXIS File Player.

When you save a recording, the AXIS File Player will be saved in the same folder. The AXIS File Player has a timeline showing what time the recording was made.

Validate a saved recording

You can validate a recording to confirm that the timestamp and images have not been manipulated after the recording was first saved. For this purpose, a digital signature will be included in the file when you save a recording. You can add a password to the digital signature for increased security.

Protect your digital signature with a password:

1. In AXIS Companion, go to  > **Customize**.
2. Under **Recordings**, select **Show digital signature options when saving recordings**.

When saving a recording now, the **Digital signature** window will appear, allowing you to choose a password for the signature.

Validate a recording:

1. Open the saved recording with AXIS File Player.
2. Click **Tools** and select **Verify digital signature**.
3. Enter password, if a password was applied to the signature, and click **OK**.

A window appears to inform whether or not the recording is valid.

AXIS Companion Dome WV



Daily use

Take a snapshot

Take a snapshot from live view:

- Click 



Take a snapshot from recordings:

1. Use the timeline and calendar to find the recording.
2. Select the camera in the timeline and move the playback marker to the desired time.
3. Click  to start investigation mode.
 - Investigation mode allows you to step through the recorded video, frame by frame, to find the exact moment when an incident happened and take a snapshot from that moment.
4. To find the incident, click on the thumbnails to step 30, 15, 5 or 1 frames backward (top panel) or forward (bottom panel). You can also move the slider.
5. When satisfied, click  to take a snapshot.
 - For most cameras the snapshot will contain the entire camera image, regardless of the zoom level. For cameras with a dewarped image, the snapshot will be the zoomed-in image.

Change the folder where snapshots are saved:

1. Go to  > Customize.
2. Change the settings under **Snapshots**.

Adjust the image settings

1. Go to  > Cameras.
2. Click  > **Image settings** for the camera you want to adjust.

You can control the image by adjusting settings like:

- Appearance
- Exposure
- Overlay
- Day & Night
- Privacy mask
- Focus & zoom

Configure the video quality

You can configure the video quality to suit your image quality requirements and bandwidth usage. Video quality settings affect motion recording, continuous recording and live view.

AXIS Companion Dome WV

Daily use

1. Go to  > Cameras.
2. Right-click the camera you want to configure and select **Video Quality Settings**.
3. Edit the profile settings for:
 - **High** (resolutions with an image width above 640 pixels)
 - **Low** (resolutions with an image width up to 640 pixels)
 - **Axis Mobile Streaming**
4. Select **Axis Mobile Streaming** to improve playback performance for thumbnails and mobile apps.
 - **Axis Mobile Streaming** is activated when there is only one **High** profile active and the resolution is set for HD (1280x720) or above. Selecting **Axis Mobile Streaming** slightly increases storage usage.
 - When playing recordings, only those recorded with **Axis Mobile Streaming** enabled can toggle between **High** and **Low**.
5. Click **OK** to save.

Configure video motion detection



Recording only when motion is detected saves considerably on disk space and bandwidth, compared to continuous recording.

If the motion detection is triggered too often, you can adjust the settings to ignore parts of the view or certain types of events.



To watch this video, go to the web version of this document.

www.axis.com/products/online-manual/22816#t10130736

1. In AXIS Companion, go to  > Cameras.
2. Make sure the camera is enabled in the **Motion detection** column.
3. Click  for a camera and select **Motion recording...**
4. In the **Motion recording** dialog, click **Settings...**
5. Choose what part of the camera view to include in the motion detection:
 - Edit the dark area to be included for motion detection.
 - To draw an area that will be excluded from motion detection, select **Exclude area** and edit the light area.

Note

For some camera models you can only draw squares, and for others you can draw more complex polygons.

AXIS Companion Dome WV

Daily use

6. Expand **Advanced** to adjust the settings of the filters.
 - **Small objects filter** – Ignore objects that are small, such as animals.
 - **Swaying objects filter** – Ignore objects that only move within a short distance, such as trees or flags that move when it is windy.

Note

The swaying objects filter is not available for all camera models.

- **Short-lived objects filter** – Ignore objects that only appear for a short period of time, such as light beams from passing cars or fast-moving shadows.
7. Click **OK** twice.

Set up notifications

You can make AXIS Companion send a notification to your mobile app when certain types of motion occur in a camera view.

The motion triggers are based on the following ACAPs:

- AXIS Video Motion Detection
- AXIS Fence Guard

Workflow:

1. Make sure the ACAP is activated in your device.
2. In AXIS Companion, go to  > **Events** and select an ACAP.
3. Configure a schedule for when you want to receive notifications.
4. Under **Activation**, select the cameras you want notifications from.

Receiving notifications on your mobile device:

- Push notifications are sent to your mobile app if you are logged in to your MyAxis account on your mobile.
- When you install the AXIS Companion 4 mobile app, you must accept when prompted with a question if you want to receive notifications. If you want to deactivate the notifications later on, go to the settings of your mobile device, select the AXIS Companion 4 app, and disable the notifications.

To turn notifications on or off in the mobile app:

1. Go to  > **Notifications**.
2. Turn **Motion detection** on or off.

When a notification is sent, it will appear as a popup message on your mobile device. Tap the message to open the playback of the ongoing event.

AXIS Companion Dome WV

Daily use

Add a user









To watch this video, go to the web version of this document.

www.axis.com/products/online-manual/22816#t10133929

1. Go to  > Users.
2. Click Add...
3. Enter an email address and select an access level, then click OK.

The following access levels are available:

Administrator	   Full access
Operator	  Can access recordings and live view, but can't make any changes to the site
Viewer	 Can only access live view

Activate offline mode

If you are running AXIS Companion while there is no connection to the internet, then you can enter offline mode. This makes Live view and Recordings available locally. However, you will not be able to access the Configuration menu while the internet connection is down.

Activate offline mode:

- Click  > Site and turn on Offline mode.

Note

You can only use live view and playback while in offline mode. All other operations require connection to the internet.

The PC that access the site in offline mode should be connected to the same subnet as the cameras. You can't use offline mode if any of the networks the PC is connected to have access to the internet.

To be able to access the site without internet connection, you need to activate offline mode in advance while the site is online.

For sites that will be used mostly offline, we recommend you to set them up with static IP or DHCP reservation.

Notifications will not be sent during offline mode.

AXIS Companion Dome WV

Daily use

Show video on an external display



To watch this video, go to the web version of this document.

www.axis.com/products/online-manual/22816#t10134228

What you need:

- An Apple TV or Android TV device.
- The AXIS Companion 4 app installed on your mobile device.
- The AXIS Companion TV app installed from the app store on your Apple TV or Android TV device.
- Your cameras, mobile app and TV app must all be connected to the same local network.
- AppleTV 4 and Nvidia Shield with Android 6 or later.

This is how you do it:

1. Open the AXIS Companion 4 mobile app and log in.
2. Go to Devices >  and select your external display.

Note

It may take a few seconds before the icon appears.

3. Select the cameras you want to show on your external display.
4. Tap  and wait for the configuration to complete.
5. You can view a single camera at a time or create a split view with up to 16 cameras.
6. When the AXIS Companion 4 TV app opens, read the instructions on the screen about how to navigate in the app.



Monitor a narrow space

Use corridor format to better utilize the full field of view in a long and narrow space, for example a staircase, hallway, road, or tunnel.

AXIS Companion Dome WV

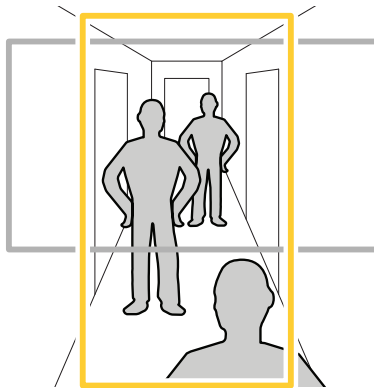
Daily use



1. Adjust the camera or its lens to a vertical field of view.
2. In AXIS Companion, go to  > **Cameras**.
3. On the row of the camera you want to adjust, click  > **Image settings**.
4. On the **Appearance** tab, select a suitable angle for **Orientation**.
5. Click **Close**.

Connect to a door station

You can connect a door station to both your AXIS Companion desktop app as well as the mobile app. This makes it possible for you to answer calls, unlock a door and view a door station video with your mobile device.

Note

To unlock a door, your door station must be properly connected to the door's electronic lock. The documentation for your door station contains information about how to make this connection correctly. To find the documentation for your door station, go to axis.com/products/access-control/network-door-stations

Note

Make sure the door station is connected to the same network as your computer, otherwise it won't show up in the list of devices in your AXIS Companion apps.

Connect your desktop app to a door station

1. In the AXIS Companion desktop app, go to  > **Cameras**.
2. Click **Add devices** and add the door station.

You can now answer the door station with your AXIS Companion desktop app.

Connect your mobile app to a door station

1. *Connect your desktop app to a door station on page 17.*
2. Start the AXIS Companion 4 mobile app.
3. Log in to the same MyAxis account as you used for the desktop app.

AXIS Companion Dome WV

Daily use

You can now answer the door station with your AXIS Companion 4 mobile app.

Give other users access to the door station:

1. From the AXIS Companion desktop app, go to  > **Users**.
2. Invite the user to the site.

Turn off calls from the door station:

1. In the AXIS Companion 4 mobile app, go to **User**.
2. Go to **Notifications** and turn off **Door station calls**.

Add cameras to your site

1. Connect the cameras to the recorders integrated PoE switch or an external PoE switch.
2. Go to  > **Cameras**.
3. Click **Add devices**.
4. Select the devices you want to add to your site.

If any devices are password-protected, then you must enter the password for them before they can be selected.

Note



If you have devices that are not supported, then you can click **Read more** to find out why they are not supported.

5. Click **Next**.
6. Enter a password.
This password is used for accessing the device webpages or offline mode in the AXIS Companion mobile app.
7. Click **Next**.
8. On the **Ready to install** page, there might be a list of cameras that need to be restored. If so, click the **Restore device** link to fix the issue on the device webpage.
9. Click **Finish** and wait while AXIS Companion configures the cameras.

Note

The configuration may take several minutes.

Remove a camera from your site

1. Go to  > **Cameras**.
2. On the row of the camera you want to remove, click  > **Remove**.
3. If the camera has ongoing recordings, select **Stop motion and continuous recording** to stop recordings.
4. Click **OK**.

AXIS Companion Dome WV

Troubleshooting

Troubleshooting

LED indicators

Status LED	Indication
Unlit	Connection and normal operation.
Green	Shows steady green for 10 seconds for normal operation after startup completed. Flashes green during wireless network pairing.
Amber	Steady during startup. Flashes during firmware upgrade or reset to factory default.
Amber/Red	Flashes amber/red if network connection is unavailable or lost.
Red	Firmware upgrade failure.

SD card slot

For SD card recommendations, see axiscompanion.com.

Buttons

Control button

The control button is used for:

- Resetting the product to factory default settings. See *Hard reset a camera on page 20* or *Hard reset a recorder on page 21*

Technical issues, clues and solutions

Issue	Solution
I have no live view.	Go to <i>Fix common issues on page 19</i> .
My recordings are not available.	Go to <i>Fix common issues on page 19</i> .
I cannot connect to my cameras.	Go to <i>Fix common issues on page 19</i> .
I receive error notification: "No contact".	Go to <i>Fix common issues on page 19</i> .
My sites do not appear in my mobile app.	Make sure you have version 4 of the AXIS Companion mobile app.
My video stream is lagging.	Make sure that your graphics card is updated with the latest drivers.

Fix common issues

Before you restart, configure or reset your devices, we recommend that you to save a system report.

See *Save a system report on page 21*.

1. Check that your cameras and recorder have power.
2. Check that you are connected to the internet.

AXIS Companion Dome WV

Troubleshooting

3. Check that the network is working.
4. Check that the cameras are connected to the same network as the computer, unless you are remote.

Still not working?

5. Make sure that your cameras, recorder and AXIS Companion desktop app have the latest firmware and software updates.
See [Upgrade firmware on page 20](#).
6. Restart the AXIS Companion desktop app.
7. Restart you cameras and recorder.

Still not working?

8. Make a hard reset on the cameras and the recorder, to completely put them back to factory default settings.
See [Hard reset a camera on page 20](#) and [Hard reset a recorder on page 21](#).
9. Add the reset cameras to your site again.

Still not working?

10. Update your graphics card with the latest drivers.

Still not working?

11. Save a system report and contact *Axis technical support*.
See [Save a system report on page 21](#).

Upgrade firmware

New firmware updates bring you to the latest and improved set of features, functions, and security enhancements.

1. Go to the leader device webpage.
2. Go to **System > Maintenance** and click **Upgrade** under **Firmware upgrade**.
3. Follow the instructions on the screen.

Hard reset a camera

Note

A hard reset will not affect your recordings.

Note

A hard reset will reset all the settings, including the IP address.

1. Select the camera you want to hard reset and remove it from the site.
See [Remove a camera from your site on page 18](#).
2. Disconnect the power from the device.
3. Press and hold the control button on the device, and then reconnect the power.
Keep the control button pressed for 15–30 seconds until the status LED indicator flashes amber.
4. Release the control button.

AXIS Companion Dome WV

Troubleshooting

The process is complete when the status LED indicator turns green.

The product has now been reset to the factory default settings.

5. Add the camera to the site again, see *Add cameras to your site on page 18*.

Hard reset a recorder

⚠WARNING

Move the recorder very gently while it is switched on. Sudden moves or shocks may damage the hard drive.

⚠WARNING

A hard reset will remove the saved encryption password for the hard drive. Failure to remember the encryption password for an encrypted hard drive will result in permanent loss of all recordings.

Note

A hard reset will reset all the settings, including the IP address.

1. Switch off the recorder:
Press the power button on the front of the recorder for 4-5 seconds until you hear a beep.
2. Wait until the recorder is switched off, then turn it over to access the control button.
3. Press and hold the control button. Press and release the power button to start the recorder. Release the control button after 15-30 seconds when the LED indicator flashes amber.
4. Slowly put the recorder back in its place.
5. The process is complete when the status LED indicator turns green. The product has been reset to the factory default settings. If no DHCP server is available on the network, the default IP address is 192.168.0.90
6. Reset your cameras connected to the recorder. See *Hard reset a camera on page 20*.
7. If your hard drive is encrypted, then it must be mounted manually after the recorder is reset:
 - 7.1 Go to the device webpage.
 - 7.2 Go to **System > Storage** and click **Mount**.
 - 7.3 Enter the encryption password used when encrypting the hard drive.

Save a system report



1. In AXIS Companion, go to  > **Save system report**.
2. When you register a new case at Axis Helpdesk, attach the system report.

