

AXIS M11-E Mk II Series

AXIS M1135-E Mk II Box Camera

AXIS M1137-E Mk II Box Camera

AXIS M11-E Mk II Series

Table of Contents

About this manual	3
Installation	4
Get started	5
Find the device on the network	5
Open the device's webpage	5
Webpage overview	6
Configure your device	7
Replace the lens	7
Adjust the image	7
View and record video	11
Set up rules for events	13
The device interface	16
Status	16
Video	17
Audio	27
Recordings	28
Apps	28
System	29
Maintenance	43
Learn more	45
Bitrate control	45
View area	46
Privacy masks	46
Overlays	47
Streaming and storage	47
Applications	47
Specifications	49
Product overview	49
LED indicators	50
SD card slot	51
Buttons	51
Connectors	51
Troubleshooting	53
Reset to factory default settings	53
Firmware options	53
Check the current firmware version	53
Upgrade the firmware	53
Technical issues, clues, and solutions	54
Performance considerations	55
Need more help?	56

AXIS M11-E Mk II Series

About this manual

About this manual

This user manual describes several products. This means you may find instructions that aren't applicable to your product.

AXIS M11-E Mk II Series

Installation

Installation



To watch this video, go to the web version of this document.

www.axis.com/products/online-manual/#t10169339

Installation video for the product.

AXIS M11-E Mk II Series

Get started

Get started

Find the device on the network

To find Axis devices on the network and assign them IP addresses in Windows®, use AXIS IP Utility or AXIS Device Manager. Both applications are free and can be downloaded from axis.com/support.

For more information about how to find and assign IP addresses, go to *How to assign an IP address and access your device*.

Browser support

You can use the device with the following browsers:

	Chrome™	Firefox®	Edge™	Safari®
Windows®	recommended	recommended	✓	
macOS®	recommended	recommended	✓	✓
Linux®	recommended	recommended	✓	
Other operating systems	✓	✓	✓	✓*

*To use AXIS OS web interface with iOS 15 or iPadOS 15, go to **Settings > Safari > Advanced > Experimental Features** and disable *NSURLSession Websocket*.

If you need more information about recommended browsers, go to *AXIS OS Portal*.

Open the device's webpage

1. Open a browser and enter the IP address or host name of the Axis device.
If you do not know the IP address, use AXIS IP Utility or AXIS Device Manager to find the device on the network.
2. Enter the username and password. If you access the device for the first time, you must set the root password. See *Set a new password for the root account on page 5*.

Verify that no one has tampered with the firmware

To make sure that the device has its original Axis firmware, or to take full control of the device after a security attack:

1. Reset to factory default settings. See *Reset to factory default settings on page 53*.
After the reset, secure boot guarantees the state of the device.
2. Configure and install the device.

Set a new password for the root account

The default administrator username is root. There's no default password for the root account. You set a password the first time you log in to the device.

1. Type a password. Follow the instructions about secure passwords. See *Secure passwords on page 6*.
2. Retype the password to confirm the spelling.
3. Click **Add user**.

Important

If you lose the password for the root account, go to *Reset to factory default settings on page 53* and follow the instructions.

AXIS M11-E Mk II Series

Get started

Secure passwords

Important

Axis devices send the initially set password in clear text over the network. To protect your device after the first login, set up a secure and encrypted HTTPS connection and then change the password.

The device password is the primary protection for your data and services. Axis devices do not impose a password policy as they may be used in various types of installations.

To protect your data we strongly recommend that you:

- Use a password with at least 8 characters, preferably created by a password generator.
- Don't expose the password.
- Change the password at a recurring interval, at least once a year.

Webpage overview

This video gives you an overview of the device interface.



To watch this video, go to the web version of this document.

www.axis.com/products/online-manual/#t10157625

Axis device web interface

AXIS M11-E Mk II Series

Configure your device

Configure your device

Replace the lens



1. Stop all recordings and disconnect power from the product.
2. Disconnect the lens cable and remove the standard lens.
3. Attach the new lens and connect the lens cable.
4. Reconnect the power.
5. For the changes to take effect, you need to restart the device. Go to **System > Maintenance** and click **Restart**.
6. Adjust the zoom and focus.

Adjust the image

This section includes instructions about configuring your device. If you want to learn more about how certain features work, go to *Learn more on page 45*.

Level the camera

To adjust the view in relation to a reference area or an object, use the level grid in combination with a mechanical adjustment of the camera.

1. Go to **Video > Image >** and click  .
2. Click  to show the level grid.
3. Adjust the camera mechanically until the position of the reference area or the object is aligned with the level grid.

Select exposure mode

To improve image quality for specific surveillance scenes, use exposure modes. Exposure modes lets you control aperture, shutter speed, and gain. Go to **Video > Image > Exposure** and select between the following exposure modes:

- For most use cases, select **Automatic** exposure.
- For environments with certain artificial lighting, for example fluorescent lighting, select **Flicker-free**.
Select the same frequency as the power line frequency.
- For environments with certain artificial light and bright light, for example outdoors with fluorescent lighting at night and sun during daytime, select **Flicker-reduced**.
Select the same frequency as the power line frequency.
- To lock the current exposure settings, select **Hold current**.

Benefit from IR light in low-light conditions by using night mode

Your camera uses visible light to deliver color images during the day. But as the visible light diminishes, color images become less bright and clear. If you switch to night mode when this happens, the camera uses both visible and near-infrared light to deliver bright and detailed black-and-white images instead. You can set the camera to switch to night mode automatically.

1. Go to **Video > Image > Day-night mode**, and make sure that the **IR-cut filter** is set to **Auto**.

AXIS M11-E Mk II Series

Configure your device

2. To set at what light level you want the camera to switch to night mode, move the Threshold slider toward **Bright** or **Dark**.

Note

If you set the switch to night mode to occur when it's brighter, the image remains sharper as there is less low-light noise. If you set the switch to occur when it's darker, the image colors are maintained for longer, but there is more image blur due to low-light noise.

Reduce noise in low-light conditions

To reduce noise in low-light conditions, you can adjust one or more of the following settings:

- Adjust the trade-off between noise and motion blur. Go to **Video > Image > Exposure** and move the **Blur-noise trade-off** slider toward **Low noise**.
- Set the exposure mode to automatic.

Note

A high max shutter value can result in motion blur.

- To slow down the shutter speed, set max shutter to the highest possible value.

Note

When you reduce the max gain, the image can become darker.

- Set the max gain to a lower value.
- Open the aperture.

Reduce motion blur in low-light conditions

To reduce motion blur in low-light conditions, adjust one or more of the following settings in **Video > Image > Exposure**:

- Move the **Blur-noise trade-off** slider toward **Low motion blur**.

Note

When you increase the gain, image noise also increases.

- Set **Max shutter** to a shorter time, and **Max gain** to a higher value.

If you still have problems with motion blur:

- Increase the light level in the scene.
- Mount the camera so that objects move toward it or away from it rather than sideways.

Handle scenes with strong backlight

Dynamic range is the difference in light levels in an image. In some cases the difference between the darkest and the brightest areas can be significant. The result is often an image where either the dark or the bright areas are visible. Wide dynamic range (WDR) makes both dark and bright areas of the image visible.

AXIS M11-E Mk II Series

Configure your device



Image without WDR.



Image with WDR.

Note

- WDR can cause artifacts in the image.
 - WDR may not be available for all capture modes.
1. Go to **Video > Image > Wide dynamic range**.
 2. Turn on WDR.
 3. Use the **Tone mapping** slider to adjust the amount of WDR.
 4. If you still have problems, go to **Exposure** and adjust the **Exposure zone** to cover the area of interest.

Find out more about WDR and how to use it at axis.com/web-articles/wdr.



Verify the pixel resolution

To verify that a defined part of the image contains enough pixels to, for example, recognize license plates, you can use the pixel counter.

AXIS M11-E Mk II Series

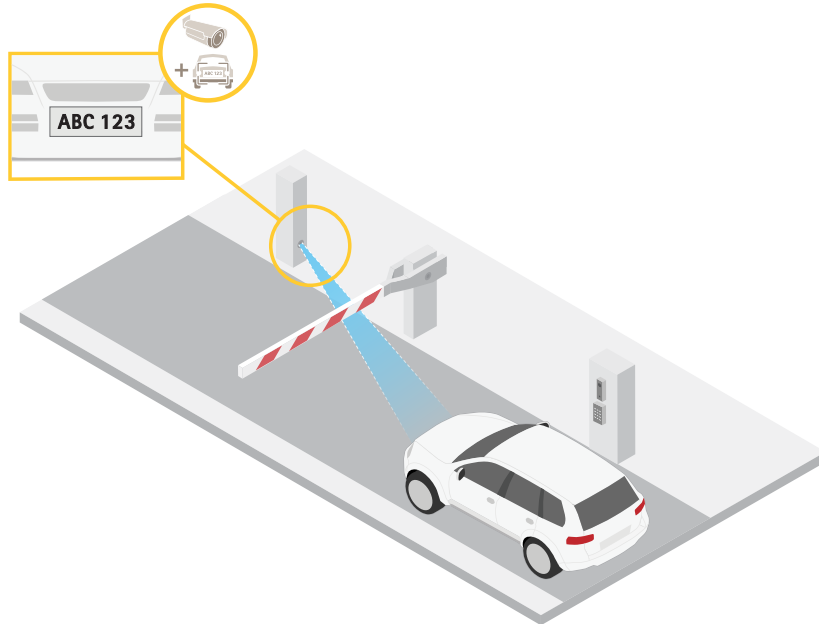
Configure your device



1. Go to **Video > Image** and click .
2. Click  for Pixel counter.
3. In the camera's live view, adjust the size and position of the rectangle around the area of interest, for example where you expect license plates to appear.

You can see the number of pixels for each of the rectangle's sides, and decide if the values are enough for your needs.

Hide parts of the image with privacy masks

You can create one or several privacy masks to hide parts of the image.

1. Go to **Video > Privacy masks**.
2. Click .
3. Click the new mask and type a name.
4. Adjust the size and placement of the privacy mask according to your needs.
5. To change the color for all privacy masks, expand **Privacy masks** and select a color.

See also *Privacy masks on page 27*

Show an image overlay

You can add an image as an overlay in the video stream.

1. Go to **Video > Overlays**.

AXIS M11-E Mk II Series

Configure your device



2. Select **Image** and click  .
3. Go to the **Images** tab.
4. Drag and drop an image.
5. Click **Upload**.
6. Go to the **Manage overlay** tab.
7. Select the image and a position. You can also drag the overlay image in the live view to change the position.

Show a text overlay in the video stream when the device detects an object

This example explains how to display the text "Motion detected" when the device detects an object.

1. Start the application if it is not already running.
2. Make sure you have set up the application according to your needs.

Add the overlay text:

1. Go to **Video > Overlays**.
2. Under **Overlays**, select **Text** and click  .
3. Enter #D in the text field.
4. Choose text size and appearance.
5. To position the text overlay, click  and select an option.

Create a rule:

1. Go to **System > Events** and add a rule.
2. Type a name for the rule.
3. In the list of actions, under **Overlay text**, select **Use overlay text**.
4. Select a video channel.
5. In **Text**, type "Motion detected".
6. Set the duration.
7. Click **Save**.

Note

If you update the overlay text it will be automatically updated on all video streams dynamically.

View and record video

This section includes instructions about configuring your device. To learn more about how streaming and storage works, go to *Streaming and storage on page 47*.

AXIS M11-E Mk II Series

Configure your device

Reduce bandwidth and storage

Important

Reducing the bandwidth can result in loss of details in the image.

1. Go to **Video > Stream**.
2. Click  in the live view.
3. Select **Video format H.264**.
4. Go to **Video > Stream > General** and increase **Compression**.
5. Go to **Video > Stream > H.264 and H.265 encoding** and do one or more of the following:
 - Select the **Zipstream** level that you want to use.

Note

The **Zipstream** settings are used for both H.264 and H.265.

- Turn on **Dynamic FPS**.
- Turn on **Dynamic GOP** and set a high **Upper limit GOP length** value.

Note

Most web browsers don't support H.265 decoding and because of this the camera doesn't support it in its web interface. Instead you can use a video management system or application that supports H.265 decoding.

Set up network storage

To store recordings on the network, you need to set up your network storage.

1. Go to **System > Storage**.
2. Click  **Add network storage** under **Network storage**.
3. Type the IP address of the host server.
4. Type the name of the shared location on the host server under **Network share**.
5. Type the username and password.
6. Select the SMB version or leave it on **Auto**.
7. Select **Add share even if connection fails** if you experience temporary connection issues, or if the share is not yet configured.
8. Click **Add**.



Record and watch video

Record video directly from the camera

1. Go to **Video > Image**.
2. To start a recording, click  .

AXIS M11-E Mk II Series

Configure your device

If you haven't set up any storage, click  and . For instructions on how to set up network storage, see *Set up network storage on page 12*

3. To stop recording, click  again.

Watch video

1. Go to Recordings.
2. Click  for your recording in the list.

Set up rules for events

You can create rules to make your device perform an action when certain events occur. A rule consists of conditions and actions. The conditions can be used to trigger the actions. For example, the device can start a recording or send an email when it detects motion, or show an overlay text while the device is recording.

To learn more, check out our guide *Get started with rules for events*.

Trigger an action

1. Go to **System > Events** and add a rule. The rule defines when the device will perform certain actions. You can set up rules as scheduled, recurring, or manually triggered.
2. Enter a **Name**.
3. Select the **Condition** that must be met to trigger the action. If you specify more than one condition for the rule, all of the conditions must be met to trigger the action.
4. Select which **Action** the device should perform when the conditions are met.

Note

If you make changes to an active rule, the rule must be turned on again for the changes to take effect.

Record video when the camera detects an object

This example explains how to set up the camera to start recording to the SD card five seconds before it detects an object and to stop one minute after.

1. Start the application if it is not already running.
2. Make sure you have set up the application according to your needs.

Create a rule:

1. Go to **System > Events** and add a rule.
2. Type a name for the rule.
3. In the list of actions, under **Recordings**, select **Record video while the rule is active**.
4. In the list of storage options, select **SD_DISK**.
5. Select a camera and a stream profile.
6. Set the prebuffer time to 5 seconds.
7. Set the postbuffer time to 1 minute.
8. Click **Save**.

AXIS M11-E Mk II Series

Configure your device

Record video when a PIR detector senses motion

This example explains how to connect an Axis PIR detector to the camera, and set up the camera to start recording when the detector senses motion.

Required hardware

- 3-wire cable (ground, power, I/O)
- Axis PIR detector

NOTICE

Disconnect the camera from power before connecting the wires. Reconnect to power after all connections are done.

Connect the wires to the camera's I/O connector

Note

For information on the I/O connector, see *Connectors on page 51*.

1. Connect the ground wire to pin 1 (GND/-).
2. Connect the power wire to pin 2 (12V DC output).
3. Connect the I/O wire to pin 3 (I/O input).

Connect the wires to the PIR detector's I/O connector

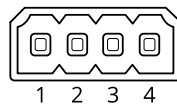

1. Connect the other end of the ground wire to pin 1 (GND/-).
2. Connect the other end of the power wire to pin 2 (DC input/+).
3. Connect the other end of the I/O wire to pin 3 (I/O output).

Configure the I/O port in the camera's webpage

1. Go to **System > Accessories**.
2. Give the input module a descriptive name.
3. Under **Normal position**, select **Circuit closed** to make the PIR detector send a signal to the camera when it senses motion.

To trigger the camera to start recording when it receives a signal from the PIR detector, you need to create a rule in the camera's webpage.

Send an email automatically if someone spray paints the lens

Activate the tampering detection:

1. Go to **System > Detectors > Camera tampering**.
2. Set a duration for **Trigger after**. The value indicates the time that must pass before an email is sent.
3. Turn on **Trigger on dark images** to detect if the lens is sprayed, covered, or rendered severely out of focus.

Add an email recipient:

4. Go to **System > Events > Recipients** and add a recipient.

AXIS M11-E Mk II Series

Configure your device

5. Type a name for the recipient.
6. Select **Email**.
7. Type an email address to send the email to.
8. The camera doesn't have its own email server, so it has to log into another email server to send mails. Fill in the rest of the information according to your email provider.
9. To send a test email, click **Test**.
10. Click **Save**.

Create a rule:

11. Go to **System > Events > Rules** and add a rule.
12. Type a name for the rule.
13. In the list of conditions, under **Video**, select **Tampering**.
14. In the list of actions, under **Notifications**, select **Send notification to email** and then select the recipient from the list.
15. Type a subject and a message for the email.
16. Click **Save**.

AXIS M11-E Mk II Series









The device interface

The device interface

You reach the device interface by entering the IP address of the device in a web browser.

Note

Support for the features and settings described in this section varies between devices.

	Show or hide the main menu.
	Access the product help.
	Change the language.
	Set light theme or dark theme.
  	See information about the user who is logged in.
	The context menu contains: <ul style="list-style-type: none">• Analytics data: Accept to share non-personal browser data.• Feedback: Share any feedback to help us improve your user experience.• Legal: View information about cookies and licenses.• About: View device information, including firmware version and serial number.• Legacy device interface: Change the device interface to the legacy device interface.

Status

NTP sync

Shows NTP synchronization information, including if the device is in sync with an NTP server and the time remaining until the next sync.

NTP settings: Click to go to the Date and time page where you can change the NTP settings.

Device info

Shows device information, including firmware version and serial number.

Upgrade firmware: Click to go to the Maintenance page where you can do a firmware upgrade.

AXIS M11-E Mk II Series

The device interface

Video



Click to play the live video stream.



Click to freeze the live video stream.



Click to take a snapshot of the live video stream. The file is saved in the 'Downloads' folder on your computer. The image file name is [snapshot_YYYY_MM_DD_HH_MM_SS.jpg]. The size of the snapshot depends on the compression that is applied from the specific web-browser engine where the snapshot is received, therefore, the snapshot size may vary from the actual compression setting that is configured in the device.



Click to show I/O output ports. Use the switch to open or close the circuit of a port, for example to test external devices.



Click to manually turn on or turn off the IR illumination.



Click to access onscreen controls:

- **Predefined controls:** Turn on to use the available onscreen controls.



- **Custom controls:** Click  Add custom control to add an onscreen control.



Click to manually turn on the heater for a selected period of time.





Click to start a continuous recording of the live video stream. Click again to stop the recording. If a recording is ongoing, it will resume automatically after a reboot.



Click to show the storage that is configured for the device. To configure the storage you need to be logged in as an administrator.





Click to access more settings:

- **Video format:** Select the encoding format to use in the live view. If you select a format with video compression, it results in a higher CPU and memory usage.
- **Client stream information:** Turn on to show dynamic information about the video stream used by the browser that shows the live video stream. The bitrate information differs from the information shown in a text overlay, because of different information sources. The bitrate in the client stream information is the bitrate of the last second, and it comes from the encoding driver of the device. The bitrate in the overlay is the average bitrate of the last 5 seconds, and it comes from the browser. Both values cover only the raw video stream and not the additional bandwidth generated when it's transported over the network through UDP/TCP/HTTP.
- **Adaptive stream:** Turn on to adapt the image resolution to the viewing client's actual display resolution, to increase the user experience and help prevent a possible overload of the client's hardware. The adaptive stream is only applied when you view the live video stream in the web interface in a browser. When adaptive stream is turned on, the maximum frame rate is 30 fps. If you take a snapshot while adaptive stream is turned on, it will use the image resolution selected by the adaptive stream.
- **Level grid:** Click  to show the level grid. The grid helps you decide if the image is horizontally aligned. Click  to hide it.
- **Pixel counter:** Click  to show the pixel counter. Drag and resize the box to contain your area of interest. You can also define the pixel size of the box in the **Width** and **Height** fields.

AXIS M11-E Mk II Series

The device interface

- Refresh: Click  to refresh the still image in the live view.
- 1:1** Click to show the live view at full resolution. If the full resolution is larger than your screen size, use the smaller image to navigate in the image.
-  Click to show the live video stream in full screen. Press ESC to exit full screen mode.

Installation

Capture mode  : A capture mode is a preset configuration that defines how the camera captures images. When you change the capture mode, it can affect many other settings, such as view areas and privacy masks.

Mounting position  : The orientation of the image can change depending on how the camera is mounted.



Power line frequency: Select the frequency that is used in your region to minimize image flicker. The American regions usually use 60 Hz. The rest of the world mostly uses 50 Hz. If you're not sure of your region's power line frequency, check with the local authorities.

Rotate: Select the preferred image orientation.

Image

Appearance

Scene profile  : Select a scene profile that suits your surveillance scenario. A scene profile optimizes image settings, including color level, brightness, sharpness, contrast, and local contrast, for a specific environment or purpose.

- Forensic: Suitable for surveillance purposes.
- Indoor  : Suitable for indoor environments.
- Outdoor  : Suitable for outdoor environments.
- Vivid: Useful for demonstration purposes.
- Traffic overview: Suitable for vehicle traffic monitoring.

Saturation: Use the slider to adjust the color intensity. You can for example get a grayscale image.



Contrast: Use the slider to adjust the difference between light and dark.

AXIS M11-E Mk II Series

The device interface



Brightness: Use the slider to adjust the light intensity. This can make objects easier to see. Brightness is applied after image capture, and doesn't affect the information in the image. To get more details from a dark area, it's usually better to increase gain or exposure time.



Sharpness: Use the slider to make objects in the image appear sharper by adjusting the edge contrast. If you increase the sharpness, it may increase the bitrate and the amount of storage space needed as well.



Wide dynamic range

WDR: Turn on to make both bright and dark areas of the image visible.

Local contrast ⓘ : Use the slider to adjust the contrast of the image. A higher value makes the contrast higher between dark and light areas.

Tone mapping ⓘ : Use the slider to adjust the amount of tone mapping that is applied to the image. If the value is set to zero only the standard gamma correction is applied, while a higher value increases the visibility in the image.

White balance

AXIS M11-E Mk II Series

The device interface

When the camera detects the color temperature of the incoming light, it can adjust the image to make the colors look more natural. If this is not sufficient, you can select a suitable light source from the list.

The automatic white balance setting reduces the risk of color flicker by adapting to changes gradually. If the lighting changes, or when the camera is first started, it can take up to 30 seconds to adapt to the new light source. If there is more than one type of light source in a scene, that is they differ in color temperature, the dominating light source acts as a reference for the automatic white balance algorithm. This behavior can be overridden by choosing a fixed white balance setting that matches the light source you want to use as a reference.

Light environment:

- **Automatic:** Automatic identification and compensation for the light source color. This is the recommended setting which can be used in most situations.
- **Automatic – outdoors** ⓘ : Automatic identification and compensation for the light source color. This is the recommended setting which can be used in most outdoor situations.
- **Custom – indoors** ⓘ : Fixed color adjustment for a room with some artificial light other than fluorescent lighting and good for a normal color temperature around 2800 K.
- **Custom – outdoors** ⓘ : Fixed color adjustment for sunny weather conditions with a color temperature around 5500 K.
- **Fixed – fluorescent 1:** Fixed color adjustment for fluorescent lighting with a color temperature around 4000 K.
- **Fixed – fluorescent 2:** Fixed color adjustment for fluorescent lighting with a color temperature around 3000 K.
- **Fixed – indoors:** Fixed color adjustment for a room with some artificial light other than fluorescent lighting and good for a normal color temperature around 2800 K.
- **Fixed – outdoors 1:** Fixed color adjustment for sunny weather conditions with a color temperature around 5500 K.
- **Fixed – outdoors 2:** Fixed color adjustment for cloudy weather condition with a color temperature around 6500 K.
- **Street light – mercury** ⓘ : Fixed color adjustment for ultraviolet emission in mercury vapor lights common in street lighting.
- **Street light – sodium** ⓘ : Fixed color adjustment that compensates for the yellow orange color of sodium vapor lights common in street lighting.
- **Hold current:** Keep the current settings and do not compensate for light changes.
- **Manual** ⓘ : Fix the white balance with the help of a white object. Drag the circle to an object that you want the camera to interpret as white in the live view image. Use the **Red balance** and **Blue balance** sliders to adjust the white balance manually.

Day-night mode

IR-cut filter:

- **Auto:** Select to automatically turn on and off the IR-cut filter. When the camera is in day mode, the IR-cut filter is turned on and blocks incoming infrared light, and when in night mode, the IR-cut filter is turned off and the camera's light sensitivity increases.
- **On:** Select to turn on the IR-cut filter. The image is in color, but with reduced light sensitivity.
- **Off:** Select to turn off the IR-cut filter. The image is in black and white for increased light sensitivity.

Threshold: Use the slider to adjust the light threshold where the camera changes from day mode to night mode.

- Move the slider towards **Bright** to decrease the threshold for the IR-cut filter. The camera changes to night mode earlier.
- Move the slider towards **Dark** to increase the threshold for the IR-cut filter. The camera changes to night mode later.

IR light

 ⓘ

If your device doesn't have built-in illumination, these controls are only available when you have connected a supporting Axis accessory.

Allow illumination: Turn on to let the camera use the built-in light in night mode.

AXIS M11-E Mk II Series

The device interface

Synchronize illumination: Turn on to automatically synchronize the illumination with the surrounding light. The synchronization between day and night only works if the IR-cut filter is set to **Auto** or **Off**.

Automatic illumination angle ⓘ : Turn on to use the automatic illumination angle.

Illumination angle ⓘ : Use the slider to manually set the illumination angle, for example if the angle needs to be different from the camera's angle of view. If the camera has a wide angle of view, you can set the illumination angle to a narrower angle, which equals a greater tele position. This will result in dark corners in the image.

IR wavelength ⓘ : Select the desired wavelength for the IR light.

White light ⓘ

Allow illumination ⓘ : Turn on to let the camera use white light in night mode.

Synchronize illumination ⓘ : Turn on to automatically synchronize the white light with the surrounding light.

Exposure

Exposure mode: Select an exposure mode to reduce rapidly changing irregular effects in the image, for example flicker produced by different types of light sources. We recommend you to use the automatic exposure mode, or the same frequency as your power network.

- **Automatic:** The camera adjusts the aperture, gain and shutter automatically.
- **Automatic aperture** ⓘ : The camera adjusts the aperture and gain automatically. The shutter is fixed.
- **Automatic shutter** ⓘ : The camera adjusts the shutter and gain automatically. The aperture is fixed.
- **Hold current:** Locks the current exposure settings.
- **Flicker-free** ⓘ : The camera adjusts the aperture and gain automatically, and uses only the following shutter speeds: 1/50 s (50 Hz) and 1/60 s (60 Hz).
- **Flicker-free 50 Hz** ⓘ : The camera adjusts the aperture and gain automatically, and uses the shutter speed 1/50 s.
- **Flicker-free 60 Hz** ⓘ : The camera adjusts the aperture and gain automatically, and uses the shutter speed 1/60 s.
- **Flicker-reduced** ⓘ : This is the same as flicker-free, but the camera might use shutter speeds faster than 1/100 s (50 Hz) and 1/120 s (60 Hz) for brighter scenes.
- **Flicker-reduced 50 Hz** ⓘ : This is the same as flicker-free, but the camera might use shutter speeds faster than 1/100 s for brighter scenes.
- **Flicker-reduced 60 Hz** ⓘ : This is the same as flicker-free, but the camera might use shutter speeds faster than 1/120 s for brighter scenes.
- **Manual** ⓘ : The aperture, gain and shutter are fixed.





Exposure zone: The exposure zone tells the camera to prioritize image quality in the most important part of the scene. Select the part of the scene of greatest interest to calculate the automatic exposure levels, for example the area in front of an entrance door.

AXIS M11-E Mk II Series

The device interface

Note

The exposure zones are related to the original image (un-rotated), and the names of the zones apply to the original image. This means, for example, that if the video stream is rotated 90°, then the **Upper** zone becomes the **Right** zone in the stream, and **Left** becomes **Lower**.

- **Automatic:** Suitable for most situations.
- **Center:** Uses a fixed area in the center of the image to calculate the exposure. The area has a fixed size and position in the live view.
- **Full**  : Uses the entire live view to calculate the exposure.
- **Upper**  : Uses an area with a fixed size and position in the upper part of the image to calculate the exposure.
- **Lower**  : Uses an area with a fixed size and position in the lower part of the image to calculate the exposure.
- **Left**  : Uses an area with a fixed size and position in the left part of the image to calculate the exposure.
- **Right**  : Uses an area with a fixed size and position in the right part of the image to calculate the exposure.
- **Spot:** Uses an area with a fixed size and position in the live view to calculate the exposure.
- **Custom:** Uses an area in the live view to calculate the exposure. You can adjust the size and position of the area.

Max shutter: Select the shutter speed to provide the best image. Low shutter speeds (longer exposure) might cause motion blur when there is movement, and a too high shutter speed might affect the image quality. Max shutter works with max gain to improve the image.

Max gain: Select the suitable max gain. If you increase the max gain, it improves the visible level of detail in dark images, but also increases the noise level. More noise can also result in increased use of bandwidth and storage. If you set the max gain to a high value, images can differ a lot if the light conditions are very different from day to night. Max gain works with max shutter to improve the image.

Motion-adaptive exposure  : Select to reduce motion blur in low-light conditions.

Blur-noise trade-off: Use the slider to adjust the priority between motion blur and noise. If you want to prioritize low bandwidth and have less noise at the expense of details in moving objects, move the slider towards **Low noise**. If you want to prioritize the preservation of details in moving objects at the expense of noise and bandwidth, move the slider towards **Low motion blur**.

Note

You can change the exposure either by adjusting the exposure or by adjusting the gain. If you increase the exposure time, it results in more motion blur, and if you increase the gain it results in more noise. If you adjust the **Blur-noise trade-off** towards **Low noise**, the exposure will prefer longer exposure times over sensor gain when the exposure is increased, and the opposite if you adjust the trade-off towards **Low motion blur**. Both the gain and exposure time will eventually reach their maximum values in low-light conditions, regardless of the priority set.

Lock aperture  : Turn on to keep the aperture size set by the **Aperture** slider. Turn off to allow the camera to automatically adjust the aperture size. You can, for example, lock the aperture for scenes with permanent light conditions.

Aperture  : Use the slider to adjust the aperture size, that is, how much light passes through the lens. To allow more light to enter the sensor and thereby produce a brighter image in low-light conditions, move the slider towards **Open**. An open aperture also reduces the depth of field, which means that objects close to or far from the camera can appear unfocused. To allow more of the image to be in focus, move the slider towards **Closed**.

Exposure level: Use the slider to adjust the image exposure.

Defog  : Turn on to detect the effects of foggy weather and automatically remove them for a clearer image.

AXIS M11-E Mk II Series

The device interface

Note

We recommend you not to turn on **Defog** in scenes with low contrast, large light level variations, or when the autofocus is slightly off. This can affect the image quality, for example, by increasing the contrast. Furthermore, too much light can negatively impact the image quality when defog is active.

Image correction

Important

We recommend you not to use multiple image correction features at the same time, since it can lead to performance issues.

Barrel distortion correction (BDC)  : Turn on to get a straighter image if it suffers from barrel distortion. Barrel distortion is a lens effect that makes the image appear curved and bent outwards. The condition is seen more clearly when the image is zoomed out.

Crop  : Use the slider to adjust the correction level. A lower level means that the image width is kept at the expense of image height and resolution. A higher level means that image height and resolution are kept at the expense of image width.

Remove distortion  : Use the slider to adjust the correction level. Pucker means that the image width is kept at the expense of image height and resolution. Bloat means that image height and resolution are kept at the expense of image width.

Electronic image stabilization (EIS)  : Turn on to get a smoother and steadier image with less blur. We recommend you to use EIS in environments where the device is mounted in an exposed location and subject to vibrations due to, for example, wind or passing traffic.

Focal length  : Use the slider to adjust the focal length. A higher value leads to higher magnification and a narrower angle of view, while a lower value leads to a lower magnification and a wider angle of view.

Stabilizer margin  : Use the slider to adjust the size of the stabilizer margin, which determines the level of vibration to stabilize. If the product is mounted in an environment with a lot of vibration, move the slider towards **Max**. As a result, a smaller scene is captured. If the environment has less vibration, move the slider towards **Min**.

Straighten image  : Turn on and use the slider to straighten the image horizontally by rotating and cropping it digitally. The functionality is useful when it's not possible to mount the camera exactly level. Ideally, straighten the image during installation.



: Click to show a supporting grid in the image.



: Click to hide the grid.

AXIS M11-E Mk II Series

The device interface

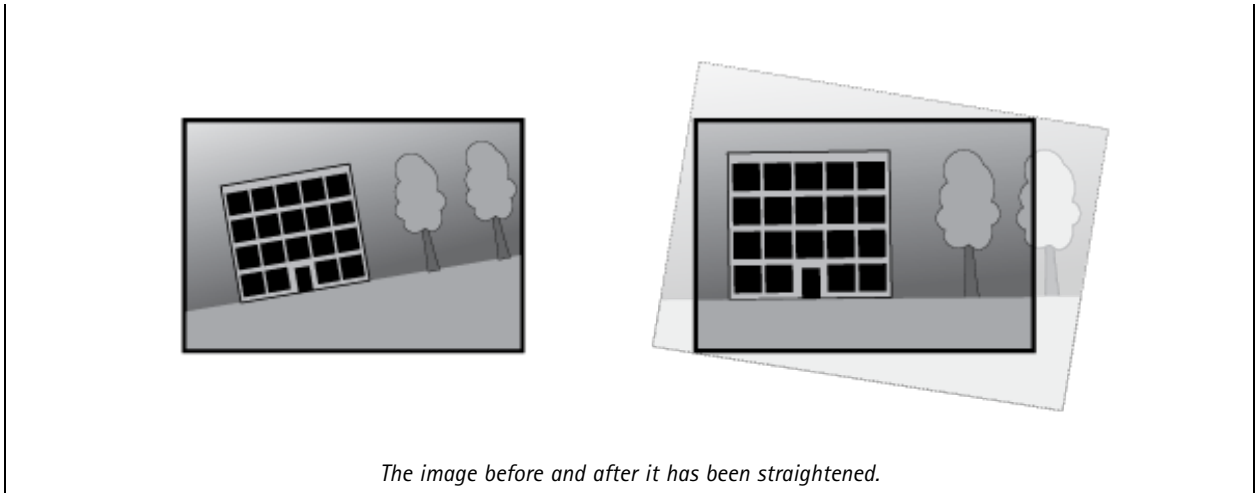

Stream

General

Resolution: Select the image resolution suitable for the surveillance scene. A higher resolution increases bandwidth and storage.

Frame rate: To avoid bandwidth problems on the network or reduce storage size, you can limit the frame rate to a fixed amount. If you leave the frame rate at zero, the frame rate is kept at the highest possible rate under the current conditions. A higher frame rate requires more bandwidth and storage capacity.

Compression: Use the slider to adjust the image compression. High compression results in a lower bitrate and lower image quality. Low compression improves the image quality, but uses more bandwidth and storage when you record.

Signed video: Turn on to add the signed video feature to the video. Signed video protects the video from tampering by adding cryptographic signatures to the video.

H.26x encoding

Zipstream: A bitrate reduction technology, optimized for video surveillance, that reduces the average bitrate in an H.264 or H.265 stream in real time. Axis Zipstream applies a high bitrate in scenes where there are multiple regions of interest, for example in scenes with moving objects. When the scene is more static, Zipstream applies a lower bitrate, and thereby reduces the required storage. To learn more, see *Reducing the bit rate with Axis Zipstream*

Select the desired level of bitrate reduction:

- **Off:** No bitrate reduction.
- **Low:** No visible quality degradation in most scenes. This is the default option and it can be used in all types of scenes to reduce the bitrate.
- **Medium:** Visible effects in some scenes through less noise and a slightly lower level of detail in regions of lower interest, for example where there's no movement.
- **High:** Visible effects in some scenes through less noise and a lower level of detail in regions of lower interest, for example where there's no movement. We recommend this level for cloud-connected devices and devices that use local storage.
- **Higher:** Visible effects in some scenes through less noise and a lower level of detail in regions of lower interest, for example where there's no movement.
- **Extreme:** Visible effects in most scenes. The bitrate is optimized for smallest possible storage.

Dynamic FPS (frames per second): Turn on to allow the bandwidth to vary based on the level of activity in the scene. More activity requires more bandwidth.

Lower limit ⓘ : Enter a value to adjust the frame rate between minimal fps and the stream default fps based on scene motion. We recommend you to use lower limit in scenes with very little motion, where the fps could drop to 1 or lower.

AXIS M11-E Mk II Series

The device interface

Dynamic GOP (Group of Pictures): Turn on to dynamically adjust the interval between I-frames based on the level of activity in the scene.



Upper limit  : Enter a maximum GOP length, that is, the maximum number of P-frames between two I-frames.

P-frames: Enter the desired number of P-frames. The higher the number, the less bandwidth is required. However, if there are network congestion, there could be a noticeable deterioration in the video quality.

H.264 profile:

- **Baseline**  : Use if the video management client doesn't support CABAC entropy coding.
- **Main:** Use if the video management client supports CABAC entropy coding, to achieve higher compression with maintained video quality. It requires more processing power to decode compared to the baseline profile.
- **High:** Use if the video management client supports CABAC entropy coding, to achieve even higher compression than with the main profile. It requires more processing power to decode compared to the main profile.

Bitrate control:

- **Average:** Select to automatically adjust the bitrate over a longer time period and provide the best possible image quality based on the available storage.
 -  Click to calculate the target bitrate based on available storage, retention time, and bitrate limit.
 - **Target bitrate:** Enter desired target bitrate.
 - **Retention time:** Enter the number of days to keep the recordings.
 - **Storage:** Shows the estimated storage that can be used for the stream.
 - **Maximum bitrate:** Turn on to set a bitrate limit.
 - **Bitrate limit**  : Enter a bitrate limit that is higher than the target bitrate.
- **Maximum:** Select to set a maximum instant bitrate of the stream based on your network bandwidth.
 - **Maximum:** Enter the maximum bitrate.
- **Variable:** Select to allow the bitrate to vary based on the level of activity in the scene. More activity requires more bandwidth. We recommend this option for most situations.

Orientation

Rotate  : Rotate the image to match your requirements.

Mirror: Turn on to mirror the image.

Audio

Include: Turn on to use audio in the video stream.

Source  : Select what audio source to use.







Stereo  : Turn on to include built-in audio as well as audio from an external microphone.

AXIS M11-E Mk II Series

The device interface

Overlays

 : Click to add an overlay. Select the type of overlay from the dropdown list:

- **Text:** Select to show a text that is integrated in the live view image and visible in all views, recordings and snapshots. You can enter your own text, and you can also include pre-configured modifiers to automatically show for example time, date, frame rate.
 -  : Click to add the date modifier %F to show yyyy-mm-dd.
 -  : Click to add the time modifier %X to show hh:mm:ss (24-hour clock).
 -  : Click to select any of the modifiers shown in the list to add them to the text box. For example, %a shows the day of the week.
 - **Size:** Select the desired font size.
 - **Appearance:** Select the text color and background color, for example, white text on a black background (default).
 -  : Select the position of the overlay in the image.
- **Image:** Select to show a static image superimposed over the video stream. You can use .bmp, .png, .jpeg, or .svg files. To upload an image, click **Images**. Before you upload an image, you can choose to:
 - **Scale with resolution:** Select to automatically scale the overlay image to fit the video resolution.
 - **Use transparency:** Select and enter the RGB hexadecimal value for that color. Use the format RRGGBB. Examples of hexadecimal values: FFFFFFFF for white, 000000 for black, FF0000 for red, 6633FF for blue, and 669900 for green. Only for .bmp images.
- **Streaming indicator**  : Select to show an animation superimposed over the video stream. The animation indicates that the video stream is live, even if the scene doesn't contain any motion.
 - **Appearance:** Select the animation color and background color, for example, red animation on a transparent background (default).
 - **Size:** Select the desired font size.
 -  : Select the position of the overlay in the image.

View areas

 : Click to create a view area.

 Click the view area to access settings.

Name: Enter a name for the view area. The maximum length is 64 characters.

Aspect ratio: Select desired aspect ratio. The resolution adjusts automatically.

PTZ: Turn on to use pan, tilt, and zoom functionality in the view area.

AXIS M11-E Mk II Series

The device interface

Privacy masks

 : Click to create a new privacy mask. The maximum number of masks depend on the complexity of all masks combined. Each mask can have maximum 10 anchor points.

Privacy masks: Click to change the color of all privacy masks, or to delete all privacy masks permanently.

 Mask x: Click to rename, disable, or permanently delete the mask.

Audio

Device settings

Input: Turn on or off audio input. Shows the type of input.

Allow stream extraction: Turn on to allow stream extraction.

Input type: Select the type of input, for instance if it's a microphone or line-in.

Power type: Select power type for your input.

Activate changes: Click to activate your selection.

Separate gain controls: Turn on to adjust the gain separately for the different input types.

Automatic gain control  : Turn on to dynamically adapt the gain to changes in the sound.

Gain: Use the slider to change the gain. Click the microphone icon to mute or unmute.

Output  : Shows the type of output.

Gain: Use the slider to change the gain. Click the speaker icon to mute or unmute.

Stream

Encoding: Select the encoding to use for the input source streaming. You can only choose encoding if audio input is turned on. If audio input is turned off, click **Enable audio input** to turn it on.

Audio mixer

Input

Ten Band Graphic Audio Equalizer: Turn on to adjust the level of different frequency bands within an audio signal.

Voice enhancement  : Turn on to adjust the voice content in relation to other sounds.

AXIS M11-E Mk II Series

The device interface

Recordings

 Click to filter the recordings.

From: Show recordings done after a certain point in time.

To: Show recordings up until a certain point in time.

Source ⓘ : Show recordings based on source.

Event: Show recordings based on events.

Storage: Show recordings based on storage type.

 Click to play the recording.

 Click to stop the recording.

 Click to show more information and options about the recording.

Set export range: If you only want to export part of the recording, enter from when to when.

 Click to delete the recording.

Export: Click to export (part of) the recording.

Apps

Add app: Click to install a new app.

Find more apps: Click to go to an overview page of Axis apps.

 The context menu contains:

- **App log:** Click to view a log of the app events. The log is helpful when you contact support.
- **Activate license with a key:** If the app requires a license, you need to activate it. Use this option if your device doesn't have internet access.
If you don't have a license key, go to axis.com/applications. You need a license code and the Axis product serial number to generate a license key.
- **Activate license automatically:** If the app requires a license, you need to activate it. Use this option if your device has internet access. You need a license code to activate the license.
- **Deactivate the license:** Deactivate the license to use it in another device. If you deactivate the license, you also remove it from the device. To deactivate the license requires internet access.
- **Delete:** Delete the app permanently from the device. If you don't deactivate the license first, it remains active.

Note

The device's performance might be affected if you run several apps at the same time.

Start: Start or stop the app.

Open: Click to access the app's settings. The available settings depend on the application. Some applications don't have any settings.

AXIS M11-E Mk II Series

The device interface

System

Date and time

The time format depends on the web browser's language settings.

Note

We recommend you to synchronize the device's date and time with an NTP server.

Synchronization: Select an option for synchronizing the device's date and time.

- **Automatic date and time (NTP server using DHCP):** Synchronize with the NTP server connected to the DHCP server.
- **Automatic date and time (manual NTP server):** Synchronize with NTP servers of your choice.
 - **Primary NTP server and Secondary NTP server:** Enter the IP address of one or two NTP servers. When you use two NTP servers, the device synchronizes and adapts its time based on input from both.
- **Custom date and time:** Manually set the date and time. Click **Get from system** to fetch the date and time settings once from your computer or mobile device.

Time zone: Select which time zone to use. Time will be automatically adjusted for daylight saving time and standard time.

Note

The system uses the date and time settings in all recordings, logs and system settings.

Network

IPv4 and IPv6

IPv4

- **Automatic IP (DHCP) and DNS (DHCP):** The recommended setting for most networks. The current settings are updated automatically.
- **Automatic IP (DHCP) and manual DNS:** Contact your network administrator to configure the manual settings. The current automatic settings are updated automatically.
- **Manual IP and DNS:** Contact your network administrator to configure the settings.

IP address: Enter a unique IP address for the device. Static IP addresses can be assigned at random within isolated networks, provided that each address is unique. To avoid conflicts, we recommend you to contact your network administrator before you assign a static IP address.

Subnet mask: Enter the subnet mask.

Router: Enter the IP address of the default router (gateway) used to connect devices that are attached to different networks and network segments.

Hostname: Enter the hostname.

Search domains: When you use a hostname that is not fully qualified, click **Add search domain** and enter a domain in which to search for the hostname used by the device.

DNS servers: Click **Add DNS server** and enter the IP address of the primary DNS server. This provides the translation of hostnames to IP addresses on your network.

IPv6

Assign IPv6 automatically: Select to let the network router assign an IP address to the device automatically.

HTTP and HTTPS

AXIS M11-E Mk II Series

The device interface

Allow access through: Select if a user is allowed to connect to the device through the HTTP, HTTPS, or both HTTP and HTTPS protocols.

HTTPS is a protocol that provides encryption for page requests from users and for the pages returned by the web server. The encrypted exchange of information is governed by the use of an HTTPS certificate, which guarantees the authenticity of the server.

To use HTTPS on the device, you must install an HTTPS certificate. Go to **System > Security** to create and install certificates.

Note

If you view encrypted web pages through HTTPS, you might experience a drop in performance, especially when you request a page for the first time.

HTTP port: Enter the HTTP port to use. Port 80 or any port in the range 1024–65535 are allowed. If you are logged in as an administrator, you can also enter any port in the range 1–1023. If you use a port in this range, you get a warning.

HTTPS port: Enter the HTTPS port to use. Port 443 or any port in the range 1024–65535 are allowed. If you are logged in as an administrator, you can also enter any port in the range 1–1023. If you use a port in this range, you get a warning.

Certificate: Select a certificate to enable HTTPS for the device.

Friendly name

Bonjour®: Turn on to allow automatic discovery on the network.

Bonjour name: Enter a friendly name to be visible on the network. The default name is the device name and MAC address.

Use UPnP®: Turn on to allow automatic discovery on the network.

UPnP name: Enter a friendly name to be visible on the network. The default name is the device name and MAC address.

One-click cloud connection

One-click cloud connection (O3C) together with an O3C service provides easy and secure internet access to live and recorded video from any location. For more information, see axis.com/end-to-end-solutions/hosted-services.

Allow O3C:

- **One-click:** The default setting. Press and hold the control button on the device to connect to an O3C service over the internet. You need to register the device with the O3C service within 24 hours after you press the control button. Otherwise, the device disconnects from the O3C service. Once you have registered the device, **Always** is enabled and the device stays connected to the O3C service.
- **Always:** The device constantly attempts to connect to an O3C service over the internet. Once you have registered the device, it stays connected to the O3C service. Use this option if the control button on the device is out of reach.
- **No:** Disables the O3C service.

Proxy settings: If needed, enter the proxy settings to connect to the HTTP server.

Host: Enter the proxy server's address.

Port: Enter the port number used for access.

Login and Password: If needed, enter username and password for the proxy server.

Authentication method:

- **Basic:** This method is the most compatible authentication scheme for HTTP. It's less secure than the **Digest** method because it sends the username and password unencrypted to the server.
- **Digest:** This method is more secure because it always transfers the password encrypted across the network.
- **Auto:** This option lets the device select the authentication method depending on the supported methods. It prioritizes the **Digest** method over the **Basic** method.

Owner authentication key (OAK): Click **Get key** to fetch the owner authentication key. This is only possible if the device is connected to the internet without a firewall or proxy.

AXIS M11-E Mk II Series

The device interface

SNMP

The Simple Network Management Protocol (SNMP) allows remote management of network devices.

SNMP: Select the version of SNMP to use.

- **v1 and v2c:**
 - **Read community:** Enter the community name that has read-only access to all supported SNMP objects. The default value is **public**.
 - **Write community:** Enter the community name that has read/write access to all supported SNMP objects (except read-only objects). The default value is **write**.
 - **Activate traps:** Turn on to activate trap reporting. The device uses traps to send messages for important events or status changes to a management system. In the device interface, you can set up traps for SNMP v1 and v2c. Traps are automatically turned off if you change to SNMP v3 or turn off SNMP. If you use SNMP v3, you can set up traps through the SNMP v3 management application.
 - **Trap address:** Enter the IP address or host name of the management server.
 - **Trap community:** Enter the community to use when the device sends a trap message to the management system.
 - **Traps:**
 - **Cold start:** Sends a trap message when the device starts.
 - **Warm start:** Sends a trap message when you change an SNMP setting.
 - **Link up:** Sends a trap message when a link changes from down to up.
 - **Authentication failed:** Sends a trap message when an authentication attempt fails.

Note

All Axis Video MIB traps are enabled when you turn on SNMP v1 and v2c traps. For more information, see *AXIS OS Portal > SNMP*.

- **v3:** SNMP v3 is a more secure version, which provides encryption and secure passwords. To use SNMP v3, we recommend you to activate HTTPS, as the password is then sent through HTTPS. This also prevents unauthorized parties to access unencrypted SNMP v1 and v2c traps. If you use SNMP v3, you can set up traps through the SNMP v3 management application.
 - **Password for the account "initial":** Enter the SNMP password for the account named "initial". Although the password can be sent without activating HTTPS, we don't recommend it. The SNMP v3 password can only be set once, and preferably only when HTTPS is enabled. Once the password is set, the password field is no longer displayed. To set the password again, you must reset the device to factory default settings.

Connected clients

The list shows all clients that are connected to the device.

Update: Click to refresh the list.

Security

Certificates

Certificates are used to authenticate devices on a network. The device supports two types of certificates:

- **Client/server certificates**
A client/server certificate validates the device's identity, and can be self-signed or issued by a Certificate Authority (CA). A self-signed certificate offers limited protection and can be used before a CA-issued certificate has been obtained.
- **CA certificates**
You can use a CA certificate to authenticate a peer certificate, for example to validate the identity of an authentication server when the device connects to a network protected by IEEE 802.1X. The device has several pre-installed CA certificates.

These formats are supported:

- Certificate formats: .PEM, .CER, and .PFX
- Private key formats: PKCS#1 and PKCS#12

AXIS M11-E Mk II Series

The device interface

Important

If you reset the device to factory default, all certificates are deleted. Any pre-installed CA certificates are reinstalled.



Filter the certificates in the list.



Add certificate : Click to add a certificate.



The context menu contains:

- **Certificate information:** View an installed certificate's properties.
- **Delete certificate:** Delete the certificate.
- **Create certificate signing request:** Create a certificate signing request to send to a registration authority to apply for a digital identity certificate.

IEEE 802.1x

IEEE 802.1x is an IEEE standard for port-based network admission control providing secure authentication of wired and wireless network devices. IEEE 802.1x is based on EAP (Extensible Authentication Protocol).

To access a network protected by IEEE 802.1x, network devices must authenticate themselves. The authentication is performed by an authentication server, typically a RADIUS server (for example FreeRADIUS and Microsoft Internet Authentication Server).

Certificates

When configured without a CA certificate, server certificate validation is disabled and the device tries to authenticate itself regardless of what network it is connected to.

When using a certificate, in Axis' implementation, the device and the authentication server authenticate themselves with digital certificates using EAP-TLS (Extensible Authentication Protocol - Transport Layer Security).

To allow the device to access a network protected through certificates, a signed client certificate must be installed on the device.

Client certificate: Select a client certificate to use IEEE 802.1x. The authentication server uses the certificate to validate the client's identity.

CA certificate: Select a CA certificate to validate the authentication server's identity. When no certificate is selected, the device tries to authenticate itself regardless of what network it is connected to.

EAP identity: Enter the user identity associated with the client certificate.

EAPOL version: Select the EAPOL version that is used in the network switch.

Use IEEE 802.1x: Select to use the IEEE 802.1x protocol.

Prevent brute-force attacks

Blocking: Turn on to block brute-force attacks. A brute-force attack uses trial-and-error to guess login info or encryption keys.

Blocking period: Enter the number of seconds to block a brute-force attack.

Blocking conditions: Enter the number of authentication failures allowed per second before the block starts. You can set the number of failures allowed both on page level and device level.

IP address filter

AXIS M11-E Mk II Series

The device interface

Use filter: Select to filter which IP addresses that are allowed to access the device.

Policy: Choose whether to **Allow** access or **Deny** access for certain IP addresses.

Addresses: Enter the IP numbers that are either allowed or denied access to the device. You can also use the CIDR format.

Custom-signed firmware certificate

To install test firmware or other custom firmware from Axis on the device, you need a custom-signed firmware certificate. The certificate verifies that the firmware is approved by both the device owner and Axis. The firmware can only run on a specific device which is identified by its unique serial number and chip ID. Custom-signed firmware certificates can only be created by Axis, since Axis holds the key to sign them.

Click **Install** to install the certificate. You need to install the certificate before you install the firmware.

Users



Add user: Click to add a new user. You can add up to 100 users.

Username: Enter a unique username.

New password: Enter a password for the user. Passwords must be 1 to 64 characters long. Only ASCII printable characters (code 32 to 126) are allowed in the password, for example letters, numbers, punctuation, and some symbols.

Repeat password: Enter the same password again.

Role:

- **Administrator:** Has full access to all settings. Administrators can also add, update, and remove other users.
- **Operator:** Has access to all settings except:
 - All **System** settings.
 - Adding apps.
- **Viewer:** Has access to:
 - Watch and take snapshots of a video stream.
 - Watch and export recordings.
 - With PTZ user access: pan, tilt, and zoom.



The context menu contains:

Update user: Edit the user's properties.

Delete user: Delete the user. You can't delete the root user.

Anonymous users

Allow anonymous viewers: Turn on to allow anyone to access the device as a viewer without having to log in with a user account.

Allow anonymous PTZ operators: Turn on to allow anonymous users to pan, tilt, and zoom the image.

Events

Rules

AXIS M11-E Mk II Series

The device interface

A rule defines the conditions that must be met for the product to perform an action. The list shows all the currently configured rules in the product.

Note

You can create up to 256 action rules.



Add a rule: Click to create a rule.

Name: Enter a name for the rule.

Wait between actions: Enter the minimum time (hh:mm:ss) that must pass between rule activations. It is useful if the rule is activated by for example day-night mode conditions, to avoid that small light changes during sunrise and sunset activate the rule repeatedly.

Condition: Select a condition from the list. A condition must be met for the device to perform an action. If multiple conditions are defined, all of them must be met to trigger the action. For information about specific conditions, see *Get started with rules for events*.

Use this condition as a trigger: Select to make this first condition function only as a starting trigger. It means that once the rule is activated it remains active for as long as all the other conditions are met, no matter the state of the first condition. If you don't select this option, the rule will simply be active whenever all the conditions are met.

Invert this condition: Select if you want the condition to be the opposite of your selection.



Add a condition: Click to add an additional condition.

Action: Select an action from the list and enter its required information. For information about specific actions, see *Get started with rules for events*.

Recipients

You can set up your device to notify recipients about events or send files. The list shows all the recipients currently configured in the product, along with information about their configuration.

Note

You can create up to 20 recipients.



Add a recipient: Click to add a recipient.

Name: Enter a name for the recipient.

Type: Select from the list:

- **FTP**
 - **Host:** Enter the server's IP address or hostname. If you enter a hostname, make sure that a DNS server is specified under **System > Network > IPv4 and IPv6**.
 - **Port:** Enter the port number used by the FTP server. The default is 21.
 - **Folder:** Enter the path to the directory where you want to store files. If this directory doesn't already exist on the FTP server, you will get an error message when uploading files.
 - **Username:** Enter the username for the login.
 - **Password:** Enter the password for the login.
 - **Use temporary file name:** Select to upload files with temporary, automatically generated filenames. The files get renamed to the desired names when the upload completes. If the upload is aborted/interrupted, you don't get any corrupt files. However, you probably still get the temporary files. This way you know that all files that have the desired name, are correct.

AXIS M11-E Mk II Series

The device interface

- Use **passive FTP**: Under normal circumstances the product simply requests the target FTP server to open the data connection. The device actively initiates both the FTP control and data connections to the target server. This is normally needed if there is a firewall between the device and the target FTP server.
- **HTTP**
 - **URL**: Enter the network address to the HTTP server and the script that will handle the request. For example: `http://192.168.254.10/cgi-bin/notify.cgi`.
 - **Username**: Enter the username for the login.
 - **Password**: Enter the password for the login.
 - **Proxy**: Turn on and enter the required information if a proxy server must be passed to connect to the HTTP server.
- **HTTPS**
 - **URL**: Enter the network address to the HTTPS server and the script that will handle the request. For example: `https://192.168.254.10/cgi-bin/notify.cgi`.
 - **Validate server certificate**: Select to validate the certificate that was created by HTTPS server.
 - **Username**: Enter the username for the login.
 - **Password**: Enter the password for the login.
 - **Proxy**: Turn on and enter the required information if a proxy server must be passed to connect to the HTTPS server.
- **Network storage**

You can add network storage such as a NAS (Network Attached Storage) and use it as a recipient to store files. The files are stored in the Matroska (MKV) file format.

 - **Host**: Enter the IP address or hostname for the network storage.
 - **Share**: Enter the name of the share on the host.
 - **Folder**: Enter the path to the directory where you want to store files.
 - **Username**: Enter the username for the login.
 - **Password**: Enter the password for the login.
- **SFTP**
 - **Host**: Enter the server's IP address or hostname. If you enter a hostname, make sure that a DNS server is specified under **System > Network > IPv4 and IPv6**.
 - **Port**: Enter the port number used by the SFTP server. The default is 22.
 - **Folder**: Enter the path to the directory where you want to store files. If this directory doesn't already exist on the SFTP server, you will get an error message when uploading files.
 - **Username**: Enter the username for the login.
 - **Password**: Enter the password for the login.
 - **SSH host public key (MD5)**: Enter the fingerprint of the remote host's public key (a 32 hexadecimal digits string). The SFTP client supports SFTP servers using SSH-2 with RSA, DSA, ECDSA, and ED25519 host key types. RSA is the preferred method during negotiation, followed by ECDSA, ED25519, and DSA. Make sure to enter the right MD5 host key that is used by your SFTP server.
 - **Use temporary file name**: Select to upload files with temporary, automatically generated filenames. The files get renamed to the desired names when the upload completes. If the upload is aborted/interrupted, you don't get any corrupt files. However, you probably still get the temporary files. This way you know that all files that have the desired name, are correct.
- **Email**
 - **Send email to**: Enter the email address to send emails to. To enter multiple addresses, use commas to separate them.
 - **Send email from**: Enter the email address of the sending server.
 - **Username**: Enter the username for the mail server. Leave this field empty if the mail server does not require authentication.
 - **Password**: Enter the password for the mail server. Leave this field empty if the mail server does not require authentication.
 - **Email server (SMTP)**: Enter the name of the SMTP server, for example `smtp.gmail.com`, `smtp.mail.yahoo.com`.
 - **Port**: Enter the port number for the SMTP server, using values in the range 0-65535. The default value is 587.
 - **Encryption**: To use encryption, select either SSL or TLS.
 - **Validate server certificate**: If you use encryption, select to validate the identity of the device. The certificate can be self-signed or issued by a Certificate Authority (CA).
 - **POP authentication**: Turn on to enter the name of the POP server, for example `pop.gmail.com`.

Note

Some email providers have security filters that prevent users from receiving or viewing large amount of attachments, from receiving scheduled emails and similar. Check the email provider's security policy to avoid your email account being locked or missing out on your expected emails.

AXIS M11-E Mk II Series

The device interface

- TCP
 - **Host:** Enter the server's IP address or hostname. If you enter a hostname, make sure that a DNS server is specified under **System > Network > IPv4 and IPv6**.
 - **Port:** Enter the port number used to access the server.

Test: Click to test the setup.



The context menu contains:

View recipient: Click to view all the recipient details.

Copy recipient: Click to copy a recipient. When you copy, you can make changes to the new recipient.

Delete recipient: Click to delete the recipient permanently.

Schedules

Schedules and pulses can be used as conditions in rules. The list shows all the schedules and pulses currently configured in the product, along with information about their configuration.



Add schedule: Click to create a schedule or pulse.

Manual trigger

The manual trigger is used to manually trigger a rule. The manual trigger can for example be used to validate actions during product installation and configuration.

MQTT

MQTT (Message Queuing Telemetry Transport) is a standard messaging protocol for the Internet of Things (IoT). It was designed for simplified IoT integration and is used in a wide variety of industries to connect remote devices with a small code footprint and minimal network bandwidth. The MQTT client in Axis device firmware can simplify integration of data and events produced in the device to systems which are not video management systems (VMS).

Set up the device as an MQTT client. MQTT communication is based on two entities, the clients and the broker. The clients can send and receive messages. The broker is responsible for routing messages between clients.

You can learn more about MQTT in *AXIS OS Portal*.

MQTT client

Connect: Turn on or off the MQTT client.

Status: Shows the current status of the MQTT client.

Broker

Host: Enter the hostname or IP address of the MQTT server.

Protocol: Select which protocol to use.

Port: Enter the port number.

- 1883 is the default value for **MQTT over TCP**
- 8883 is the default value for **MQTT over SSL**
- 80 is the default value for **MQTT over WebSocket**
- 443 is the default value for **MQTT over WebSocket Secure**

Username: Enter the username that the client will use to access the server.

AXIS M11-E Mk II Series

The device interface

Password: Enter a password for the username.

Client ID: Enter a client ID. The client identifier is sent to the server when the client connects to it.

Clean session: Controls the behavior at connection and disconnection time. When selected, the state information is discarded at connect and disconnect.

Keep alive interval: The keep alive interval enables the client to detect when the server is no longer available without having to wait for the long TCP/IP timeout.

Timeout: The time interval in seconds to allow a connect to complete. Default value: 60

Device topic prefix: Used in the default values for the topic in the connect message and LWT message on the **MQTT client** tab, and in the publication conditions on the **MQTT publication** tab.

Reconnect automatically: Specifies whether the client should reconnect automatically after a disconnect.

Connect message

Specifies if a message should be sent out when a connection is established.

Send message: Turn on to send messages.

Use default: Turn off to enter your own default message.

Topic: Enter the topic for the default message.

Payload: Enter the content for the default message.

Retain: Select to keep the state of client on this **Topic**

QoS: Change the QoS layer for the packet flow.

Last Will and Testament message

The Last Will Testament (LWT) lets a client provide a testament along with its credentials when connecting to the broker. If the client disconnects ungracefully at some point later (maybe because his power source died), it can let the broker deliver a message to other clients. This LWT message has the same form as an ordinary message and gets routed via the same mechanics.

Send message: Turn on to send messages.

Use default: Turn off to enter your own default message.

Topic: Enter the topic for the default message.

Payload: Enter the content for the default message.

Retain: Select to keep the state of client on this **Topic**

QoS: Change the QoS layer for the packet flow.

MQTT publication

AXIS M11-E Mk II Series

The device interface

Use default condition prefix: Select to use the default condition prefix, that is defined using the device topic prefix in the MQTT client tab.

Include condition name: Select to include the topics that describe the condition in the MQTT topic.

Include condition namespaces: Select to include ONVIF topic namespaces in the MQTT topic.

Include serial number: Select to include the device's serial number in the MQTT payload.



Add condition: Click to add a condition.

Retain: Defines which MQTT messages are sent as retained.

- **None:** Send all messages as non-retained.
- **Property:** Send only stateful messages as retained.
- **All:** Send both stateful and stateless messages as retained.

QoS: Select the desired level for the MQTT publication.

MQTT subscriptions



Add subscription: Click to add a new MQTT subscription.

Subscription filter: Enter the MQTT topic that you want to subscribe to.

Use device topic prefix: Add the subscription filter as prefix to the MQTT topic.

Subscription type:

- **Stateless:** Select to convert MQTT messages into a stateless message.
- **Stateful:** Select to convert MQTT messages into a condition. The payload is used as the state.

QoS: Select the desired level for the MQTT subscription.

Storage

Network storage

Add network storage: Click to add a network share where you can save recordings.

- **Address:** Enter the IP address or host name of the host server, typically a NAS (Network Attached Storage). We recommend you to configure the host to use a fixed IP address (not DHCP since a dynamic IP address can change) or that you use DNS. Windows SMB/CIFS names are not supported.
- **Network share:** Enter the name of the shared location on the host server. Several Axis devices can use the same network share, since each device gets its own folder.
- **User:** If the server requires a login, enter the username. To log in to a specific domain server, type DOMAIN\username.
- **Password:** If the server requires a login, enter the password.
- **SMB version:** Select the SMB storage protocol version to connect to the NAS. If you select **Auto**, the device tries to negotiate one of the secure versions SMB: 3.02, 3.0, or 2.1. Select 1.0 or 2.0 to connect to older NAS that don't support higher versions. You can read more about SMB support in Axis devices [here](#).
- **Add share even if connection test fails:** Select to add the network share even if an error is discovered during the connection test. The error can be, for example, that you didn't enter a password even though the server requires one.

Remove network storage: Click to remove the connection to the network share. This removes all settings for the network share.

Write protect: Turn on to stop writing to the network share and protect recordings from being removed. You can't format a write-protected network share.

Ignore: Turn on to stop storing recordings on the network share.

AXIS M11-E Mk II Series

The device interface

Retention time: Select how long to keep recordings, to limit the amount of old recordings or to comply with regulations regarding data storage. If the network storage becomes full, old recordings are removed before the selected time period has passed.

Tools

- **Test connection:** Test the connection to the network share.
- **Format:** Format the network share, for example when you need to quickly erase all data. cifs is the available file system option.

Click **Use tool** to activate the selected tool.

Onboard storage

Important

Risk of data loss and corrupted recordings. Do not remove the SD card while the device is running. Unmount the SD card before you remove it.

Unmount: Click to safely remove the SD card.

Write protect: Turn on to stop writing to the SD card and protect recordings from being removed. You can't format a write-protected SD card.

Autoformat: Turn on to automatically format a newly inserted SD card. It formats the file system into ext4.

Ignore: Turn on to stop storing recordings on the SD card. When you ignore the SD card, the device no longer recognizes that the card exists. The setting is only available for administrators.

Retention time: Select how long to keep recordings, to limit the amount of old recordings or to comply with regulations regarding data storage. If the SD card becomes full, old recordings are removed before the selected time period has passed.

Tools

- **Check:** Check for errors on the SD card. This only works for the ext4 file system.
- **Repair:** Repair errors in the ext4 file system. To repair an SD card with the VFAT file system, eject the SD card, insert it in a computer and perform a disk repair.
- **Format:** Format the SD card, for example when you need to change the file system or quickly erase all data. VFAT and ext4 are the two available file system options. The recommended format is ext4, due to its resilience against data loss if the card is ejected or if there is an abrupt power loss. However, you need a third-party ext4 driver or application to access the file system from Windows®.
- **Encrypt:** Encrypt data that is stored.
- **Decrypt:** Decrypt data that is stored.
- **Change password:** Change the password required to encrypt the SD card.

Click **Use tool** to activate the selected tool.

Stream profiles

Click  to create and save groups of video stream settings. You can use the settings in different situations, for example in continuous recording or when you use action rules to record.

ONVIF

ONVIF users

AXIS M11-E Mk II Series

The device interface

ONVIF (Open Network Video Interface Forum) is a global interface standard that makes it easier for end-users, integrators, consultants, and manufacturers to take advantage of the possibilities offered by network video technology. ONVIF enables interoperability between different vendor products, increased flexibility, reduced cost and future-proof systems.



Add user: Click to add a new ONVIF user.

Username: Enter a unique username.

New password: Enter a password for the user. Passwords must be 1 to 64 characters long. Only ASCII printable characters (code 32 to 126) are allowed in the password, for example letters, numbers, punctuation, and some symbols.

Repeat password: Enter the same password again

Role:

- **Administrator:** Has full access to all settings. Administrators can also add, update, and remove other users.
- **Operator:** Has access to all settings except:
 - All **System** settings.
 - Adding apps.
- **Media user:** Allows access to the video stream only.



The context menu contains:

Update user: Edit the user's properties.

Delete user: Delete the user. You can't delete the root user.

By creating an ONVIF user, you automatically enable ONVIF communication. Use the username and password for all ONVIF communication with the device. For more information see the Axis Developer Community at axis.com.

ONVIF media profiles

An ONVIF media profile consists of a set of configurations that you can use to change media stream settings.



Add media profile: Click to add a new ONVIF media profile.

profile_x: Click a profile to edit.

Analytics metadata

Metadata producers

Metadata producers lists the channels used by apps and the metadata they are streaming from the device.

Producer: The app producing the metadata.

Channel: The channel used by the app. Check to enable the metadata stream. Uncheck to disable the stream for compatibility or resources management reasons.

Detectors

Camera tampering

AXIS M11-E Mk II Series

The device interface

The camera tampering detector generates an alarm when the scene changes, for example because the lens is covered, sprayed or severely put out of focus, and the time in **Trigger after** has passed. The tampering detector only activates when the camera has not moved for at least 10 seconds. During this period the detector sets up a scene model to use as a comparison to detect tampering in current images. For the scene model to be set up properly, make sure that the camera is in focus, the lighting conditions are correct, and the camera doesn't point at a scene that lacks contours, for example a blank wall. Camera tampering can be used as a condition to trigger actions.

Trigger after: Enter the minimum time that the tampering conditions must be active before the alarm triggers. This can help prevent false alarms for known conditions that affect the image.

Trigger on dark images: It is very difficult to generate alarms when the camera lens is sprayed, since it is impossible to distinguish that event from other situations where the image turns dark in a similar way, for example when the lighting conditions change. Turn on this parameter to generate alarms for all cases where the image turns dark. When it's turned off, the device doesn't generate any alarm when the image turns dark.

Audio detection

These settings are available for each audio input.

Sound level: Adjust the sound level to a value from 0–100, where 0 is the most sensitive and 100 the least sensitive. Use the activity indicator as a guide when you set the sound level. When you create events, you can use the sound level as a condition. You can choose to trigger an action if the sound level rises above, falls below or passes the set value.

Accessories

Network speaker pairing

Network speaker pairing allows you to use a compatible Axis network speaker as if it is connected directly to the camera. Once paired, the speaker acts as an audio out device where you can play audio clips and transmit sound through the camera.

Important

For this feature to work with a video management software (VMS), you must first pair the camera with the network speaker, then add the camera to your VMS.

Address: Enter host name or IP address to the network speaker.

Username: Enter username.

Password: Enter password for the user.

Clear fields: Click to clear all fields.

Connect: Click to establish connection to the network speaker.



I/O ports

Use digital input to connect external devices that can toggle between an open and closed circuit, for example PIR sensors, door or window contacts, and glass break detectors.

Use digital output to connect external devices such as relays and LEDs. You can activate connected devices through the VAPIX® Application Programming Interface or in the device interface.



Port

Name: Edit the text to rename the port.

Direction:  indicates that the port is an input port.  indicates that it's an output port. If the port is configurable, you can click the icons to change between input and output.

AXIS M11-E Mk II Series

The device interface

Normal state: Click  open circuit, and  for closed circuit.

Current state: Shows the current state of the port. The input or output is activated when the current state is different from the normal state. An input on the device has an open circuit when it's disconnected or when there is a voltage above 1 V DC.

Note

During restart the output circuit is open. When the restart is complete, the circuit goes back to the normal position. If you change any settings on this page, the output circuits go back to their normal positions regardless of any active triggers.

Supervised  : Turn on to make it possible to detect and trigger actions if someone tampers with the connection to digital I/O devices. In addition to detecting if an input is open or closed, you can also detect if someone has tampered with it (that is, cut or shorted). To supervise the connection requires additional hardware (end-of-line resistors) in the external I/O loop.

Logs

Reports and logs

Reports

- **View the device server report:** Click to show information about the product status in a pop-up window. The Access Log is automatically included in the Server Report.
- **Download the device server report:** Click to download the server report. It creates a .zip file that contains a complete server report text file in UTF-8 format, as well as a snapshot of the current live view image. Always include the server report .zip file when you contact support.
- **Download the crash report:** Click to download an archive with detailed information about the server's status. The crash report contains information that is in the server report as well as detailed debug information. This report might contain sensitive information such as network traces. It can take several minutes to generate the report.

Logs

- **View the system log:** Click to show information about system events such as device startup, warnings and critical messages.
- **View the access log:** Click to show all failed attempts to access the device, for example when a wrong login password is used.

Network trace

Important

A network trace file might contain sensitive information, for example certificates or passwords.

A network trace file can help you troubleshoot problems by recording activity on the network. Select the duration of the trace in seconds or minutes, and click **Download**.

Remote system log

AXIS M11-E Mk II Series

The device interface

Syslog is a standard for message logging. It allows separation of the software that generates messages, the system that stores them, and the software that reports and analyzes them. Each message is labeled with a facility code, which indicates the software type generating the message, and assigned a severity level.



Server: Click to add a new server.

Host: Enter the hostname or IP address of the server.

Format: Select which syslog message format to use.

- RFC 3164
- RFC 5424

Protocol: Select the protocol and port to use:

- UDP (Default port is 514)
- TCP (Default port is 601)
- TLS (Default port is 6514)

Severity: Select which messages to send when triggered.

CA certificate set: See the current settings or add a certificate.

Plain config

Plain config is for advanced users with experience of Axis device configuration. Most parameters can be set and edited from this page.

Maintenance

Restart: Restart the device. This does not affect any of the current settings. Running applications restart automatically.

Restore: Return *most* settings to the factory default values. Afterwards you must reconfigure the device and apps, reinstall any apps that didn't come preinstalled, and recreate any events and PTZ presets.

Important

The only settings saved after restore are:

- Boot protocol (DHCP or static)
- Static IP address
- Default router
- Subnet mask
- 802.1X settings
- Q3C settings

Factory default: Return *all* settings to the factory default values. Afterwards you must reset the IP address to make the device accessible.

Note

All Axis device firmware is digitally signed to ensure that you only install verified firmware on your device. This further increases the overall minimum cybersecurity level of Axis devices. For more information, see the white paper "Signed firmware, secure boot, and security of private keys" at axis.com.

Firmware upgrade: Upgrade to a new firmware version. New firmware releases can contain improved functionality, bug fixes, and completely new features. We recommend you to always use the latest release. To download the latest release, go to axis.com/support.

AXIS M11-E Mk II Series

The device interface

When you upgrade, you can choose between three options:

- **Standard upgrade:** Upgrade to the new firmware version.
- **Factory default:** Upgrade and return all settings to the factory default values. When you choose this option, you can't revert to the previous firmware version after the upgrade.
- **Autorollback:** Upgrade and confirm the upgrade within the set time. If you don't confirm, the device reverts to the previous firmware version.

Firmware rollback: Revert to the previously installed firmware version.

AXIS M11-E Mk II Series

Learn more

Learn more

Bitrate control

Bitrate control helps you to manage the bandwidth consumption of your video stream.

Variable bitrate (VBR)

Variable bitrate allows the bandwidth consumption to vary depending on the level of activity in the scene. The more activity, the more bandwidth you need. With variable bitrate you are guaranteed constant image quality, but you need to make sure you have storage margins.

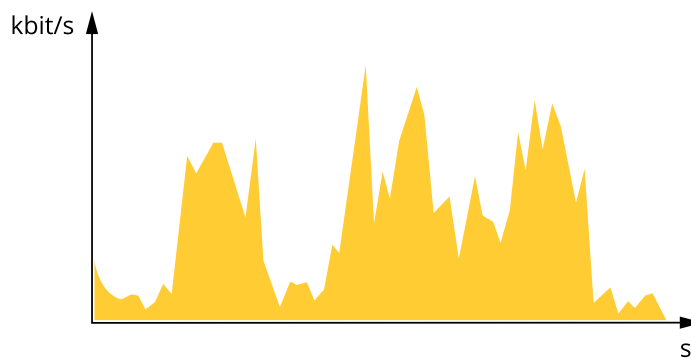

Maximum bitrate (MBR)

Maximum bitrate lets you set a target bitrate to handle bitrate limitations in your system. You might see a decline in image quality or frame rate as the instantaneous bitrate is kept below the specified target bitrate. You can choose to prioritize either image quality or frame rate. We recommend that you configure the target bitrate to a higher value than the expected bitrate. This gives you a margin in case there is a high level of activity in the scene.

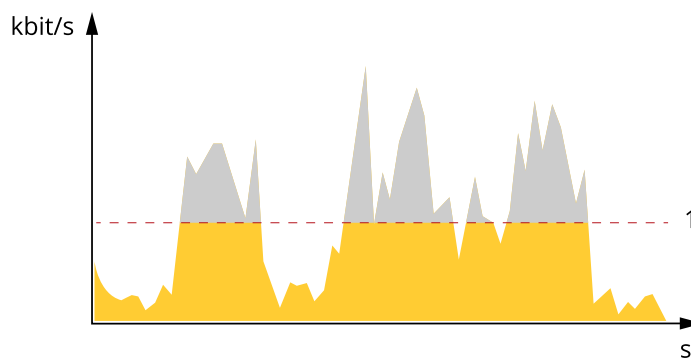

1 Target bitrate

Average bitrate (ABR)

With average bitrate, the bitrate is automatically adjusted over a longer period of time. This is so you can meet the specified target and provide the best video quality based on your available storage. Bitrate is higher in scenes with a lot of activity, compared to static scenes. You are more likely to get better image quality when in scenes with a lot of activity if you use the average bitrate option. You can define the total storage required to store the video stream for a specified amount of time (retention time) when image quality is adjusted to meet the specified target bitrate. Specify the average bitrate settings in one of the following ways:

- To calculate the estimated storage need, set the target bitrate and the retention time.

AXIS M11-E Mk II Series

Learn more

- To calculate the average bitrate, based on available storage and required retention time, use the target bitrate calculator.

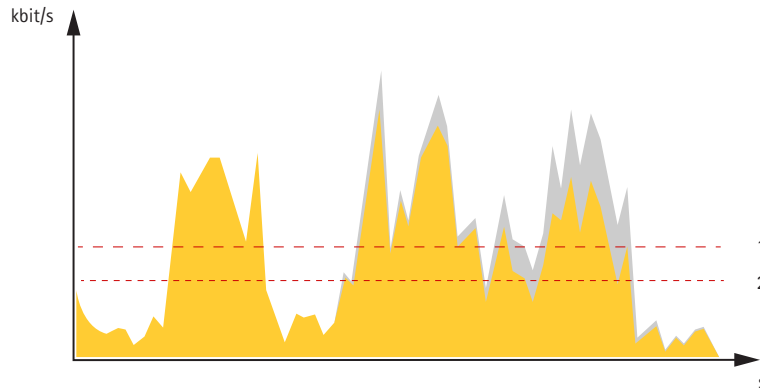

- 1 Target bitrate
- 2 Actual average bitrate

You can also turn on maximum bitrate and specify a target bitrate within the average bitrate option.

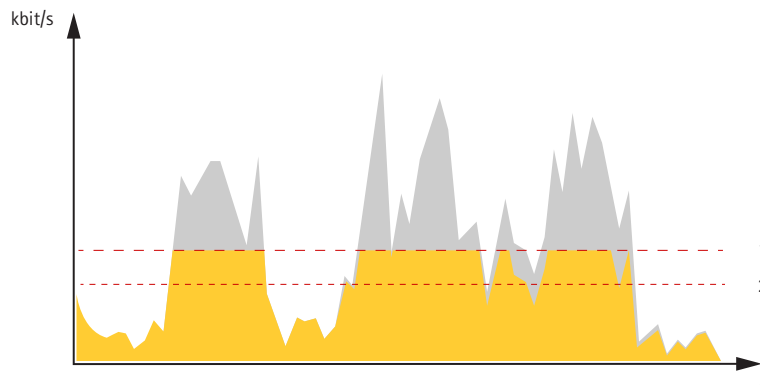

- 1 Target bitrate
- 2 Actual average bitrate

View area

A view area is a cropped part of the full view. You can stream and store view areas instead of the full view to minimize bandwidth and storage needs. If you enable PTZ for a view area, you can pan, tilt and zoom within it. By using view areas you can remove parts of the full view, for example, the sky.

When you set up a view area, we recommend you to set the video stream resolution to the same size as or smaller than the view area size. If you set the video stream resolution larger than the view area size it implies digitally scaled up video after sensor capture, which requires more bandwidth without adding image information.

Privacy masks

A privacy mask is a user-defined area that prevents users from viewing a part of the monitored area. In the video stream, privacy masks appear as blocks of solid color or blurred image elements.

You'll see the privacy mask on all snapshots, recorded video, and live streams.

You can use the VAPIX® application programming interface (API) to turn off the privacy masks.

AXIS M11-E Mk II Series

Learn more

Important

If you use multiple privacy masks it may affect the product's performance.

Overlays

Overlays are superimposed over the video stream. They are used to provide extra information during recordings, such as a timestamp, or during product installation and configuration. You can add either text or an image.

Streaming and storage

Video compression formats

Decide which compression method to use based on your viewing requirements, and on the properties of your network. The available options are:

Motion JPEG

Motion JPEG, or MJPEG, is a digital video sequence that is made up of a series of individual JPEG images. These images are then displayed and updated at a rate sufficient to create a stream that shows constantly updated motion. For the viewer to perceive motion video the rate must be at least 16 image frames per second. Full motion video is perceived at 30 (NTSC) or 25 (PAL) frames per second.

The Motion JPEG stream uses considerable amounts of bandwidth, but provides excellent image quality and access to every image contained in the stream.

H.265 or MPEG-H Part 2/HEVC

H.265 can, without compromising image quality, reduce the size of a digital video file by more than 25% compared to H.264.

Note

- H.265 is licensed technology. The Axis product includes one H.265 viewing client license. Installing additional unlicensed copies of the client is prohibited. To purchase additional licenses, contact your Axis reseller.
- Most web browsers don't support H.265 decoding and because of this the camera doesn't support it in its web interface. Instead you can use a video management system or application supporting H.265 decoding.

How do Image, Stream, and Stream profile settings relate to each other?

The **Image** tab contains camera settings that affect all video streams from the product. If you change something in this tab, it immediately affects all video streams and recordings.

The **Stream** tab contains settings for video streams. You get these settings if you request a video stream from the product and don't specify for example resolution, or frame rate. When you change the settings in the **Stream** tab, it doesn't affect ongoing streams, but it will take effect when you start a new stream.

The **Stream profiles** settings override the settings from the **Stream** tab. If you request a stream with a specific stream profile, the stream contains the settings of that profile. If you request a stream without specifying a stream profile, or request a stream profile that doesn't exist in the product, the stream contains the settings from the **Stream** tab.

Applications

AXIS Camera Application Platform (ACAP) is an open platform that enables third parties to develop analytics and other applications for Axis products. To find out more about available applications, downloads, trials and licenses, go to axis.com/applications.

To find the user manuals for Axis applications, go to help.axis.com.

Note

- Several applications can run at the same time but some applications might not be compatible with each other. Certain combinations of applications might require too much processing power or memory resources when run in parallel. Verify that the applications work together before deployment.

AXIS M11-E Mk II Series

Learn more



To watch this video, go to the web version of this document.

www.axis.com/products/online-manual/#t10001688

How to download and install an application



To watch this video, go to the web version of this document.

www.axis.com/products/online-manual/#t10001688

How to activate an application licence code on a device

AXIS M11-E Mk II Series

Specifications

Specifications

Product overview

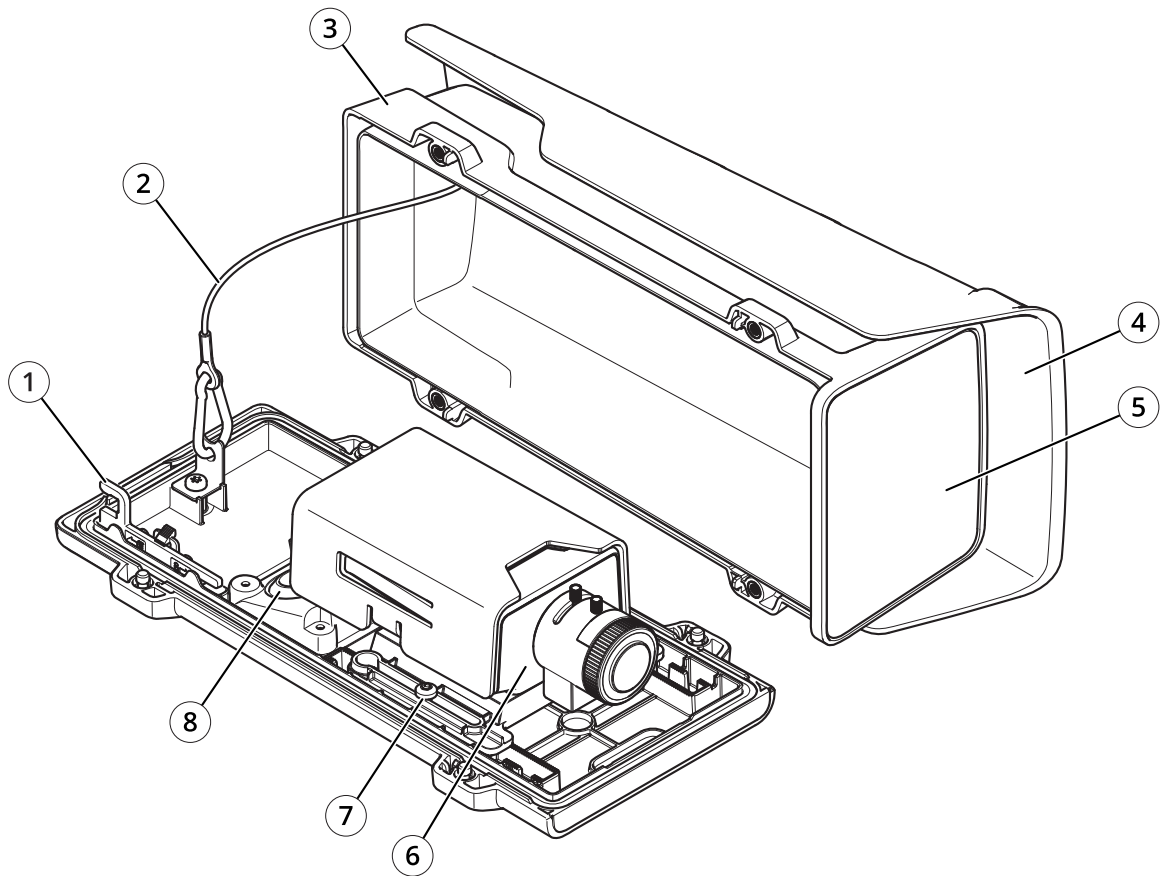

- 1 IK10 tool
- 2 Safety wire
- 3 Top cover
- 4 Weather cover
- 5 Front window
- 6 Network camera
- 7 Holder screw (2x)
- 8 Cable gasket (2x)

AXIS M11-E Mk II Series

Specifications

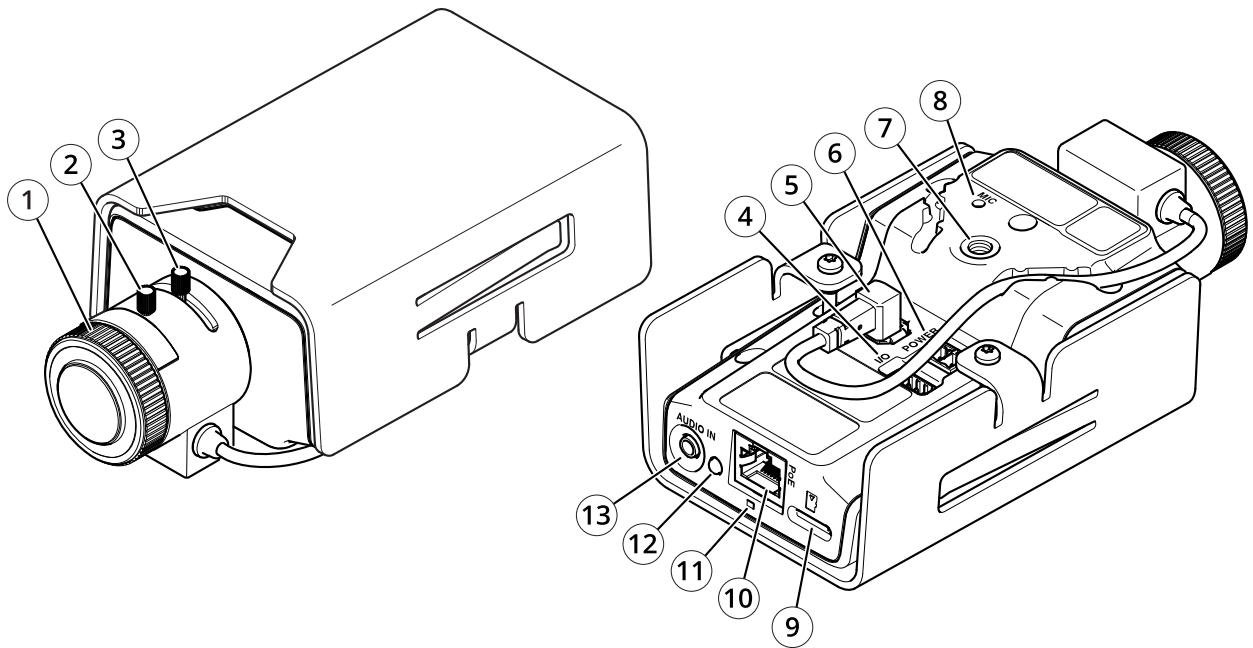

- 1 Focus ring
- 2 Focus ring lock
- 3 Zoom puller
- 4 I/O connector
- 5 Iris connector
- 6 Power connector
- 7 1/4" Screw mount
- 8 Microphone
- 9 microSD card slot
- 10 Network connector, PoE
- 11 LED
- 12 Control button
- 13 Audio in

LED indicators

Note

The Status LED can be configured to flash while an event is active.

Status LED	Indication
Unlit	Connection and normal operation.
Green	Shows steady green for 10 seconds for normal operation after startup completed.
Amber	Steady during startup. Flashes during firmware upgrade or reset to factory default.
Amber/Red	Flashes amber/red if network connection is unavailable or lost.

AXIS M11-E Mk II Series

Specifications

SD card slot

NOTICE

- Risk of damage to SD card. Do not use sharp tools, metal objects, or excessive force when inserting or removing the SD card. Use your fingers to insert and remove the card.
- Risk of data loss and corrupted recordings. Do not remove the SD card while the product is running. Unmount the SD card from the product's webpage before removal.

This product supports microSD/microSDHC/microSDXC cards.

For SD card recommendations, see axis.com.



microSD, microSDHC, and microSDXC Logos are trademarks of SD-3C LLC. microSD, microSDHC, microSDXC are trademarks or registered trademarks of SD-3C, LLC in the United States, other countries or both.

Buttons

Control button

The control button is used for:

- Resetting the product to factory default settings. See *Reset to factory default settings on page 53*.

Connectors

Network connector

RJ45 Ethernet connector with Power over Ethernet (PoE).

Audio connector

- Audio in – 3.5 mm input for a mono microphone, or a line-in mono signal (left channel is used from a stereo signal).



Audio input

1 Tip	2 Ring	3 Sleeve
-------	--------	----------

I/O connector

Use the I/O connector with external devices in combination with, for example, motion detection, event triggering, and alarm notifications. In addition to the 0 V DC reference point and power (DC output), the I/O connector provides the interface to:

Digital input – For connecting devices that can toggle between an open and closed circuit, for example PIR sensors, door/window contacts, and glass break detectors.

Digital output – For connecting external devices such as relays and LEDs. Connected devices can be activated by the VAPIX® Application Programming Interface, through an event or from the product's webpage.

Note

The I/O connector is connected to the housing (fan/heater) on delivery. In case of a fan or heater error, an input signal will be triggered in the camera. Set up an action rule in the camera to configure which action the signal shall trigger.

AXIS M11-E Mk II Series

Specifications

4-pin terminal block

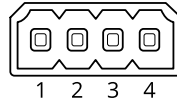

Function	Pin	Notes	Specifications
DC ground	1		0 V DC
DC output	2	Can be used to power auxiliary equipment. Note: This pin can only be used as power out.	12 V DC Max load = 25 mA
Digital Input	3	Connect to pin 1 to activate, or leave floating (unconnected) to deactivate.	0 to max 30 V DC
Digital Output	4	Internally connected to pin 1 (DC ground) when active, and floating (unconnected) when inactive. If used with an inductive load, e.g., a relay, connect a diode in parallel with the load, to protect against voltage transients.	0 to max 30 V DC, open drain, 100 mA

Example

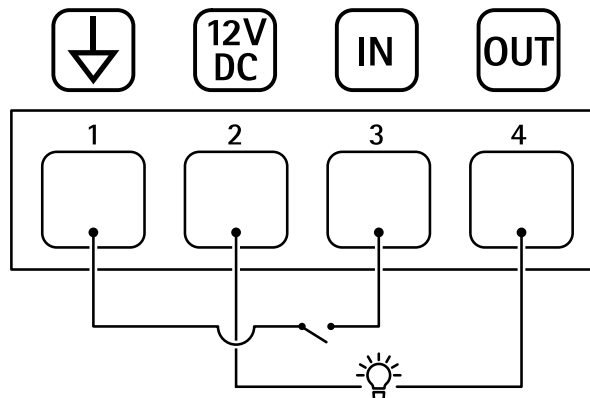

- 1 DC ground
- 2 DC output 12 V, max 25 mA
- 3 Digital input
- 4 Digital output

Power connector

2-pin terminal block for DC power input. Use a Safety Extra Low Voltage (SELV) compliant limited power source (LPS) with either a rated output power limited to ≤ 100 W or a rated output current limited to ≤ 5 A.

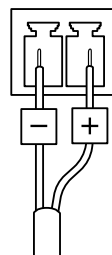

AXIS M11-E Mk II Series

Troubleshooting

Troubleshooting

Reset to factory default settings

Important

Reset to factory default should be used with caution. A reset to factory default resets all settings, including the IP address, to the factory default values.

To reset the product to the factory default settings:

1. Disconnect power from the product.
2. Press and hold the control button while reconnecting power. See *Product overview on page 49*.
3. Keep the control button pressed for 15–30 seconds until the status LED indicator flashes amber.
4. Release the control button. The process is complete when the status LED indicator turns green. The product has been reset to the factory default settings. If no DHCP server is available on the network, the default IP address is 192.168.0.90.
5. Use the installation and management software tools to assign an IP address, set the password, and access the device.

The installation and management software tools are available from the support pages on axis.com/support.

You can also reset parameters to factory default through the device's webpage. Go to **Maintenance > Factory default** and click **Default**.

Firmware options

Axis offers product firmware management according to either the active track or the long-term support (LTS) tracks. Being on the active track means continuously getting access to all the latest product features, while the LTS tracks provide a fixed platform with periodic releases focused mainly on bug fixes and security updates.

Using firmware from the active track is recommended if you want to access the newest features, or if you use Axis end-to-end system offerings. The LTS tracks are recommended if you use third-party integrations, which are not continuously validated against the latest active track. With LTS, the products can maintain cybersecurity without introducing any significant functional changes or affecting any existing integrations. For more detailed information about Axis product firmware strategy, go to axis.com/support/firmware.

Check the current firmware version

Firmware is the software that determines the functionality of network devices. When you troubleshoot a problem, we recommend you to start by checking the current firmware version. The latest firmware version might contain a correction that fixes your particular problem.

To check the current firmware:

1. Go to the device interface > **Status**.
2. See the firmware version under **Device info**.

Upgrade the firmware

Important

Preconfigured and customized settings are saved when you upgrade the firmware (provided that the features are available in the new firmware) although this is not guaranteed by Axis Communications AB.

Important

Make sure the device remains connected to the power source throughout the upgrade process.

AXIS M11-E Mk II Series

Troubleshooting

Note

When you upgrade the device with the latest firmware in the active track, the product receives the latest functionality available. Always read the upgrade instructions and release notes available with each new release before you upgrade the firmware. To find the latest firmware and the release notes, go to axis.com/support/firmware.

1. Download the firmware file to your computer, available free of charge at axis.com/support/firmware.
2. Log in to the device as an administrator.
3. Go to **Maintenance > Firmware upgrade** and click **Upgrade**.

When the upgrade has finished, the product restarts automatically.

You can use AXIS Device Manager to upgrade multiple devices at the same time. Find out more at axis.com/products/axis-device-manager.

Technical issues, clues, and solutions

If you can't find what you're looking for here, try the troubleshooting section at axis.com/support.

Problems upgrading the firmware

Firmware upgrade failure	If the firmware upgrade fails, the device reloads the previous firmware. The most common reason is that the wrong firmware file has been uploaded. Check that the name of the firmware file corresponds to your device and try again.
Problems after firmware upgrade	If you experience problems after a firmware upgrade, roll back to the previously installed version from the Maintenance page.

Problems setting the IP address

The device is located on a different subnet	If the IP address intended for the device and the IP address of the computer used to access the device are located on different subnets, you cannot set the IP address. Contact your network administrator to obtain an IP address.
The IP address is being used by another device	Disconnect the Axis device from the network. Run the ping command (in a Command/DOS window, type <code>ping</code> and the IP address of the device): <ul style="list-style-type: none">• If you receive: <code>Reply from <IP address>: bytes=32; time=10...</code> this means that the IP address may already be in use by another device on the network. Obtain a new IP address from the network administrator and reinstall the device.• If you receive: <code>Request timed out</code>, this means that the IP address is available for use with the Axis device. Check all cabling and reinstall the device.
Possible IP address conflict with another device on the same subnet	The static IP address in the Axis device is used before the DHCP server sets a dynamic address. This means that if the same default static IP address is also used by another device, there may be problems accessing the device.

The device can't be accessed from a browser

Can't log in	When HTTPS is enabled, ensure that the correct protocol (HTTP or HTTPS) is used when attempting to log in. You may need to manually type <code>http</code> or <code>https</code> in the browser's address field. If the password for the user <code>root</code> is lost, the device must be reset to the factory default settings. See <i>Reset to factory default settings on page 53</i> .
--------------	---

AXIS M11-E Mk II Series

Troubleshooting

The IP address has been changed by DHCP	IP addresses obtained from a DHCP server are dynamic and may change. If the IP address has been changed, use AXIS IP Utility or AXIS Device Manager to locate the device on the network. Identify the device using its model or serial number, or by the DNS name (if the name has been configured). If required, a static IP address can be assigned manually. For instructions, go to axis.com/support .
Certificate error when using IEEE 802.1X	For authentication to work properly, the date and time settings in the Axis device must be synchronized with an NTP server. Go to System > Date and time .

The device is accessible locally but not externally

To access the device externally, we recommend you to use one of the following applications for Windows®:

- AXIS Companion: free of charge, ideal for small systems with basic surveillance needs.
- AXIS Camera Station: 30-day trial version free of charge, ideal for small to mid-size systems.

For instructions and download, go to axis.com/vms.

Problems with streaming

Multicast H.264 only accessible by local clients	Check if your router supports multicasting, or if you need to configure the router settings between the client and the device. You might need to increase the TTL (Time To Live) value.
No multicast H.264 displayed in the client	Check with your network administrator that the multicast addresses used by the Axis device are valid for your network. Check with your network administrator to see if there is a firewall that prevents viewing.
Poor rendering of H.264 images	Ensure that your graphics card uses the latest driver. You can usually download the latest drivers from the manufacturer's website.
Color saturation is different in H.264 and Motion JPEG	Modify the settings for your graphics adapter. Go to the adapter's documentation for more information.
Lower frame rate than expected	<ul style="list-style-type: none">• See <i>Performance considerations on page 55</i>.• Reduce the number of applications running on the client computer.• Limit the number of simultaneous viewers.• Check with the network administrator that there is enough bandwidth available.• Lower the image resolution.
Can't select H.265 encoding in live view	Web browsers don't support H.265 decoding. Use a video management system or application that supports H.265 decoding.

Performance considerations

When setting up your system, it is important to consider how various settings and situations affect the performance. Some factors affect the amount of bandwidth (the bitrate) required, others can affect the frame rate, and some affect both. If the load on the CPU reaches its maximum, this also affects the frame rate.

The following factors are the most important to consider:

- High image resolution or lower compression levels result in images containing more data which in turn affects the bandwidth.
- Rotating the image in the GUI will increase the product's CPU load.
- Access by large numbers of Motion JPEG or unicast H.264 clients affects the bandwidth.
- Access by large numbers of Motion JPEG or unicast H.265 clients affects the bandwidth.
- Simultaneous viewing of different streams (resolution, compression) by different clients affects both frame rate and bandwidth.

AXIS M11-E Mk II Series

Troubleshooting

Use identical streams wherever possible to maintain a high frame rate. Stream profiles can be used to ensure that streams are identical.

- Accessing Motion JPEG and H.264 video streams simultaneously affects both frame rate and bandwidth.
- Accessing Motion JPEG and H.265 video streams simultaneously affects both frame rate and bandwidth.
- Heavy usage of event settings affects the product's CPU load which in turn affects the frame rate.
- Using HTTPS may reduce frame rate, in particular if streaming Motion JPEG.
- Heavy network utilization due to poor infrastructure affects the bandwidth.
- Viewing on poorly performing client computers lowers perceived performance and affects frame rate.
- Running multiple AXIS Camera Application Platform (ACAP) applications simultaneously may affect the frame rate and the general performance.

Need more help?

Useful links

- *How to assign an IP address and access your device*

Contact support

Contact support at axis.com/support.

