

AXIS M30 Network Camera Series

AXIS M3067-P Network Camera

AXIS M3068-P Network Camera

AXIS M30 Network Camera Series

Installation

Installation



To watch this video, go to the web version of this document.

www.axis.com/products/online-manual/49037#t10170651

Installation video for the product.

AXIS M30 Network Camera Series

Table of Contents

Installation	2
Get started	4
Find the device on the network	4
Access the device	4
Webpage overview	6
Additional settings	8
Adjust the image	8
View and record video	12
Set up rules and alerts	13
Cleaning recommendations	16
Learn more	17
Privacy masks	17
Overlays	17
Pan, tilt, and zoom (PTZ)	17
Streaming and storage	17
Applications	20
Troubleshooting	22
Reset to factory default settings	22
Firmware options	22
Check the current firmware	22
Upgrade the firmware	22
Technical issues, clues and solutions	23
Performance considerations	25
Contact support	25
Specifications	26
Product overview	26
LED indicators	26
SD card slot	27
Buttons	27
Connectors	27

AXIS M30 Network Camera Series

Get started

Get started

Find the device on the network

To find Axis devices on the network and assign them IP addresses in Windows®, use AXIS IP Utility or AXIS Device Manager. Both applications are free and can be downloaded from axis.com/support.

For more information about how to find and assign IP addresses, go to *How to assign an IP address and access your device*.

Browser support

You can use the device with the following browsers:

	Chrome™	Firefox®	Edge™	Safari®
Windows®	recommended	recommended	x	
macOS®	recommended	recommended	x	x
Linux®	recommended	recommended	x	
Other operating systems	x	x	x	x*

*Supported in iOS and iPadOS

If you need more information about recommended browsers, go to *AXIS OS Portal*.

Access the device

1. Open a browser and enter the IP address or host name of the Axis device.
If you do not know the IP address, use AXIS IP Utility or AXIS Device Manager to find the device on the network.
2. Enter the username and password. If you access the device for the first time, you must set the root password. See *Set a new password for the root account on page 4*.
3. The live view page opens in your browser.

Verify that no one has tampered with the firmware

To make sure that the device has its original Axis firmware, or to take full control of the device after a security attack:

1. Reset to factory default settings. See *Reset to factory default settings on page 22*.
After the reset, secure boot guarantees the state of the device.
2. Configure and install the device.

Set a new password for the root account

Important

The default administrator username is **root**. If the password for root is lost, reset the device to factory default settings. See *Reset to factory default settings on page 22*

AXIS M30 Network Camera Series

Get started



To watch this video, go to the web version of this document.

www.axis.com/products/online-manual/49037#t10098905

Support tip: Password security confirmation check

1. Type a password. Follow the instructions about secure passwords. See *Secure passwords on page 5*.
2. Retype the password to confirm the spelling.
3. Click **Create login**. The password has now been configured.

Secure passwords

Important

Axis devices send the initially set password in clear text over the network. To protect your device after the first login, set up a secure and encrypted HTTPS connection and then change the password.

The device password is the primary protection for your data and services. Axis devices do not impose a password policy as they may be used in various types of installations.

To protect your data we strongly recommend that you:

- Use a password with at least 8 characters, preferably created by a password generator.
- Don't expose the password.
- Change the password at a recurring interval, at least once a year.

AXIS M30 Network Camera Series

Get started

Webpage overview



- 1 *Live view control bar*
- 2 *Live view*
- 3 *Product name*
- 4 *User information, color themes, and help*
- 5 *Video control bar*
- 6 *Settings toggle*

AXIS M30 Network Camera Series

Get started

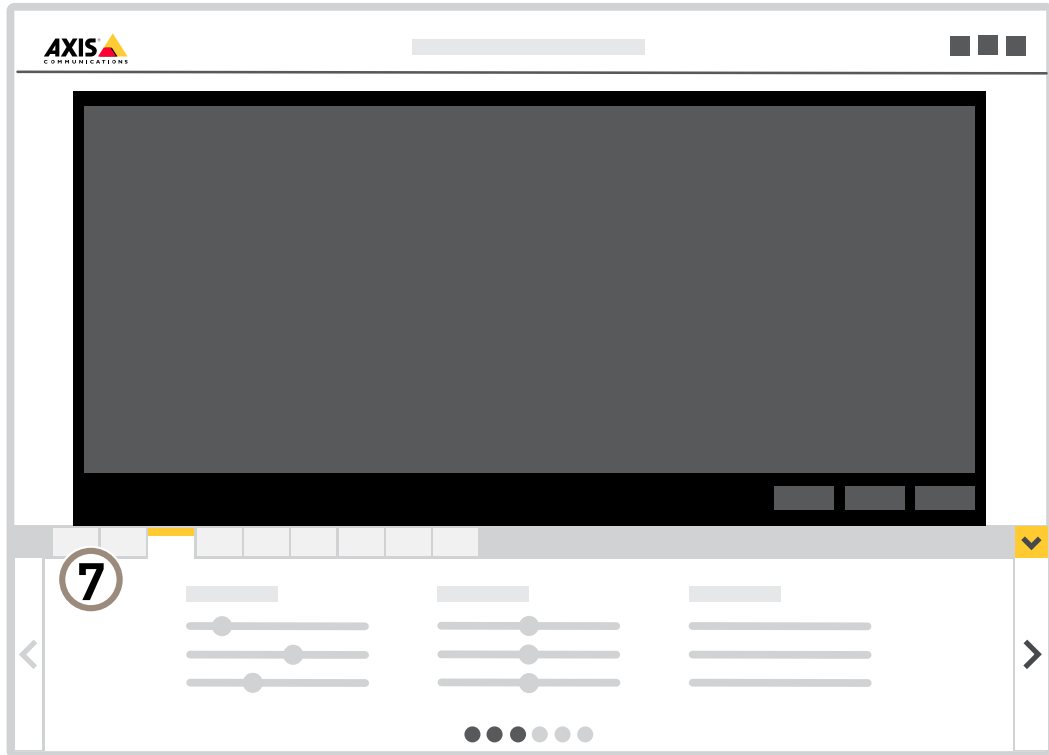

7 Settings tabs

AXIS M30 Network Camera Series

Additional settings

Additional settings

Adjust the image

This section includes instructions about how to configure your device. If you want to learn more about how certain features function, go to *Learn more on page 17*.

Rotate the image with digital roll

Note

If you rotate the image, all views will be affected.

To rotate the 360° view, go to **System > Orientation** and use the slider.

You can also use the text field to change the roll angle.

Configure the quad view

Note

Quad view is available in these mounting positions:

- Desk
- Ceiling





1. Select **Quad view** among the live feed sources.
2. Go to **Settings > System > Orientation** and click .
3. To change the view order, drag and drop the yellow boxes.

About capture modes

This product has several possible views defined as capture modes. You can access all capture modes from the drop-down list in the product's live stream view.

Note





If you select capture mode "360° overview only @ 60/50 fps no WDR" on AXIS M3067-P or capture mode "360° overview only @ 30/25 fps no WDR" on AXIS M3068-P, you will only have Overview as an option. For other capture modes, see the table for supported views and resolutions.

View	Symbol	Aspect ratio	Resolutions for AXIS M3067-P	Resolutions for AXIS M3068-P
Overview		1:1	2016x2016 to 160x160	2880x2880 to 160x160
Panorama		8:3 16:9 32:9	2560x960 to 192x72 2560x1440 to 256x144 2560x720 to 1280x360	3584x1344 to 192x72 3840x2160 to 256x144 3584x1008 to 128x360
Double Panorama		4:3 16:9	2560x1920 to 256x192 2560x1440 to 512x288	3584x2668 to 384x288 3584x2016 to 512x288
Quad View		4:3 16:9	2560x1920 to 256x192 2560x1440 to 512x288	3584x2668 to 384x288 3584x2016 to 512x288

AXIS M30 Network Camera Series

Additional settings

(Continued)

View Areas 1-4		4:3 16:9	1920x1440 to 320x240 1920x1080 to 256x144	2048x1536 to 320x240 2048x1152 to 256x144
Corner Left/Right		8:3 2:1	2304x864 to 192x72 2368x1184	3200x1200 to 192x72 3200x1600 to 2400x1200
Double Corner		4:3 1:1	1920x1440 to 256x192 2016x2016 to 480x480	2560x1920 to 384x288 2880x2880 to 480x480
Corridor		4:3 16:9	2560x1920 to 320x240 2560x1440 to 256x144	2560x1920 to 320x240 2560x1440 to 256x144

Select exposure mode

There are different exposure mode options in the camera that adjusts aperture, shutter speed, and gain to improve image quality for specific surveillance scenes. Go to **Settings > Image > Exposure** and select between the following exposure modes:

- For most use cases, select **Automatic** exposure.
- For environments with certain artificial lighting, for example fluorescent lighting, select **Flicker-free**.
Select the same frequency as the power line frequency.
- For environments with certain artificial light and bright light, for example outdoors with fluorescent lighting at night and sun during daytime, select **Flicker-reduced**.
Select the same frequency as the power line frequency.
- To lock the current exposure settings, select **Hold current**.

Reduce noise in low-light conditions

To reduce noise in low-light conditions, you can adjust one or more of the following settings:

- Adjust the trade-off between noise and motion blur. Go to **Settings > Image > Exposure** and move the **Blur-noise trade-off** slider toward **Low noise**.
- Set the exposure mode to automatic.

Note

A high max shutter value can result in motion blur.

- To slow down the shutter speed, set max shutter to the highest possible value.
- Reduce sharpness in the image.
- Open the aperture.

Reduce motion blur in low-light conditions

To reduce motion blur in low-light conditions, adjust one or more of the following settings in **Settings > Image > Exposure**:

- Move the **Blur-noise trade-off** slider toward **Low motion blur**.

Note

When you increase the gain, image noise also increases.

AXIS M30 Network Camera Series

Additional settings

- Set **Max shutter** to a shorter time, and **Max gain** to a higher value.

If you still have problems with motion blur:

- Increase the light level in the scene.
- Mount the camera so that objects move toward it or away from it rather than sideways.

Maximize the details in an image

Important

If you maximize the details in an image, the bitrate will probably increase and you might get a reduced frame rate.

- Set the compression as low as possible.
- Select MJPEG streaming.
- Turn off Zipstream functionality.

Handle scenes with strong backlight

Dynamic range is the difference in light levels in an image. In some cases the difference between the darkest and the brightest areas can be significant. The result is often an image where either the dark or the bright areas are visible. Wide dynamic range (WDR) makes both dark and bright areas of the image visible.



Image without WDR.



Image with WDR.

Note

- WDR can cause artifacts in the image.
 - WDR may not be available for all capture modes.
1. Go to **Settings > Image > Wide dynamic range**.

AXIS M30 Network Camera Series

Additional settings

2. Turn on WDR.
3. If you still have problems, go to **Exposure** and adjust the **Exposure zone** to cover the area of interest.

Find out more about WDR and how to use it at axis.com/web-articles/wdr.

Hide parts of the image with privacy masks

You can create one or several privacy masks to hide parts of the image.



How to create a privacy mask

1. Go to **Settings > Privacy mask**.
2. Click **New**.
3. Adjust the size, color, and name of the privacy mask according to your needs.



How to change the appearance of the mask

Show an image overlay

You can add an image as an overlay in the video stream.

1. Go to **Settings > Overlay**.
2. Click **Image list**.
3. Upload an image and click **Done**.
4. Click **Create overlay**.
5. Select **Image** and click **Create**.
6. Select the image from the drop-down list.

AXIS M30 Network Camera Series

Additional settings

7. To position the image overlay, choose **Custom** or one of the presets.
8. Click **Create**.

Show the pan or tilt position as a text overlay

You can show the pan or tilt position as an overlay in the image.

1. Go to **Settings > Overlay** and click **Create overlay**.
2. Select **Text** and click **Create**.
3. In the text field, type #x to show the pan position.
Type #y to show the tilt position.
4. Choose appearance, text size, and alignment.
5. **Include** the text overlay.
6. The current pan and tilt positions show up in the live view image and in the recording.

View and record video

This section includes instructions about how to configure your device. To learn more about how streaming and storage works, go to *Streaming and storage on page 17*.

Reduce bandwidth and storage

Important

If you reduce the bandwidth it can result in loss of details in the picture.

1. Go to live view and select **H.264**.
2. Go to **Settings > Stream**.
3. Do one or more of the following:

Note

The zipstream settings are used for both H.264 and H.265.

- Turn on dynamic GOP and set a high GOP length value.
- Increase the compression.
- Turn on dynamic FPS.

Note

Web browsers do not support H.265 decoding. Use a video management system or application supporting H.265 decoding.

Set up network storage

To store recordings on the network, you need to set up your network storage.

1. Go to **Settings > System > Storage**.
2. Click **Setup** under **Network storage**.
3. Enter the IP address of the host server.
4. Enter the name of the shared location on the host server.

AXIS M30 Network Camera Series

Additional settings

5. Move the switch if the share requires a login, and enter username and password.
6. Click Connect.

Record and watch video

To record video you must first set up network storage, see *Set up network storage on page 12*, or have an SD card installed.

Record video

1. Go to the live view.
2. To start a recording, click **Record**. Click again to stop the recording.

Watch video

1. Click **Storage > Go to recordings**.
2. Select your recording in the list and it will play automatically.

Set up rules and alerts

You can create rules to make your device perform an action when certain events occur. A rule consists of conditions and actions. The conditions can be used to trigger the actions. For example, the device can start a recording or send an email when it detects motion, or show an overlay text while the device is recording.

Trigger an action

1. Go to **Settings > System > Events** to set up a rule. The rule defines when the device will perform certain actions. Rules can be setup as scheduled, recurring, or for example, triggered by motion detection.
2. Select the **Condition** that must be met to trigger the action. If you specify more than one condition for the rule, all of the conditions must be met to trigger the action.
3. Select which **Action** the device should perform when the conditions are met.

Note

If you make changes to an active rule, you have to restart the rule for the changes to take effect.

Record video when the camera detects motion

This example explains how to set up the camera to start recording to the SD card five seconds before it detects motion and to stop one minute after.



To watch this video, go to the web version of this document.

www.axis.com/products/online-manual/49037#t10106619

How to record a video stream when the camera detects motion

Make sure that AXIS Video Motion Detection is running:

AXIS M30 Network Camera Series

Additional settings

1. Go to **Settings > Apps > AXIS Video Motion Detection**.
2. Start the application if it is not already running.
3. Make sure you have set up the application according to your needs. If you need help, see the *user manual for AXIS Video Motion Detection 4*.

Create a rule:

1. Go to **Settings > System > Events** and add a rule.
2. Type a name for the rule.
3. In the list of conditions, under **Application**, select **AXIS Video Motion Detection (VMD)**.
4. In the list of actions, under **Recordings**, select **Record video while the rule is active**.
5. Select an existing stream profile or create a new one.
6. Set the prebuffer time to 5 seconds.
7. Set the postbuffer time to 60 seconds.
8. In the list of storage options, select **SD card**.
9. Click **Save**.

Show a text overlay in the video stream when the device detects motion

This example explains how to display the text "Motion detected" when the device detects motion.



How to show text overlay when the camera detects motion

Make sure that AXIS Video Motion Detection is running:

1. Go to **Settings > Apps > AXIS Video Motion Detection**.
2. Start the application if it is not already running.
3. Make sure you have set up the application according to your needs.

Add the overlay text:

4. Go to **Settings > Overlay**.
5. Enter #D in the text field.
6. Choose text size and appearance.

Create a rule:

AXIS M30 Network Camera Series

Additional settings

7. Go to **System > Events > Rules** and add a rule.
8. Type a name for the rule.
9. In the list of conditions, select **AXIS Video Motion Detection**.
10. In the list of actions, select **Use overlay text**.
11. Select a view area.
12. Type "Motion detected".
13. Set the duration.
14. Click **Save**.

Send an email automatically if someone spray paints the lens



To watch this video, go to the web version of this document.



www.axis.com/products/online-manual/49037#t10106687

How to send an email notification if someone spray paint the lens

1. Go to **Settings > System > Detectors**.
2. Turn on **Trigger on dark images**. This will trigger an alarm if the lens is sprayed, covered, or rendered severely out of focus.
3. Set a duration for **Trigger after**. The value indicates the time that must pass before an email is sent.

Create a rule:

1. Go to **Settings > System > Events > Rules** and add a rule.
2. Type a name for the rule.
3. In the list of conditions, select **Tampering**.
4. In the list of actions, select **Send notification to email**.
5. Select a recipient from the list or go to **Recipients** to create a new recipient.

To create a new recipient, click  . To copy an existing recipient, click  .

6. Type a subject and a message for the email.
7. Click **Save**.

AXIS M30 Network Camera Series

Cleaning recommendations

Cleaning recommendations

NOTICE

Never use harsh detergent, for example gasoline, benzene, or acetone.

1. Use a can of compressed air to remove any dust or loose dirt from the device.
2. If necessary, clean the lens with a soft cloth dampened with lukewarm water.

Note

Avoid cleaning in direct sunlight or at elevated temperatures, as this may cause stains when the water droplets dry.

AXIS M30 Network Camera Series

Learn more

Learn more

Privacy masks

A privacy mask is a user-defined area that prevents users from viewing a part of the monitored area. In the video stream, privacy masks appear as blocks of solid color.

You'll see the privacy mask on all snapshots, recorded video, and live streams.

You can use the VAPIX® application programming interface (API) to turn off the privacy masks.

Important

If you use multiple privacy masks it may affect the product's performance.

Note

Privacy masks may appear warped in some view modes.

Overlays

Overlays are superimposed over the video stream. They are used to provide extra information during recordings, such as a timestamp, or during product installation and configuration. You can add either text or an image.

Pan, tilt, and zoom (PTZ)

Note

The PTZ functionality is only available in the dewarped views: Digital PTZ of view areas, digital PTZ of panorama, corner, corridor and quad views.

Guard tours

A guard tour displays the video stream from different preset positions either in a predetermined or random order, and for configurable periods of time. Once started, a guard tour continues to run until stopped, even when there are no clients (web browsers) viewing the images.

Streaming and storage

Video compression formats

Decide which compression method to use based on your viewing requirements, and on the properties of your network. The available options are:

Motion JPEG

Motion JPEG, or MJPEG, is a digital video sequence that is made up of a series of individual JPEG images. These images are then displayed and updated at a rate sufficient to create a stream that shows constantly updated motion. For the viewer to perceive motion video the rate must be at least 16 image frames per second. Full motion video is perceived at 30 (NTSC) or 25 (PAL) frames per second.

The Motion JPEG stream uses considerable amounts of bandwidth, but provides excellent image quality and access to every image contained in the stream.

H.264 or MPEG-4 Part 10/AVC

Note

H.264 is a licensed technology. The Axis product includes one H.264 viewing client license. To install additional unlicensed copies of the client is prohibited. To purchase additional licenses, contact your Axis reseller.

AXIS M30 Network Camera Series

Learn more

H.264 can, without compromising image quality, reduce the size of a digital video file by more than 80% compared to the Motion JPEG format and by as much as 50% compared to the MPEG-4 standard. This means that less network bandwidth and storage space are required for a video file. Or seen another way, higher video quality can be achieved for a given bitrate.

H.265 or MPEG-H Part 2/HEVC

Note

H.265 is licensed technology. The Axis product includes one H.265 viewing client license. To install additional unlicensed copies of the client is prohibited. To purchase additional licenses, contact your Axis reseller.

How do Image, Stream, and Stream profile settings relate to each other?

The **Image** tab contains camera settings that affect all video streams from the product. If you change something in this tab, it immediately affects all video streams and recordings.

The **Stream** tab contains settings for video streams. You get these settings if you request a video stream from the product and don't specify for example resolution, or frame rate. When you change the settings in the **Stream** tab, it doesn't affect ongoing streams, but it will take effect when you start a new stream.

The **Stream profiles** settings override the settings from the **Stream** tab. If you request a stream with a specific stream profile, the stream contains the settings of that profile. If you request a stream without specifying a stream profile, or request a stream profile that doesn't exist in the product, the stream contains the settings from the **Stream** tab.

Note

When you add a new stream profile for a fisheye camera, make sure that the format and resolution are supported for the selected view, see *About capture modes on page 8*.

Bitrate control

With bitrate control, you can manage the bandwidth consumption of your video stream.

Variable bitrate (VBR)

With variable bitrate, the bandwidth consumption varies based on the level of activity in the scene. The more activity in the scene, the more bandwidth you need. You are guaranteed constant image quality but it requires storage margins.

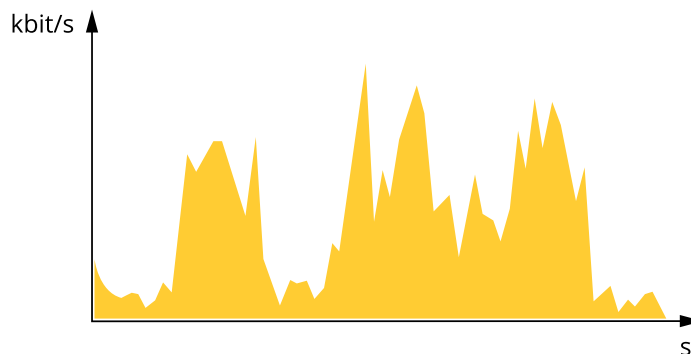

Maximum bitrate (MBR)

With maximum bitrate, you can set a target bitrate to handle bitrate limitations in your system. You may see a decline in image quality or frame rate when the instantaneous bitrate is kept below the specified target bitrate. You can choose to either prioritize image quality or frame rate. We recommend that you configure the target bitrate to a higher value than the expected bitrate. This gives you a margin for additional complexity that needs to be captured.

AXIS M30 Network Camera Series

Learn more

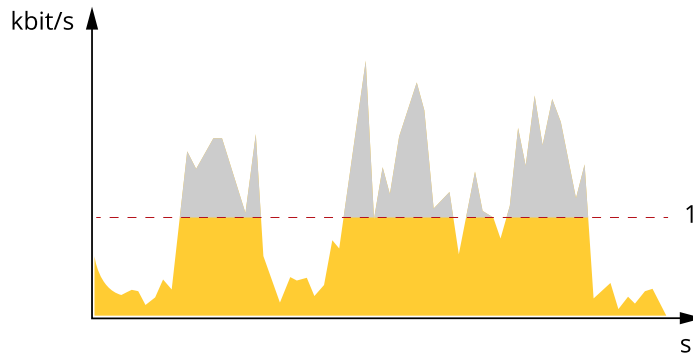

1 Target bitrate

Average bitrate (ABR)

With average bitrate, the bitrate is automatically adjusted over a longer timescale. This is so you can meet the specified target and provide the best video quality based on your available storage. Bitrate is higher in scenes with a lot of activity, compared to static scenes. You are more likely to get better image quality when needed when using the average bitrate option. You can define the total storage required to store the video stream for a specified amount of time (retention time) when image quality is adjusted to meet the specified target bitrate. Specify the average bitrate settings in one of the following ways:

- To calculate the estimated storage need, set the target bitrate and the retention time.
- To calculate the average bitrate, based on available storage and required retention time, use the target bitrate calculator.

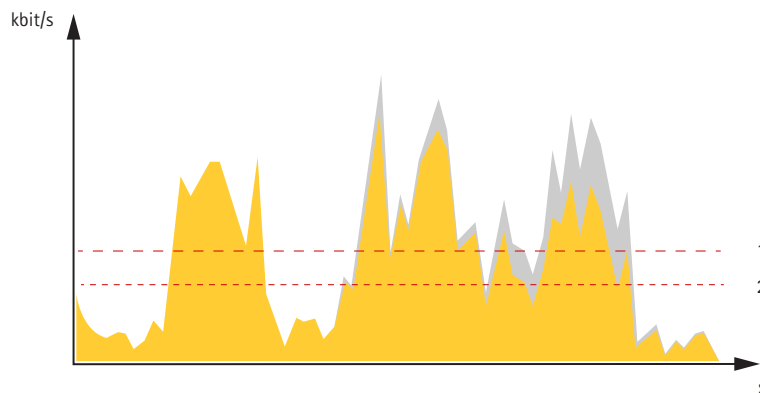

1 Target bitrate
2 Actual average bitrate

You can also turn on maximum bitrate and specify a target bitrate within the average bitrate option.

AXIS M30 Network Camera Series

Learn more

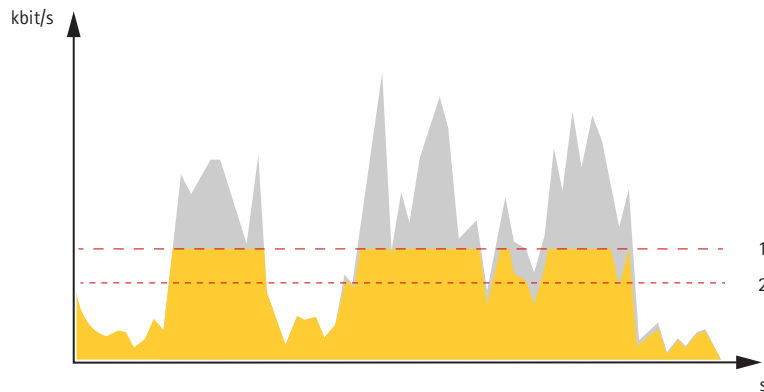

- 1 Target bitrate
- 2 Actual average bitrate

Applications

AXIS Camera Application Platform (ACAP) is an open platform that enables third parties to develop analytics and other applications for Axis products. To find out more about available applications, downloads, trials and licenses, go to axis.com/applications.

To find the user manuals for Axis applications, go to axis.com.

Note

- Several applications can run at the same time but some applications might not be compatible with each other. Certain combinations of applications might require too much processing power or memory resources when run in parallel. Verify that the applications work together before deployment.



To watch this video, go to the web version of this document.

www.axis.com/products/online-manual/49037#t10001688

How to download and install an application

AXIS M30 Net

Learn more



To watch this video, go to the web version of this document.

www.axis.com/products/online-manual/49037#t10001688

How to activate an application licence code on a device

AXIS M30 Network Camera Series

Troubleshooting

Troubleshooting

Reset to factory default settings

Important

Reset to factory default should be used with caution. A reset to factory default resets all settings, including the IP address, to the factory default values.

To reset the product to the factory default settings:

1. Disconnect power from the product.
2. Press and hold the control button while reconnecting power. See *Product overview on page 26*.
3. Keep the control button pressed for 15–30 seconds until the status LED indicator flashes amber.
4. Release the control button. The process is complete when the status LED indicator turns green. The product has been reset to the factory default settings. If no DHCP server is available on the network, the default IP address is 192.168.0.90.
5. Use the installation and management software tools to assign an IP address, set the password, and access the video stream.

The installation and management software tools are available from the support pages on axis.com/support.

It is also possible to reset parameters to factory default through the web interface. Go to **Settings > System > Maintenance** and click **Default**.

Firmware options

Axis offers product firmware management according to either the active track or the long-term support (LTS) tracks. Being on the active track means continuously getting access to all the latest product features, while the LTS tracks provide a fixed platform with periodic releases focused mainly on bug fixes and security updates.

Using firmware from the active track is recommended if you want to access the newest features, or if you use Axis end-to-end system offerings. The LTS tracks are recommended if you use third-party integrations, which are not continuously validated against the latest active track. With LTS, the products can maintain cybersecurity without introducing any significant functional changes or affecting any existing integrations. For more detailed information about Axis product firmware strategy, go to axis.com/support/firmware.

Check the current firmware

Firmware is the software that determines the functionality of network devices. One of your first actions when troubleshooting a problem should be to check the current firmware version. The latest version may contain a correction that fixes your particular problem.

To check the current firmware:

1. Go to the product's webpage.
2. Click the help menu .
3. Click **About**.

Upgrade the firmware

Important

Preconfigured and customized settings are saved when the firmware is upgraded (provided that the features are available in the new firmware) although this is not guaranteed by Axis Communications AB.

AXIS M30 Network Camera Series

Troubleshooting

Important

Make sure the product remains connected to the power source throughout the upgrade process.

Note

When you upgrade the product with the latest firmware in the active track, the product receives the latest functionality available. Always read the upgrade instructions and release notes available with each new release before upgrading the firmware. To find the latest firmware and the release notes, go to axis.com/support/firmware.

AXIS Device Manager can be used for multiple upgrades. Find out more at axis.com/products/axis-device-manager.



To watch this video, go to the web version of this document.

www.axis.com/products/online-manual/49037#t10095327

How to upgrade the firmware

1. Download the firmware file to your computer, available free of charge at axis.com/support/firmware.
2. Log in to the product as an administrator.
3. Go to **Settings > System > Maintenance**. Follow the instructions on the page. When the upgrade has finished, the product restarts automatically.

Technical issues, clues and solutions

If you can't find what you're looking for here, try the troubleshooting section at axis.com/support.

Problems upgrading the firmware

Firmware upgrade failure	If the firmware upgrade fails, the device reloads the previous firmware. The most common reason is that the wrong firmware file has been uploaded. Check that the name of the firmware file corresponds to your device and try again.
--------------------------	---

Problems setting the IP address

The device is located on a different subnet	If the IP address intended for the device and the IP address of the computer used to access the device are located on different subnets, you cannot set the IP address. Contact your network administrator to obtain an IP address.
---	---

AXIS M30 Network Camera Series

Troubleshooting

The IP address is being used by another device	Disconnect the Axis device from the network. Run the ping command (in a Command/DOS window, type <code>ping</code> and the IP address of the device): <ul style="list-style-type: none">If you receive: <code>Reply from <IP address>: bytes=32; time=10...</code> this means that the IP address may already be in use by another device on the network. Obtain a new IP address from the network administrator and reinstall the device.If you receive: <code>Request timed out</code>, this means that the IP address is available for use with the Axis device. Check all cabling and reinstall the device.
Possible IP address conflict with another device on the same subnet	The static IP address in the Axis device is used before the DHCP server sets a dynamic address. This means that if the same default static IP address is also used by another device, there may be problems accessing the device.

The device cannot be accessed from a browser

Cannot log in	When HTTPS is enabled, ensure that the correct protocol (HTTP or HTTPS) is used when attempting to log in. You may need to manually type <code>http</code> or <code>https</code> in the browser's address field. If the password for the user <code>root</code> is lost, the device must be reset to the factory default settings. See <i>Reset to factory default settings on page 22</i> .
The IP address has been changed by DHCP	IP addresses obtained from a DHCP server are dynamic and may change. If the IP address has been changed, use AXIS IP Utility or AXIS Device Manager to locate the device on the network. Identify the device using its model or serial number, or by the DNS name (if the name has been configured). If required, a static IP address can be assigned manually. For instructions, go to axis.com/support .
Certificate error when using IEEE 802.1X	For authentication to work properly, the date and time settings in the Axis device must be synchronized with an NTP server. Go to Settings > System > Date and time .

The device is accessible locally but not externally

To access the device externally, we recommend using one of the following applications for Windows®:

- AXIS Companion: free of charge, ideal for small systems with basic surveillance needs.
- AXIS Camera Station: 30-day trial version free of charge, ideal for small to mid-size systems.

For instructions and download, go to axis.com/vms.

Problems with streaming

Multicast H.264 only accessible by local clients	Check if your router supports multicasting, or if the router settings between the client and the device need to be configured. The TTL (Time To Live) value may need to be increased.
No multicast H.264 displayed in the client	Check with your network administrator that the multicast addresses used by the Axis device are valid for your network. Check with your network administrator to see if there is a firewall preventing viewing.
Poor rendering of H.264 images	Ensure that your graphics card is using the latest driver. The latest drivers can usually be downloaded from the manufacturer's website.
Color saturation is different in H.264 and Motion JPEG	Modify the settings for your graphics adapter. Go to the adapter's documentation for more information.
Lower frame rate than expected	<ul style="list-style-type: none">See <i>Performance considerations on page 25</i>.Reduce the number of applications running on the client computer.Limit the number of simultaneous viewers.Check with the network administrator that there is enough bandwidth available.Lower the image resolution.The maximum frames per second is dependent on the utility frequency (60/50 Hz) of the Axis device.
Can't select H.265 encoding in live view	Web browsers do not support H.265 decoding. Use a video management system or application supporting H.265 decoding.

AXIS M30 Network Camera Series

Troubleshooting

Performance considerations

When setting up your system, it is important to consider how various settings and situations affect the performance. Some factors affect the amount of bandwidth (the bitrate) required, others can affect the frame rate, and some affect both. If the load on the CPU reaches its maximum, this also affects the frame rate.

The following factors are the most important to consider:

- High image resolution or lower compression levels result in images containing more data which in turn affects the bandwidth.
- Rotating the image in the GUI will increase the product's CPU load.
- Access by large numbers of Motion JPEG or unicast H.264 clients affects the bandwidth.
- Simultaneous viewing of different streams (resolution, compression) by different clients affects both frame rate and bandwidth.

Use identical streams wherever possible to maintain a high frame rate. Stream profiles can be used to ensure that streams are identical.

- Accessing Motion JPEG and H.264 video streams simultaneously affects both frame rate and bandwidth.
- Heavy usage of event settings affects the product's CPU load which in turn affects the frame rate.
- Using HTTPS may reduce frame rate, in particular if streaming Motion JPEG.
- Heavy network utilization due to poor infrastructure affects the bandwidth.
- Viewing on poorly performing client computers lowers perceived performance and affects frame rate.
- Running multiple AXIS Camera Application Platform (ACAP) applications simultaneously may affect the frame rate and the general performance.

Contact support

Contact support at axis.com/support.

AXIS M30 Network Camera Series

Specifications

Specifications

Product overview

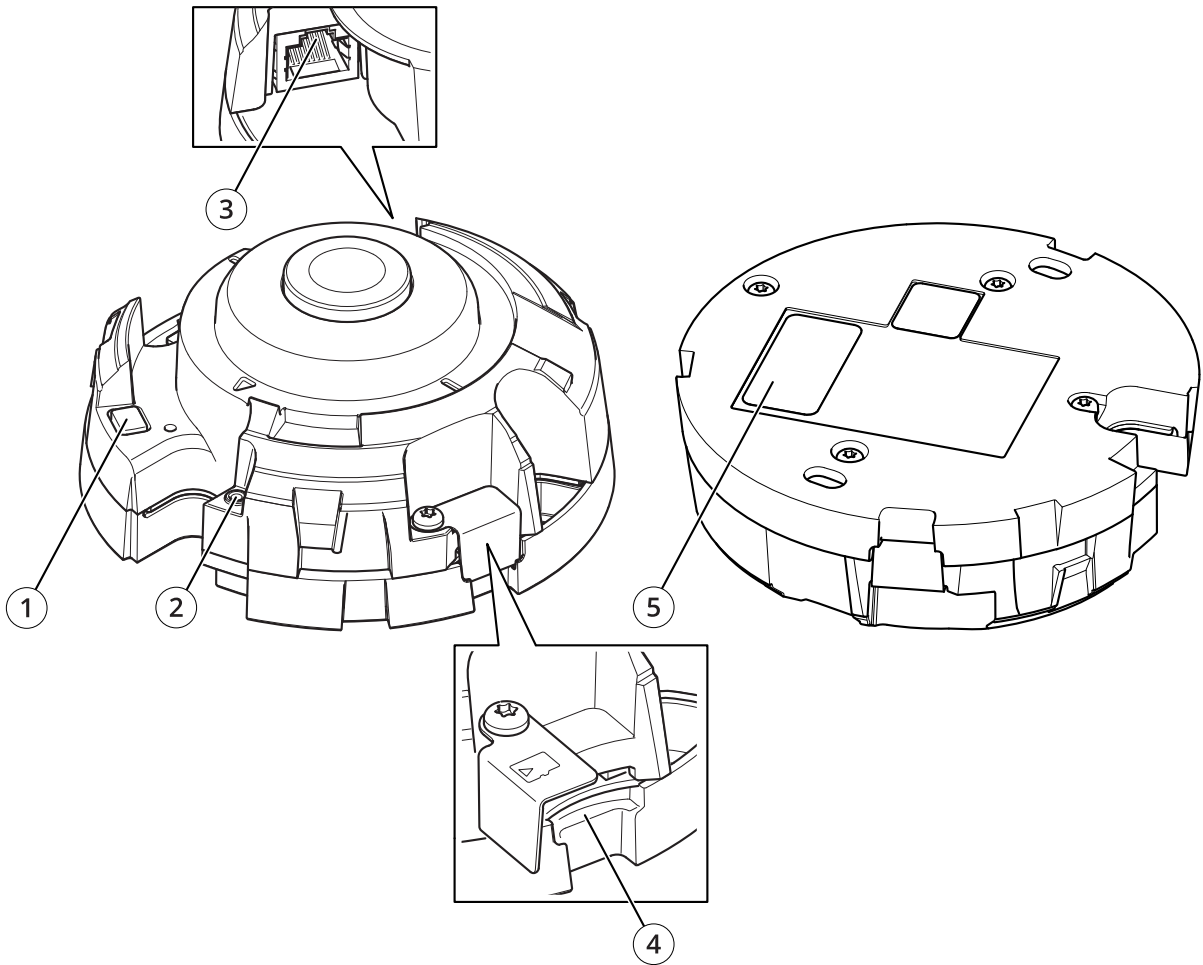

- 1 Control button
- 2 Status LED indicator
- 3 Network connector (PoE)
- 4 SD card slot
- 5 Part number (P/N) & Serial number (S/N)

LED indicators

Note

The Status LED can be configured to flash while an event is active.

Status LED	Indication
Unlit	Connection and normal operation.
Green	Shows steady green for 10 seconds for normal operation after startup completed.

AXIS M30 Network Camera Series

Specifications

Amber	Steady during startup. Flashes during firmware upgrade or reset to factory default.
Amber/Red	Flashes amber/red if network connection is unavailable or lost.
Red	Firmware upgrade failure.

SD card slot

NOTICE

- Risk of damage to SD card. Do not use sharp tools, metal objects, or excessive force when inserting or removing the SD card. Use your fingers to insert and remove the card.
- Risk of data loss and corrupted recordings. Do not remove the SD card while the product is running. Unmount the SD card from the product's webpage before removal.

This product supports microSD/microSDHC/microSDXC cards.

For SD card recommendations, see axis.com.



microSD, microSDHC, and microSDXC Logos are trademarks of SD-3C LLC. microSD, microSDHC, microSDXC are trademarks or registered trademarks of SD-3C, LLC in the United States, other countries or both.

Buttons

Control button

The control button is used for:

- Resetting the product to factory default settings. See *Reset to factory default settings on page 22*.

Connectors

Network connector

RJ45 Ethernet connector with Power over Ethernet (PoE).

