

## **AXIS Q6135-LE Network Camera**

## **User Manual**

# AXIS Q6135-LE Network Camera

## Table of Contents

---

<b>Product overview</b> .....	3
<b>Find the device on the network</b> .....	4
Access the device .....	4
Secure passwords .....	4
<b>Additional settings</b> .....	6
Webpage overview .....	6
Image quality .....	7
Privacy masks .....	9
Overlays .....	10
Pan, tilt, and zoom (PTZ) .....	11
Streaming and storage .....	13
Events .....	14
Applications .....	16
<b>Troubleshooting</b> .....	19
Reset to factory default settings .....	19
Check the current firmware .....	19
Upgrade the firmware .....	19
Technical issues, clues and solutions .....	20
Performance considerations .....	21
<b>Specifications</b> .....	23
LED indicators .....	23
SD card slot .....	23
Buttons .....	23
Connectors .....	23

# AXIS Q6135-LE Network Camera

## Product overview

---

### Product overview

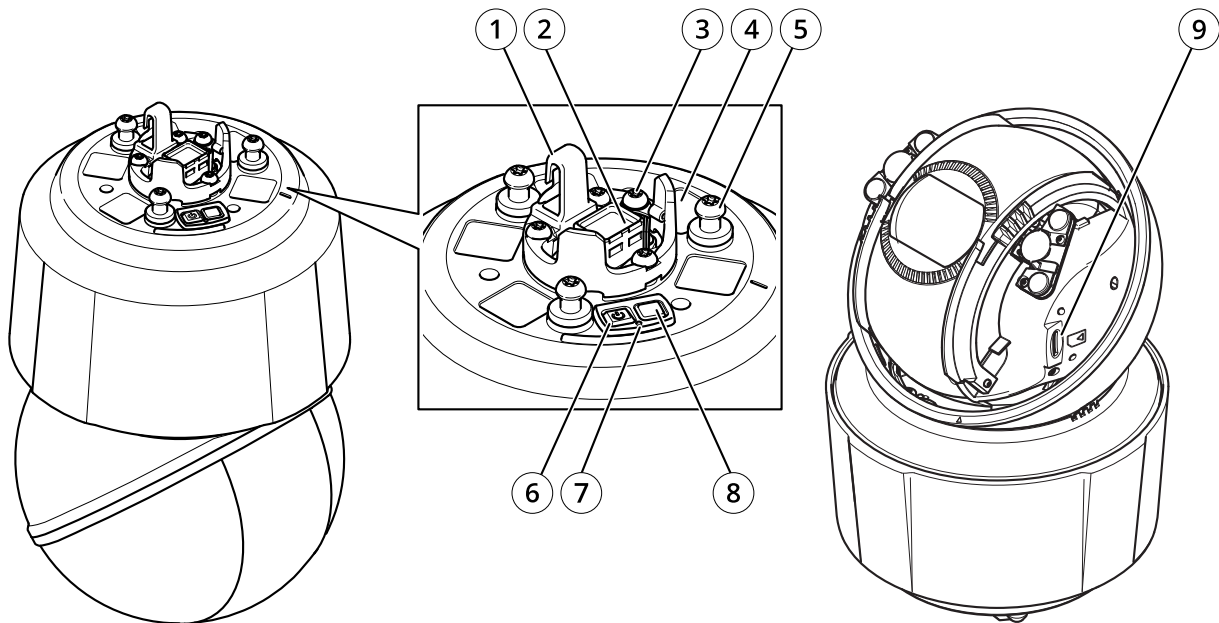

- 1 Hook for safety wire
- 2 Network connector
- 3 Ground screw
- 4 Part number (P/N) & Serial number (S/N)
- 5 Unit holder (3x)
- 6 Power button
- 7 Status LED indicator
- 8 Control button
- 9 microSD/microSDHC/microSDXC

# AXIS Q6135-LE Network Camera

## Find the device on the network

---

### Find the device on the network

To find Axis devices on the network and assign them IP addresses in Windows®, use AXIS IP Utility or AXIS Device Manager. Both applications are free and can be downloaded from [axis.com/support](http://axis.com/support).

For more information about how to find and assign IP addresses, go to *How to assign an IP address and access your device*.

### Access the device

1. Open a browser and enter the IP address or host name of the Axis device.  
If you do not know the IP address, use AXIS IP Utility or AXIS Device Manager to find the device on the network.
2. Enter the username and password. If you access the device for the first time, you must set the root password. See *Set a new password for the root account on page 4*.
3. The live view page opens in your browser.

### Secure passwords

#### Important

Axis devices send the initially set password in clear text over the network. To protect your device after the first login, set up a secure and encrypted HTTPS connection and then change the password.

The device password is the primary protection for your data and services. Axis devices do not impose a password policy as they may be used in various types of installations.

To protect your data we strongly recommend that you:

- Use a password with at least 8 characters, preferably created by a password generator.
- Don't expose the password.
- Change the password at a recurring interval, at least once a year.

### Set a new password for the root account

#### Important

The default administrator username is **root**. If the password for root is lost, reset the device to factory default settings. See *Reset to factory default settings on page 19*



To watch this video, go to the web version of this document.

[www.axis.com/products/online-manual/58443#t10098905](http://www.axis.com/products/online-manual/58443#t10098905)

*Support tip: Password security confirmation check*

1. Type a password. Follow the instructions about secure passwords. See *Secure passwords on page 4*.

# AXIS Q6135-LE Network Camera

## Find the device on the network

---

2. Retype the password to confirm the spelling.
3. Click **Create login**. The password has now been configured.

# AXIS Q6135-LE Network Camera

## Additional settings

---

### Additional settings

### Webpage overview



- 1 *Live view control bar*
- 2 *Live view*
- 3 *Product name*
- 4 *User information, color themes, and help*
- 5 *Video control bar*
- 6 *Settings toggle*

# AXIS Q6135-LE Network Camera

## Additional settings

---

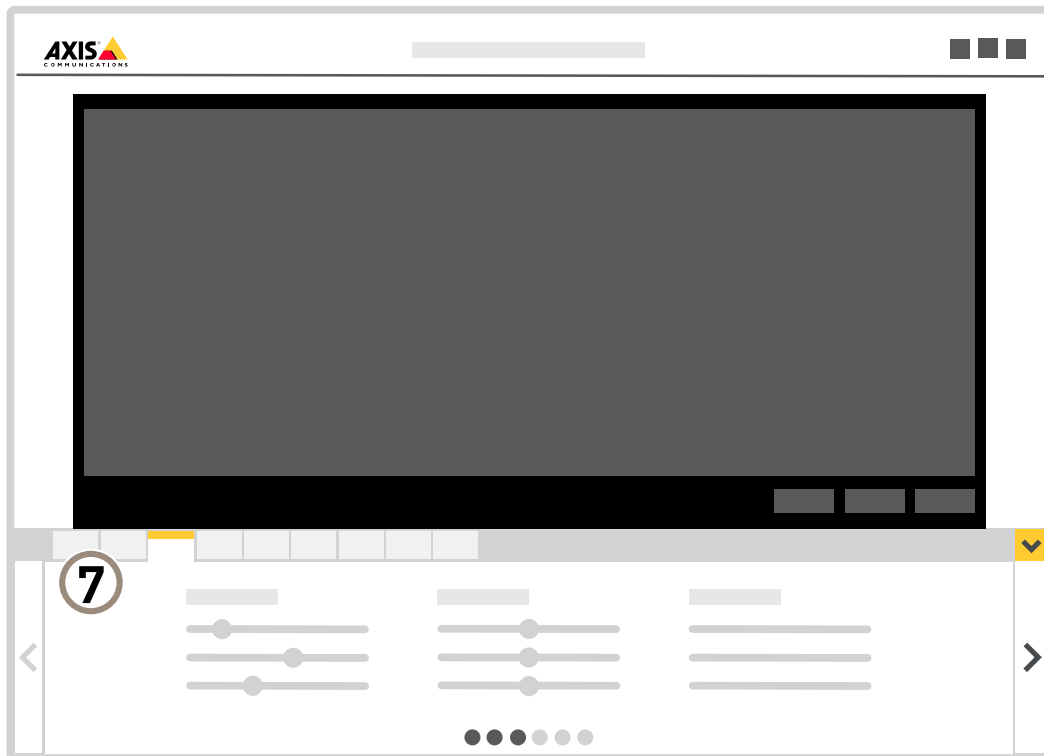

7 Settings tabs

### Need more help?

You can access the built-in help from the device's webpage. The help provides more detailed information on the device's features and their settings.

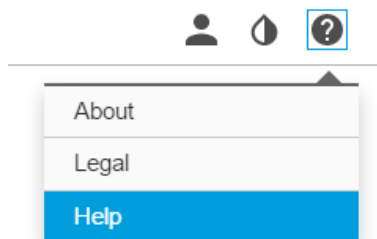

# AXIS Q6135-LE Network Camera

## Additional settings

---

### Image quality

#### Benefit from IR light in low-light conditions using night mode

Your camera uses visible light to deliver color images during the day. As the available light diminishes, you can set the camera to automatically shift to night mode, in which the camera uses both visible light and near-infrared light to deliver black-and-white images. Since the camera uses more of the available light it can deliver brighter, more detailed, images.

1. Go to **Settings > Image > Day and night**, and make sure that the **IR cut filter** is set to **Auto**.
2. To determine at what light level you want the camera to shift to night mode, move the **Threshold** slider toward **Bright** or **Dark**.
3. Enable **Allow IR illumination** and **Synchronize IR illumination** to use the camera's IR light when night mode is activated.

#### Note

If you set the shift to night mode to occur when it's brighter, the image remains sharper as there will be less low-light noise. If you set the shift to occur when it's darker, the image colors are maintained for longer, but there will be more image blur due to low-light noise.

#### Reduce motion blur in low-light conditions

To reduce motion blur in low-light conditions, adjust one or more of the following settings in **Settings > Image > Exposure**:

- Move the **Blur-noise trade-off** slider toward **Low motion blur**.

#### Note

When you increase the gain, image noise also increases.

- Set **Max shutter** to a shorter time, and **Max gain** to a higher value.

If you still have problems with motion blur:

- Increase the light level in the scene.
- Mount the camera so that objects move toward it or away from it rather than sideways.

#### Handle scenes with strong backlight

Dynamic range is the difference in light levels in an image. In some cases the difference between the darkest and the brightest areas can be significant. The result is often an image where either the dark or the bright areas are visible. Wide dynamic range (WDR) makes both dark and bright areas of the image visible.



*Image without WDR.*



# AXIS Q6135-LE Network Camera

## Additional settings

---



*Image with WDR.*

### Note

- WDR can cause artifacts in the image.
  - WDR may not be available for all capture modes.
1. Go to **Settings > Image > Wide dynamic range**.
  2. Turn on WDR.
  3. If you still have problems, go to **Exposure** and adjust the **Exposure zone** to cover the area of interest.

Find out more about WDR and how to use it at [axis.com/web-articles/wdr](https://axis.com/web-articles/wdr).

### Increase image quality in rainy weather with speed dry

The speed dry function helps to provide sharp images in rainy weather. It can also simplify dome cleaning, as it allows for more efficient methods such as high pressure cleaning. With the speed dry function activated, the dome vibrates at high speed. It breaks the surface tension of the water and removes the drops.



*Snapshot from a camera's live view before and after speed dry has been activated.*

1. Click the **Speed dry** button in the live view control bar.

### Privacy masks

A privacy mask is a user-defined area that covers a part of the monitored area. In the video stream, privacy masks appear either as blocks of solid color or with a mosaic pattern.

The privacy mask is relative to the pan, tilt, and zoom coordinates, so regardless of where you point the camera, the privacy mask covers the same place or object.

You'll see the privacy mask on all snapshots, recorded video, and live streams.

# AXIS Q6135-LE Network Camera

## Additional settings

---

You can use the VAPIX® application programming interface (API) to turn off the privacy masks.

### Important

If you use multiple privacy masks it may affect the product's performance.

### Hide parts of the image with privacy masks

You can create one or several privacy masks to hide parts of the image.



*How to create a privacy mask*

1. Go to **Settings > Privacy mask**.
2. Click **New**.
3. Adjust the size, color, and name of the privacy mask according to your needs.



*How to change the appearance of the mask*

## Overlays

Overlays are superimposed over the video stream. They are used to provide extra information during recordings, such as a timestamp, or during product installation and configuration. You can add either text or an image.

### How to display the pan or tilt position as a text overlay

You can show the pan or tilt position as an overlay in the image.

1. Go to **Settings > Overlay** and click **Create overlay**.
2. Select **Text** and click **Create**.
3. In the text field, type #x to show the pan position.

# AXIS Q6135-LE Network Camera

## Additional settings

---

Type #y to show the tilt position.

4. Choose text size and appearance.
5. To position the text overlay, choose **Custom** or one of the presets
6. The current pan and tilt positions show up in the live view image and in the recording.

### Add street names and compass direction to the image

#### Note

The street name and compass direction will be visible on all video streams and recordings.

Activate the compass ring

1. Go to **Settings > Apps**.
2. Select **Orientation Aid PTZ**.
3. Start the application and click **Open**.
4. Position the camera view at north with the crosshair. Click **Set north**.

Add a preset position

1. Go to **Settings > PTZ**.
2. Use the crosshair to position the view where you want to add a preset position.
3. Click the **+** to create a new preset position.

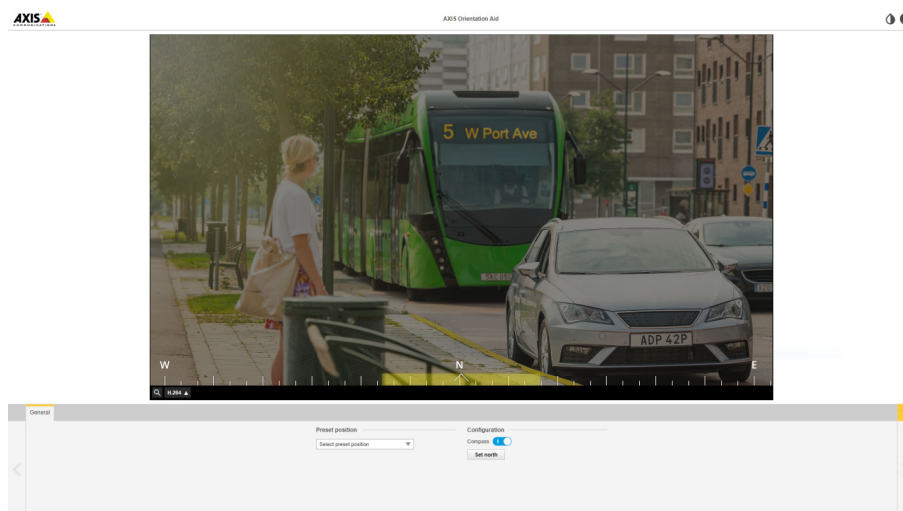

## Pan, tilt, and zoom (PTZ)

### Guard tours

A guard tour displays the video stream from different preset positions either in a predetermined or random order, and for configurable periods of time. Once started, a guard tour continues to run until stopped, even when there are no clients (web browsers) viewing the images.

# AXIS Q6135-LE Network Camera

## Additional settings

---

The guard tour function includes tour recording. This allows recording a custom tour using an input device, such as a joystick, a mouse, or a keyboard, or through using the VAPIX® Application Programming Interface (API). A recorded tour is a replay of a recorded sequence of pan/tilt/zoom movements, including their variable speeds and lengths.

### Create a guard tour with preset positions

A guard tour displays the video stream from different preset positions either in a predetermined or random order, and for configurable periods of time.



1. Go to **Settings > PTZ > Guard tours**.
2. Click **+**.
3. To edit the guard tour's properties, click  .
4. Type a name for the guard tour and specify the pause length in minutes between each tour.
5. If you want the guard tour to go to the preset positions in a random order, turn on **Shuffle**.
6. Click **Done**.
7. Click **Add** to add the preset positions that you want in your guard tour.
8. Click **Done** to exit the guard tour settings.
9. To schedule the guard tour, go to **System > Events**.



To watch this video, go to the web version of this document.

[www.axis.com/products/online-manual/58443#t10111157](http://www.axis.com/products/online-manual/58443#t10111157)

### Create a recorded guard tour

1. Go to **Settings > PTZ > Guard tours**.
2. Click **+**
3. Select **Recorded**.
4. To start recording the pan/tilt/zoom movements, click  .
5. When you're satisfied, click  .
6. If you re-record the guard tour you will overwrite the existing recorded guard tour.
7. To edit the guard tour's properties, click  .
8. Type a name for the guard tour and specify the pause length in minutes between each tour.
9. Click **Done** twice to exit the guard tour settings.

# AXIS Q6135-LE Network Camera

## Additional settings

---

10. To schedule the guard tour, go to **System > Events**.

### Streaming and storage

#### Video compression formats

Decide which compression method to use based on your viewing requirements, and on the properties of your network. The available options are:

##### H.264 or MPEG-4 Part 10/AVC

###### Note

H.264 is a licensed technology. The Axis product includes one H.264 viewing client license. To install additional unlicensed copies of the client is prohibited. To purchase additional licenses, contact your Axis reseller.

H.264 can, without compromising image quality, reduce the size of a digital video file by more than 80% compared to the Motion JPEG format and by as much as 50% compared to older MPEG formats. This means that less network bandwidth and storage space are required for a video file. Or seen another way, higher video quality can be achieved for a given bitrate.

##### H.265 or MPEG-H Part 2/HEVC

H.265 can, without compromising image quality, reduce the size of a digital video file by more than 25% compared to H.264.

###### Note

- H.265 is licensed technology. The Axis product includes one H.265 viewing client license. Installing additional unlicensed copies of the client is prohibited. To purchase additional licenses, contact your Axis reseller.
- Most web browsers don't support H.265 decoding and because of this the camera doesn't support it in its web interface. Instead you can use a video management system or application supporting H.265 decoding.

### Reduce bandwidth and storage

#### Important

If you reduce the bandwidth it can result in loss of details in the picture.

1. Go to live view and select **H.264**.
2. Go to **Settings > Stream**.
3. Do one or more of the following:

###### Note

The zipstream settings are used for both H.264 and H.265.

- Turn on dynamic GOP and set a high GOP length value.
- Increase the compression.
- Turn on dynamic FPS.

###### Note

Web browsers do not support H.265 decoding. Use a video management system or application supporting H.265 decoding.

### Set up network storage

To store recordings on the network, you need to set up your network storage.

1. Go to **Settings > System > Storage**.

# AXIS Q6135-LE Network Camera

## Additional settings

---

2. Click **Setup** under **Network storage**.
3. Enter the IP address of the host server.
4. Enter the name of the shared location on the host server.
5. Move the switch if the share requires a login, and enter username and password.
6. Click **Connect**.

## Events

### Set up rules for events

You can create rules to make your device perform an action when certain events occur. A rule consists of conditions and actions. The conditions can be used to trigger the actions. For example, the device can start a recording or send an email when it detects motion, or show an overlay text while the device is recording.

To learn more, check out our guide *Get started with rules for events*.

### Record video when the camera detects motion

This example explains how to set up the camera to start recording to the SD card five seconds before it detects motion and to stop one minute after.



To watch this video, go to the web version of this document.

[www.axis.com/products/online-manual/58443#t10106619](http://www.axis.com/products/online-manual/58443#t10106619)

*How to record a video stream when the camera detects motion*

Make sure that AXIS Video Motion Detection is running:

1. Go to **Settings > Apps > AXIS Video Motion Detection**.
2. Start the application if it is not already running.
3. Make sure you have set up the application according to your needs. If you need help, see the *user manual for AXIS Video Motion Detection 4*.

Create a rule:

1. Go to **Settings > System > Events** and add a rule.
2. Type a name for the rule.
3. In the list of conditions, under **Application**, select **AXIS Video Motion Detection (VMD)**.
4. In the list of actions, under **Recordings**, select **Record video while the rule is active**.
5. Select an existing stream profile or create a new one.

# AXIS Q6135-LE Network Camera

## Additional settings

---

6. Set the prebuffer time to 5 seconds.
7. Set the postbuffer time to 60 seconds.
8. In the list of storage options, select **SD card**.
9. Click **Save**.

### Direct the camera to a preset position when the camera detects motion

This example explains how to set up the camera to go to a preset position when it detects motion in the image.



To watch this video, go to the web version of this document.

[www.axis.com/products/online-manual/58443#t10101129](http://www.axis.com/products/online-manual/58443#t10101129)

Make sure that AXIS Video Motion Detection is running:

1. Go to **Settings > Apps > AXIS Video Motion Detection**.
2. Start the application if it is not already running.
3. Make sure you have set up the application according to your needs. If you need help, see the *user manual for AXIS Video Motion Detection 4*.

Add a preset position:

Go to **Settings > PTZ** and set where you want the camera to be directed by creating a preset position.

Create a rule:

1. Go to **Settings > System > Events > Rules** and add a rule.
2. Type a name for the rule.
3. In the list of conditions, select a video motion detection condition under **Application**.
4. From the list of actions, select **Go to preset position**.
5. Select the preset position you want the camera to go to.
6. Click **Save**.

### Zoom in on a specific area automatically with gatekeeper

This example explains how to use the gatekeeper functionality to make the camera zoom in automatically on the license plate of a car that passes through a gate. When the car has passed, the camera zooms out to the home position.

Create the preset positions:

1. Go to **Settings > PTZ > Preset positions**.
2. Create the home position that includes the entrance of the gate.

# AXIS Q6135-LE Network Camera

## Additional settings

---

3. Create the zoomed-in preset position so that it covers the area in the image where you assume that the license plate will appear.

Create a motion detection profile:

1. Go to **Settings > Apps** and open **AXIS Video Motion Detection**.
2. Create a profile that covers the entrance of the gate and then save the profile.

Create a rule:

1. Go to **Settings > System > Events** and add a rule.
2. Name the rule "Gatekeeper".
3. In the list of conditions, under **Application**, select the motion detection profile.
4. In the list of actions, under **Preset positions**, select **Go to preset position**.
5. Select a **Video channel**.
6. Select the **Preset position**.
7. To make the camera wait a while before it returns to the home position, select **Home timeout**, and set a time.
8. Click **Save**.

### Record video when the camera detects impact

Shock detection allows the camera to detect tampering caused by vibrations or shock. Vibrations due to the environment or to an object can trigger an action depending on the shock sensitivity range, which can be set from 0 to 100. In this scenario, someone is throwing rocks at the camera after hours and you would like to get a video clip of the event.

Turn on shock detection:

1. Go to **Settings > System > Detectors**.
2. Turn on shock detection, and set a value for the shock sensitivity.

Create a rule:

1. Go to **Settings > System > Events** and add a rule.
2. Type a name for the rule.
3. In the list of conditions, under **Device status**, select **Shock detected**.
4. Click **+** to add a second condition.
5. In the list of conditions, under **Scheduled and recurring**, select **Scheduled event**.
6. In the list of schedules, select **After hours**.
7. In the list of actions, under **Recordings**, select **Record video while the rule is active**.
8. Select a **Camera**.
9. Set the prebuffer time to 5 seconds.
10. Set the postbuffer time to 60 seconds.
11. Select where to save the recordings.
12. Click **Save**.



# AXIS Q6135-LE Network Camera

## Additional settings

---

### Applications

#### Applications

AXIS Camera Application Platform (ACAP) is an open platform that enables third parties to develop analytics and other applications for Axis products. To find out more about available applications, downloads, trials and licenses, go to [axis.com/applications](http://axis.com/applications).

To find the user manuals for Axis applications, go to [axis.com](http://axis.com).

#### Note

- Several applications can run at the same time but some applications might not be compatible with each other. Certain combinations of applications might require too much processing power or memory resources when run in parallel. Verify that the applications work together before deployment.



To watch this video, go to the web version of this document.

[www.axis.com/products/online-manual/58443#t10001688](http://www.axis.com/products/online-manual/58443#t10001688)

*How to download and install an application*



To watch this video, go to the web version of this document.

[www.axis.com/products/online-manual/58443#t10001688](http://www.axis.com/products/online-manual/58443#t10001688)

*How to activate an application licence code on a device*

### Autotracking

With autotracking, the camera automatically zooms in on and tracks moving objects, for example a vehicle or a person. You can manually select an object to track, or set up trigger areas and let the camera detect moving objects. The application is best suited for open areas with no obscuring objects and where movement is unusual. When the camera doesn't track an object, it returns to its connected preset position.

#### Important

- Autotracking is designed for areas with a limited amount of movement.
- Autotracking does not track objects behind privacy masks.
- If both autotracking and guard tour are enabled, guard tour takes priority over autotracking. This means autotracking stops if a guard tour starts.

# AXIS Q6135-LE Network Camera

## Additional settings

---

### Set up Autotracking 2

This example explains how to set up the camera to track moving objects in an area of interest.

In the device's webpage:

1. Go to **Settings > PTZ**.
2. Direct the camera view to the area you want to track.
3. Click **+** and create a **preset position**.
4. Go to **Apps > AXIS PTZ Autotracking**.
5. Start and open the application.

In the application:

1. Go to **Settings > Profiles**.
2. Click **+** and create a **profile**.
3. Select the preset position you created in the device's webpage.
4. Click **Done**.
5. Select a **Trigger area**.
6. Go to **Settings > Filters**:
  - To exclude small objects, set width and height.
  - To exclude short-lived objects, set a time between 1 and 5 seconds.
7. Click **Autotracking** to start tracking.

# AXIS Q6135-LE Network Camera

## Troubleshooting

---

### Troubleshooting

#### Reset to factory default settings

##### Important

Reset to factory default should be used with caution. A reset to factory default resets all settings, including the IP address, to the factory default values.

- Press and hold the control button and the power button. See *Product overview on page 3*.
- Release the power button but continue to hold down the control button for 15–30 seconds.
- Release the control button.
- The process is now complete. The product has been reset to the factory default settings. If no DHCP server is available on the network, the default IP address is 192.168.0.90.
- Using the installation and management software tools, assign an IP address, set the password and access the video stream.

It is also possible to reset parameters to factory default through the web interface. Go to **Settings > System > Maintenance** and click **Default**.

#### Check the current firmware

Firmware is the software that determines the functionality of network devices. One of your first actions when troubleshooting a problem should be to check the current firmware version. The latest version may contain a correction that fixes your particular problem.

To check the current firmware:

1. Go to the product's webpage.
2. Click the help menu .
3. Click **About**.

#### Upgrade the firmware

##### Important

Preconfigured and customized settings are saved when the firmware is upgraded (provided that the features are available in the new firmware) although this is not guaranteed by Axis Communications AB.

##### Important

Make sure the product remains connected to the power source throughout the upgrade process.

##### Note

When you upgrade the product with the latest firmware in the active track, the product receives the latest functionality available. Always read the upgrade instructions and release notes available with each new release before upgrading the firmware. To find the latest firmware and the release notes, go to [axis.com/support/firmware](https://axis.com/support/firmware).

AXIS Device Manager can be used for multiple upgrades. Find out more at [axis.com/products/axis-device-manager](https://axis.com/products/axis-device-manager).

# AXIS Q6135-LE Network Camera

## Troubleshooting

---



To watch this video, go to the web version of this document.

[www.axis.com/products/online-manual/58443#t10095327](http://www.axis.com/products/online-manual/58443#t10095327)

*How to upgrade the firmware*

1. Download the firmware file to your computer, available free of charge at [axis.com/support/firmware](http://axis.com/support/firmware).
2. Log in to the product as an administrator.
3. Go to **Settings > System > Maintenance**. Follow the instructions on the page. When the upgrade has finished, the product restarts automatically.

## Technical issues, clues and solutions

If you can't find what you're looking for here, try the troubleshooting section at [axis.com/support](http://axis.com/support).

### Problems upgrading the firmware

---

**Firmware upgrade failure** If the firmware upgrade fails, the device reloads the previous firmware. The most common reason is that the wrong firmware file has been uploaded. Check that the name of the firmware file corresponds to your device and try again.

### Problems setting the IP address

---

**The device is located on a different subnet** If the IP address intended for the device and the IP address of the computer used to access the device are located on different subnets, you cannot set the IP address. Contact your network administrator to obtain an IP address.

**The IP address is being used by another device** Disconnect the Axis device from the network. Run the ping command (in a Command/DOS window, type `ping` and the IP address of the device):

- If you receive: `Reply from <IP address>: bytes=32; time=10...` this means that the IP address may already be in use by another device on the network. Obtain a new IP address from the network administrator and reinstall the device.
- If you receive: `Request timed out`, this means that the IP address is available for use with the Axis device. Check all cabling and reinstall the device.

**Possible IP address conflict with another device on the same subnet** The static IP address in the Axis device is used before the DHCP server sets a dynamic address. This means that if the same default static IP address is also used by another device, there may be problems accessing the device.

### The device cannot be accessed from a browser

---

**Cannot log in** When HTTPS is enabled, ensure that the correct protocol (HTTP or HTTPS) is used when attempting to log in. You may need to manually type `http` or `https` in the browser's address field.

If the password for the user `root` is lost, the device must be reset to the factory default settings. See *Reset to factory default settings on page 19*.

**The IP address has been changed by DHCP** IP addresses obtained from a DHCP server are dynamic and may change. If the IP address has been changed, use AXIS IP Utility or AXIS Device Manager to locate the device on the network. Identify the device using its model or serial number, or by the DNS name (if the name has been configured).

If required, a static IP address can be assigned manually. For instructions, go to [axis.com/support](http://axis.com/support).

# AXIS Q6135-LE Network Camera

## Troubleshooting

---

### The device is accessible locally but not externally

---

To access the device externally, we recommend using one of the following applications for Windows®:

- AXIS Companion: free of charge, ideal for small systems with basic surveillance needs.
- AXIS Camera Station: 30-day trial version free of charge, ideal for small to mid-size systems.

For instructions and download, go to [axis.com/vms](http://axis.com/vms).

### Problems with streaming

---

Multicast H.264 only accessible by local clients	Check if your router supports multicasting, or if the router settings between the client and the device need to be configured. The TTL (Time To Live) value may need to be increased.
No multicast H.264 displayed in the client	Check with your network administrator that the multicast addresses used by the Axis device are valid for your network.  Check with your network administrator to see if there is a firewall preventing viewing.
Poor rendering of H.264 images	Ensure that your graphics card is using the latest driver. The latest drivers can usually be downloaded from the manufacturer's website.
Color saturation is different in H.264 and Motion JPEG	Modify the settings for your graphics adapter. Go to the adapter's documentation for more information.
Lower frame rate than expected	<ul style="list-style-type: none"><li>• See <i>Performance considerations on page 21</i>.</li><li>• Reduce the number of applications running on the client computer.</li><li>• Limit the number of simultaneous viewers.</li><li>• Check with the network administrator that there is enough bandwidth available.</li><li>• Lower the image resolution.</li><li>• Log in to the device's webpage and set a capture mode that prioritizes frame rate. Changing the capture mode to prioritize frame rate might lower the maximum resolution depending on the device used and capture modes available.</li><li>• The maximum frames per second is dependent on the utility frequency (60/50 Hz) of the Axis device.</li></ul>
Can't select H.265 encoding in live view	Web browsers do not support H.265 decoding. Use a video management system or application supporting H.265 decoding.

## Performance considerations

When setting up your system, it is important to consider how various settings and situations affect the performance. Some factors affect the amount of bandwidth (the bitrate) required, others can affect the frame rate, and some affect both. If the load on the CPU reaches its maximum, this also affects the frame rate.

The following factors are the most important to consider:

- High image resolution or lower compression levels result in images containing more data which in turn affects the bandwidth.
- Rotating the image in the GUI will increase the product's CPU load.
- Access by large numbers of Motion JPEG or unicast H.264 clients affects the bandwidth.
- Access by large numbers of Motion JPEG or unicast H.265 clients affects the bandwidth.
- Simultaneous viewing of different streams (resolution, compression) by different clients affects both frame rate and bandwidth.

Use identical streams wherever possible to maintain a high frame rate. Stream profiles can be used to ensure that streams are identical.

- Accessing Motion JPEG and H.264 video streams simultaneously affects both frame rate and bandwidth.
- Accessing Motion JPEG and H.265 video streams simultaneously affects both frame rate and bandwidth.

# AXIS Q6135-LE Network Camera

## Troubleshooting

---

- Heavy usage of event settings affects the product's CPU load which in turn affects the frame rate.
- Using HTTPS may reduce frame rate, in particular if streaming Motion JPEG.
- Heavy network utilization due to poor infrastructure affects the bandwidth.
- Viewing on poorly performing client computers lowers perceived performance and affects frame rate.
- Running multiple AXIS Camera Application Platform (ACAP) applications simultaneously may affect the frame rate and the general performance.

# AXIS Q6135-LE Network Camera

## Specifications

---

### Specifications

#### LED indicators

Status LED	Indication
Unlit	Connection and normal operation.
Green	Shows steady green for 10 seconds for normal operation after startup completed.
Amber	Steady during startup. Flashes during firmware upgrade or reset to factory default.
Amber/Red	Flashes amber/red if network connection is unavailable or lost.

#### SD card slot

##### **NOTICE**

- Risk of damage to SD card. Do not use sharp tools, metal objects, or excessive force when inserting or removing the SD card. Use your fingers to insert and remove the card.
- Risk of data loss and corrupted recordings. Do not remove the SD card while the product is running. Unmount the SD card from the product's webpage before removal.

This product supports microSD/microSDHC/microSDXC cards.

For SD card recommendations, see [axis.com](http://axis.com).

 microSD, microSDHC, and microSDXC Logos are trademarks of SD-3C LLC. microSD, microSDHC, microSDXC are trademarks or registered trademarks of SD-3C, LLC in the United States, other countries or both.

#### Buttons

##### Control button

The control button is used for:

- Resetting the product to factory default settings. See *Reset to factory default settings on page 19*.

##### Power button

The power button is used with the control button to reset the camera to factory default settings. See *page 19*.

#### Connectors

##### Network connector

RJ45 Push-pull Connector (IP66) with High Power over Ethernet (High PoE).

##### **NOTICE**

To comply with the IP66-rated design of the camera and maintain the IP66 protection, the supplied RJ45 Push-pull Connector (IP66) shall be used. Alternatively, use the RJ45 IP66-rated cable with premounted connector which is available from your Axis reseller. Do not remove the plastic network connector shield from the camera.

