

AXIS C15 Series

AXIS C1510 Network Pendant Speaker

AXIS C1511 Network Pendant Speaker

AXIS C15 Series

Table of Contents

Solution overview	3
Installation	4
Get started	5
Find the device on the network	5
Access the device	5
Additional settings	7
Calibrate and run a remote speaker test	7
Set up direct SIP (P2P)	7
Set up SIP through a server (PBX)	8
Set up rules for events	8
Learn more	13
Session Initiation Protocol (SIP)	13
Peer-to-peer SIP (P2PSIP)	13
Private Branch Exchange (PBX)	13
NAT traversal	14
Applications	14
The web interface	15
Status	15
Audio	16
Recordings	17
Apps	18
System	18
Maintenance	36
Troubleshooting	37
Reset to factory default settings	37
Check the current AXIS OS version	37
Upgrade AXIS OS	37
Technical issues, clues and solutions	37
Performance considerations	39
Specifications	40
Product overview	40
LED indicators	40
SD card slot	41
Buttons	41
Connectors	41
API commands	44

AXIS C15 Series

Solution overview

Solution overview

This manual describes how you make the device accessible to your audio system, and how to configure the device directly from its interface (for instance when you use the device without an audio or video management software).

If you are using an audio or video management software, you can use that software for configuring the device. The following management software are available for controlling your audio system:

- **AXIS Audio Manager Edge** – Audio management software for small systems. Comes pre-installed on all audio devices with a firmware equal to or higher than 10.0.
 - *AXIS Audio Manager Edge user manual*
- **AXIS Audio Manager Pro** – Advanced audio management software for large systems.
 - *AXIS Audio Manager Pro user manual*
- **AXIS Camera Station** – Advanced video management software for large systems.
 - *AXIS Camera Station user manual*
- **AXIS Companion** – Video management software for small systems.
 - *AXIS Companion user manual*

For more information, see *Audio management software*.



To watch this video, go to the web version of this document.

help.axis.com/?&tpald=74869&tsection=solution-overview

An overview of how network audio works.

AXIS C15 Series

Installation

Installation



To watch this video, go to the web version of this document.

help.axis.com/?etpiald=74869&tsection=solution-overview

Download the installation guide (pdf):

- AXIS C1510 Network Pendant Speaker
axis.com/products/axis-c1510/support#support-resources
- AXIS C1511 Network Pendant Speaker
axis.com/products/axis-c1511/support#support-resources

AXIS C15 Series

Get started

Get started

Find the device on the network

To find Axis devices on the network and assign them IP addresses in Windows®, use AXIS IP Utility or AXIS Device Manager. Both applications are free and can be downloaded from axis.com/support.

For more information about how to find and assign IP addresses, go to *How to assign an IP address and access your device*.

Browser support

You can use the device with the following browsers:

	Chrome™	Firefox®	Edge™	Safari®
Windows®	recommended	recommended	✓	
macOS®	recommended	recommended	✓	✓
Linux®	recommended	recommended	✓	
Other operating systems	✓	✓	✓	✓*

*To use AXIS OS web interface with iOS 15 or iPadOS 15, go to **Settings > Safari > Advanced > Experimental Features** and disable *NSURLSession Websocket*.

If you need more information about recommended browsers, go to *AXIS OS Portal*.

Access the device

1. Open a browser and enter the IP address or host name of the Axis device.
2. Enter the username and password. If you access the device for the first time, you must set the root password. See *Set a new password for the root account on page 5*.

Set a new password for the root account

Important

The default administrator username is **root**. If the password for root is lost, reset the device to factory default settings. See *Reset to factory default settings on page 37*



To watch this video, go to the web version of this document.

help.axis.com/?&tpid=74869&tsection=set-a-new-password-for-the-root-account

Support tip: Password security confirmation check

1. Type a password. Follow the instructions about secure passwords. See *Secure passwords on page 6*.
2. Retype the password to confirm the spelling.

AXIS C15 Series

Get started

3. Click **Save**. The password has now been configured.

Secure passwords

Important

Axis devices send the initially set password in clear text over the network. To protect your device after the first login, set up a secure and encrypted HTTPS connection and then change the password.

The device password is the primary protection for your data and services. Axis devices do not impose a password policy as they may be used in various types of installations.

To protect your data we strongly recommend that you:

- Use a password with at least 8 characters, preferably created by a password generator.
- Don't expose the password.
- Change the password at a recurring interval, at least once a year.

AXIS C15 Series

Additional settings

Additional settings

Calibrate and run a remote speaker test

You can run a speaker test to verify from a remote location that a speaker is working as intended. The speaker performs the test by playing a series of test tones that are registered by the built-in microphone. Every time you run the test, the registered values are compared with the values that were registered during the calibration.

Note

The test must be calibrated from its mounted position at the installation site. If the speaker is moved or if its local surroundings change, for instance if a wall is built or removed, the speaker should be re-calibrated

During calibration, it is recommended that someone is physically present at the installation site to listen to the test tones and ensure that the test tones are not muffled or blocked by any unintended obstructions in the speaker's acoustic path.

1. Go to the device interface > **Audio** > **Speaker test**.
2. To calibrate the audio device, click **Calibrate**.

Note

Once the Axis product is calibrated, the speaker test can be run at any time.

3. To run the speaker test, click **Run the test**.

Note

It is also possible to run the calibration by pressing the control button on the physical device. See *Product overview on page 40* to identify the control button.

Set up direct SIP (P2P)

Use peer-to-peer when the communication is between a few user agents within the same IP network and there is no need for extra features that a PBX-server could provide. To better understand how P2P works, see *Peer-to-peer SIP (P2PSIP) on page 13*.

For more information about setting options, see *SIP on page 29*.

1. Go to **System** > **SIP** > **SIP settings** and select **Enable SIP**.
2. To allow the device to receive incoming calls, select **Allow incoming calls**.
3. Under **Call handling**, set the timeout and duration for the call.
4. Under **Ports**, enter the port numbers.
 - **SIP port** – The network port used for SIP communication. The signaling traffic through this port is non-encrypted. The default port number is 5060. Enter a different port number if required.
 - **TLS port** – The network port used for encrypted SIP communication. The signaling traffic through this port is encrypted with Transport Layer Security (TLS). The default port number is 5061. Enter a different port number if required.
 - **RTP start port** – Enter the port used for the first RTP media stream in a SIP call. The default start port for media transport is 4000. Some firewalls might block RTP traffic on certain port numbers. A port number must be between 1024 and 65535.
5. Under **NAT traversal**, select the protocols you want to enable for NAT traversal.

Note

Use NAT traversal when the device is connected to the network from behind a NAT router or a firewall. For more information see *NAT traversal on page 14*.

AXIS C15 Series

Additional settings

6. Under **Audio**, select at least one audio codec with the desired audio quality for SIP calls. Drag-and-drop to change the priority.
7. Under **Additional**, select additional options.
 - **UDP-to-TCP switching** – Select to allow calls to switch transport protocols from UDP (User Datagram Protocol) to TCP (Transmission Control Protocol) temporarily. The reason for switching is to avoid fragmentation, and the switch can take place if a request is within 200 bytes of the maximum transmission unit (MTU) or larger than 1300 bytes.
 - **Allow via rewrite** – Select to send the local IP address instead of the router's public IP address.
 - **Allow contact rewrite** – Select to send the local IP address instead of the router's public IP address.
 - **Register with server every** – Set how often you want the device to register with the SIP server for the existing SIP accounts.
 - **DTMF payload type** – Changes the default payload type for DTMF.
8. Click **Save**.

Set up SIP through a server (PBX)

Use a PBX-server when the communication should be between an infinite number of user agents within and outside the IP network. Additional features could be added to the setup depending on the PBX-provider. To better understand how P2P works, see *Private Branch Exchange (PBX)* on page 13.

For more information about setting options, see *SIP* on page 29.

1. Request the following information from your PBX provider:
 - User ID
 - Domain
 - Password
 - Authentication ID
 - Caller ID
 - Registrar
 - RTP start port
2. To add a new account, go to **System > SIP > SIP accounts** and click **+ Account**.
3. Enter the details you received from your PBX provider.
4. Select **Registered**.
5. Select a transport mode.
6. Click **Save**.
7. Set up the SIP settings the same way as for peer-to-peer. See *Set up direct SIP (P2P)* on page 7 for more information.

Set up rules for events

You can create rules to make your device perform actions when certain events occur. A rule consists of conditions and actions. The conditions can be used to trigger the actions. For example, the device can play an audio clip according to a schedule or when it receives a call, or send an email if the device changes IP address.

AXIS C15 Series

Additional settings

To learn more, check out our guide *Get started with rules for events*.

Send an email if a speaker test fails

In this example the audio device is configured to send an email to a defined recipient when a speaker test fails. The speaker test is configured to be performed 18:00 every day.

1. Set up a schedule for the speaker test:
 - 1.1 Go to the device interface > **System** > **Events** > **Schedules**.
 - 1.2 Create a schedule that starts at 18:00 and ends at 18:01 every day. Name it "Daily at 6pm".
2. Create an email recipient:
 - 2.1 Go to the device interface > **System** > **Events** > **Recipients**.
 - 2.2 Click **Add recipient**.
 - 2.3 Name the recipient "Speaker test recipients"
 - 2.4 Under **Type**, select **Email**.
 - 2.5 Under **Send email to**, enter the email addresses of the recipients. Use commas to separate multiple addresses.
 - 2.6 Enter the details for the email account of the sender.
 - 2.7 Click **Test** to send a test email.

Note

Some email providers have security filters that prevent users from receiving or viewing large attachments, from receiving scheduled emails and similar. Check the email provider's security policy to avoid delivery problems and locked email accounts.

- 2.8 Click **Save**.
3. Set up the automated speaker test:
 - 3.1 Go to the device interface > **System** > **Events** > **Rules**.
 - 3.2 Click **Add a rule**.
 - 3.3 Enter a name for the rule.
 - 3.4 Under **Condition**, select **Schedule** and select from the trigger list
 - 3.5 Under **Schedule**, select your schedule ("Daily at 6pm").
 - 3.6 Under **Action**, select **Run automatic speaker test**.
 - 3.7 Click **Save**.
4. Set up the condition for sending an email when the speaker test fails:
 - 4.1 Go to the device interface > **System** > **Events** > **Rules**.
 - 4.2 Click **Add a rule**.
 - 4.3 Enter a name for the rule.
 - 4.4 Under **Condition**, select **Speaker test result**.
 - 4.5 Under **Speaker test status**, select **Didn't pass the test**.
 - 4.6 Under **Action**, select **Send notification to email**.

AXIS C15 Series

Additional settings

- 4.7 Under **Recipient**, select your recipient ("Speaker test recipients")
- 4.8 Enter a subject and a message, and click **Save**.

Play audio when a camera detects motion

This example explains how to set up the audio device to play an audio clip when an Axis network camera detects motion.

Prerequisites

- The Axis audio device and Axis network camera are located on the same network.
- The motion detection application is configured and running in the camera.

1. Prepare an audio clip link:

- 1.1 Go to **Audio > Audio clips**.
- 1.2 Click  > **Create link** for an audio clip.
- 1.3 Set the volume and number of times to repeat the clip.
- 1.4 Click the copy icon to copy the link.

2. Create an action rule:

- 2.1 Go to **System > Events > Recipients**.
- 2.2 Click **+ Add recipient**.
- 2.3 Type a name for the recipient, for example "Speaker".
- 2.4 Select **HTTP** from the **Type** drop-down list.
- 2.5 Paste the configured link from the audio device in the **URL** field.
- 2.6 Enter the user name and password of the audio device.
- 2.7 Click **Save**.
- 2.8 Go to **Rules** and click **+ Add a rule**.
- 2.9 Type a name for the action rule, for example "Play clip".
- 2.10 From the **Condition** list, select a video motion detection alternative under **Applications**.

Note

If there are no options for video motion detection, then go to **Apps**, click **AXIS Video Motion Detection** and turn on motion detection.

- 2.11 From the **Action** list, select **Send notification through HTTP**.
- 2.12 Under **Recipient**, select your recipient.
- 2.13 Click **Save**.

Stop audio with DTMF

This example explains how to:

- Configure DTMF on a device.
- Set up an event to stop the audio when a DTMF command is sent to the device.

AXIS C15 Series

Additional settings

1. Go to **System > SIP > SIP settings**.
2. Make sure **Enable SIP** is turned on.
If you need to turn it on, remember to click **Save** afterwards.
3. Go to **SIP accounts**.
4. Next to the SIP account, click  > **Edit**.
5. Under **DTMF**, click **+ DTMF sequence**.
6. Under **Sequence**, enter "1".
7. Under **Description**, enter "stop audio".
8. Click **Save**.
9. Go to **System > Events > Rules** and click **+ Add a rule**.
10. Under **Name**, enter "DTMF stop audio".
11. Under **Condition**, select **DTMF**.
12. Under **DTMF Event ID**, select **stop audio**.
13. Under **Action**, select **Stop playing audio clip**.
14. Click **Save**.

Set up audio for incoming SIP calls

You can set up a rule that plays an audio clip when you receive a SIP call.

You can also set up an additional rule that answers the SIP call automatically after the audio clip has ended. This can be useful in cases where an alarm operator wants to call the attention of someone near an audio device and establish a line of communication. This is done by making a SIP call to the audio device, which will play an audio clip to alert the persons near the audio device. When the audio clip has stopped playing, the SIP call is automatically answered by the audio device and communication between the alarm operator and the persons near the audio device can take place.

Enable SIP settings:

1. Go to the device interface of the speaker, by entering its IP address in a web browser.
2. Go to **System > SIP > SIP settings** and select **Enable SIP**.
3. To allow the device to receive incoming calls, select **Allow incoming calls**.
4. Click **Save**.
5. Go to **SIP accounts**.
6. Next to the SIP account, click  > **Edit**.
7. Uncheck **Answer automatically**.

Play audio when a SIP call is received:

1. Go to **Settings > System > Events > Rules** and add a rule.
2. Type a name for the rule.
3. In the list of conditions, select **State**.

AXIS C15 Series

Additional settings

4. In the list of states, select **Ring**ing.
5. In the list of actions, select **Play audio clip**.
6. In the list of clips, select the audio clip you want to play.
7. Select how many times to repeat the audio clip. 0 means "play once".
8. Click **Save**.

Answer the SIP call automatically after the audio clip has ended:

1. Go to **Settings > System > Events > Rules** and add a rule.
2. Type a name for the rule.
3. In the list of conditions, select **Audio clip playing**.
4. Check **Use this condition as a trigger**.
5. Check **Invert this condition**.
6. Click **+ Add a condition** to add a second condition to the event.
7. In the list of conditions, select **State**.
8. In the list of states, select **Ring**ing.
9. In the list of actions, select **Answer call**.
10. Click **Save**.

AXIS C15 Series

Learn more

Learn more

Session Initiation Protocol (SIP)

The Session Initiation Protocol (SIP) is used to set up, maintain and terminate VoIP calls. You can make calls between two or more parties, called SIP user agents. To make a SIP call you can use, for example, SIP phones, softphones or SIP-enabled Axis devices.

The actual audio or video is exchanged between the SIP user agents with a transport protocol, for example RTP (Real-Time Transport Protocol).

You can make calls on local networks using a peer-to-peer setup, or across networks using a PBX.

Peer-to-peer SIP (P2PSIP)

The most basic type of SIP communication takes place directly between two or more SIP user agents. This is called peer-to-peer SIP (P2PSIP). If it takes place on a local network, all that's needed are the SIP addresses of the user agents. A typical SIP address in this case would be `sip:<local-ip>`.

Example:

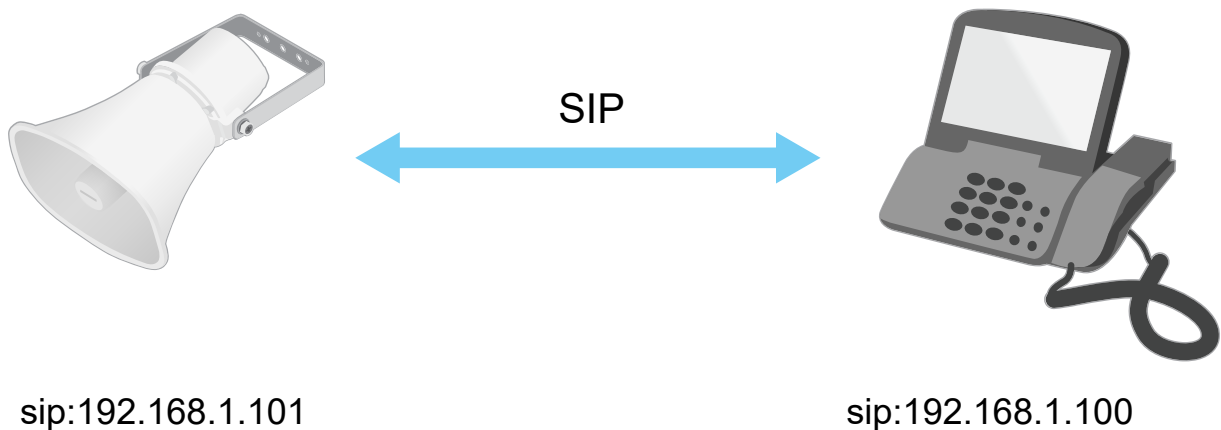

You can set up a SIP-enabled phone to call an audio device on the same network using a peer-to-peer SIP setup.

Private Branch Exchange (PBX)

When you make SIP calls outside your local IP network, a Private Branch Exchange (PBX) can act as a central hub. The main component of a PBX is a SIP server, which is also referred to as a SIP proxy or a registrar. A PBX works like a traditional switchboard, showing the client's current status and allowing for example call transfers, voicemail, and redirections.

The PBX SIP server can be set up as a local entity or offsite. It can be hosted on an intranet or by a third party provider. When you make SIP calls between networks, calls are routed through a set of PBXs, that query the location of the SIP address to be reached.

Each SIP user agent registers with the PBX, and can then reach the others by dialing the correct extension. A typical SIP address in this case would be `sip:<user>@<domain>` or `sip:<user>@<registrar-ip>`. The SIP address is independent of its IP address and the PBX makes the device accessible as long as it is registered to the PBX.

Example:

AXIS C15 Series

Learn more

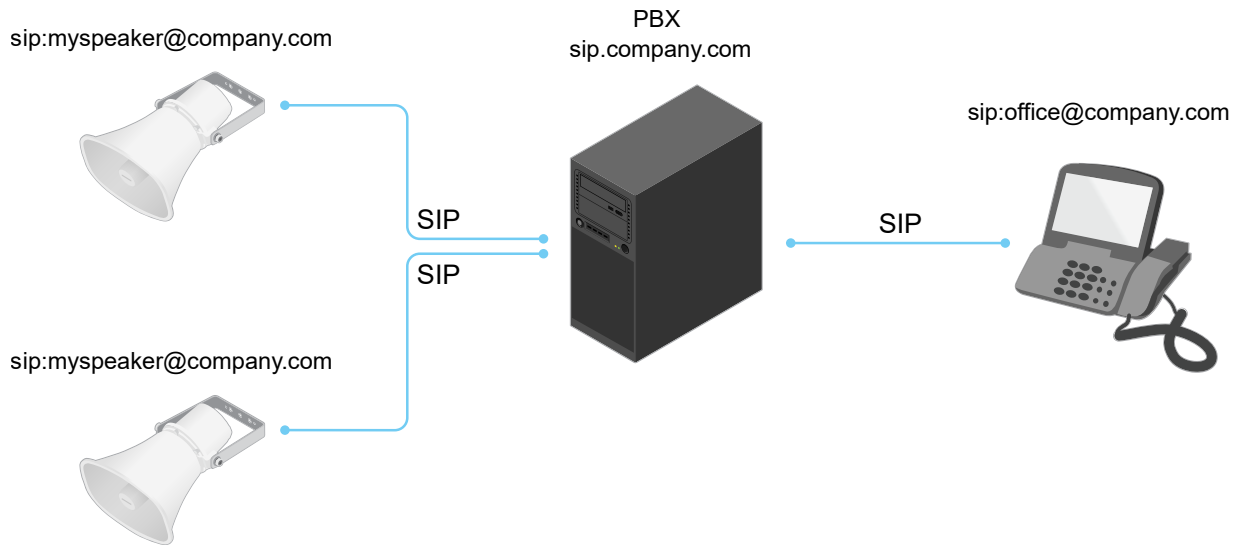

NAT traversal

Use NAT (Network Address Translation) traversal when the Axis device is located on an private network (LAN) and you want to access it from outside of that network.

Note

The router must support NAT traversal and UPnP®.

Each NAT traversal protocol can be used separately or in different combinations depending on the network environment.

- **ICE** The ICE (Interactive Connectivity Establishment) protocol increases the chances of finding the most efficient path to successful communication between peer devices. If you also enable STUN and TURN, you improve the ICE protocol's chances.
- **STUN** - STUN (Session Traversal Utilities for NAT) is a client-server network protocol that lets the Axis device determine if it is located behind a NAT or firewall, and if so obtain the mapped public IP address and port number allocated for connections to remote hosts. Enter the STUN server address, for example, an IP address.
- **TURN** - TURN (Traversal Using Relays around NAT) is a protocol that lets a device behind a NAT router or firewall receive incoming data from other hosts over TCP or UDP. Enter TURN server address and the login information.

Applications

With applications, you can get more out of your Axis device. AXIS Camera Application Platform (ACAP) is an open platform that makes it possible for third parties to develop analytics and other applications for Axis devices. Applications can be preinstalled on the device, available for download for free, or for a license fee.









To find the user manuals for Axis applications, go to help.axis.com.

AXIS C15 Series

The web interface

The web interface

To reach the device's web interface, type the device's IP address in a web browser.

	Show or hide the main menu.		Access the release notes.		Access the product help.		Change the language.
	Set light theme or dark theme.		The user menu contains:				
	<ul style="list-style-type: none">Information about the user who is logged in. Change account : Log out from the current account and log in to a new account. Log out : Log out from the current account.		The context menu contains:				
	<ul style="list-style-type: none">Analytics data: Accept to share non-personal browser data.Feedback: Share any feedback to help us improve your user experience.Legal: View information about cookies and licenses.About: View device information, including AXIS OS version and serial number.						

Status

Audio system info

This information is only shown for devices that belong to an AXIS Audio Manager Edge site.

AXIS Audio Manager Edge : Launch AXIS Audio Manager Edge.
--

Locate device

Shows the locate device information, including serial number and IP address.

Locate device : Plays a sound that helps you identify the speaker. For some products, the device will flash a LED.

Speaker test

Shows whether the speaker has been calibrated or not.

Speaker test :  : Calibrate the speaker. Takes you to the Speaker test page where you can do the calibration and run the speaker test.

Device info

Shows the device information, including AXIS OS version and serial number.

Upgrade AXIS OS : Upgrade the software on your device. Takes you to the Maintenance page where you can do the upgrade.

Time sync status

Shows NTP synchronization information, including if the device is in sync with an NTP server and the time remaining until the next sync.

NTP settings : View and update the NTP settings. Takes you to the Time and location page where you can change the NTP settings.

AXIS C15 Series

The web interface

Security

Shows what kind of access to the device that is active, what encryption protocols are in use, and if unsigned apps are allowed. Recommendations to the settings are based on the AXIS OS Hardening Guide.

Hardening guide: Link to *AXIS OS Hardening guide* where you can learn more about cybersecurity on Axis devices and best practices.

Connected clients

Shows the number of connections and connected clients.

View details: View and update the list of connected clients. The list shows IP address, protocol, port, state, and PID/process of each connection.

Ongoing recordings

Shows ongoing recordings and their designated storage space.

Recordings: View ongoing and filtered recordings and their source. For more information, see *Recordings on page 17* 



Shows the storage space where the recording is saved.

Audio



AXIS Audio Manager Edge

AXIS Audio Manager Edge: Launch the application.

Audio site security

CA certificate: Select the certificate to use when you add devices to the audio site. You have to enable TLS authentication in AXIS Audio Manager Edge. **Save:** Activate and save your selection.

Device settings

Input: Turn on or off audio input. Shows the type of input. **Gain:** Use the slider to change the gain. Click the microphone icon to mute or unmute. **Input type**  : Select the type of input. **Power type**  : Select the type of power.

Output: Shows the type of output.

Gain: Use the slider to change the gain. Click the speaker icon to mute or unmute.

Stream



Encoding: Select the encoding to use for the input source streaming. You can only choose encoding if audio input is turned on. If audio input is turned off, click **Enable audio input** to turn it on.

Echo cancellation: Turn on to remove echoes during two-way communication.

AXIS C15 Series

The web interface



Audio clips

 Add clip: Add a new audio clip. You can use .au, .mp3, .opus, .vorbis, .wav files.  Play the audio clip.  Stop

playing the audio clip.  The context menu contains:

- **Rename:** Change the name of the audio clip.
- **Create link:** Create a URL that, when used, plays the audio clip on the device. Specify the volume and number of times to play the clip.
- **Download:** Download the audio clip to your computer.
- **Delete:** Delete the audio clip from the device.

Listen and record

 Click to listen.  Start a continuous recording of the live audio stream. Click again to stop the recording. If a recording is ongoing, it will resume automatically after a reboot.

Note



You can only listen and record if input is turned on for the device. Go to **Audio > Device settings** to make sure you turn on input.



 Shows the configured storage for the device. To configure the storage, you need to be logged in as an administrator.





Speaker test

You can use the speaker test to verify remotely that the speaker works as intended. **Calibrate:** You need to calibrate the speaker before its first test. During calibration, the speaker plays a series of test tones that are registered by the built-in microphone. When you calibrate the speaker, it must be installed in its final position. If you move the speaker later, or if its surroundings change, for example, if a wall is built or removed, you need to recalibrate the speaker. **Run the test:** Play the same series of test tones that were played during calibration, and compare them with the calibration's registered values.

Recordings

 Click to filter the recordings. **From:** Show recordings done after a certain point in time. **To:** Show recordings up until a certain point in time. **Source**  : Show recordings based on source. The source refers to the sensor. **Event:** Show recordings based on events. **Storage:** Show recordings based on storage type.





Ongoing recordings: Show all ongoing recordings on the device.  Start a recording on the device.  Choose which storage device to save to.  Stop a recording on the device. **Triggered recordings** will end when manually stopped or when the device is shut down. **Continuous recordings** will continue until manually stopped. Even if the device is shut down, the recording will continue when the device starts up again.

 Play the recording.  Stop playing the recording.   Show or hide information and options about the recording. **Set export range:** If you only want to export part of the recording, enter a time span. Note that if you work in a different time zone than the location of the device, the time span is based on the device's time zone. **Encrypt:** Select to set a password for exported recordings. It will not be possible to open the exported file without the password.  Click to delete a recording. **Export:** Export the whole or a part of the recording.

AXIS C15 Series

The web interface

Apps

 **Add app:** Install a new app. **Find more apps:** Find more apps to install. You will be taken to an overview page of Axis apps. **Allow unsigned apps**  : Turn on to allow installation of unsigned apps. **Allow root-privileged apps**  : Turn on to allow apps with root privileges full access to the device.  View the security updates in AXIS OS and ACAP apps.

Note

The device's performance might be affected if you run several apps at the same time.

Use the switch next to the app name to start or stop the app. **Open:** Access the app's settings. The available settings depend on the application. Some applications don't have any settings.  The context menu can contain one or more of the following options:

- **Open-source license:** View information about open-source licenses used in the app.
- **App log:** View a log of the app events. The log is helpful when you contact support.
- **Activate license with a key:** If the app requires a license, you need to activate it. Use this option if your device doesn't have internet access. If you don't have a license key, go to axis.com/products/analytics. You need a license code and the Axis product serial number to generate a license key.
- **Activate license automatically:** If the app requires a license, you need to activate it. Use this option if your device has internet access. You need a license code to activate the license.
- **Deactivate the license:** Deactivate the license to replace it with another license, for example, when you change from a trial license to a full license. If you deactivate the license, you also remove it from the device.
- **Settings:** Configure the parameters.
- **Delete:** Delete the app permanently from the device. If you don't deactivate the license first, it remains active.

System

Time and location

Date and time

The time format depends on the web browser's language settings.

Note

We recommend you synchronize the device's date and time with an NTP server.

Synchronization: Select an option for the device's date and time synchronization.

- **Automatic date and time (manual NTS KE servers):** Synchronize with the secure NTP key establishment servers connected to the DHCP server.
 - **Manual NTS KE servers:** Enter the IP address of one or two NTP servers. When you use two NTP servers, the device synchronizes and adapts its time based on input from both.
 - **Max NTP poll time:** Select the maximum amount of time the device should wait before it polls the NTP server to get an updated time.
 - **Min NTP poll time:** Select the minimum amount of time the device should wait before it polls the NTP server to get an updated time.
- **Automatic date and time (NTP servers using DHCP):** Synchronize with the NTP servers connected to the DHCP server.
 - **Fallback NTP servers:** Enter the IP address of one or two fallback servers.
 - **Max NTP poll time:** Select the maximum amount of time the device should wait before it polls the NTP server to get an updated time.
 - **Min NTP poll time:** Select the minimum amount of time the device should wait before it polls the NTP server to get an updated time.
- **Automatic date and time (manual NTP servers):** Synchronize with NTP servers of your choice.
 - **Manual NTP servers:** Enter the IP address of one or two NTP servers. When you use two NTP servers, the device synchronizes and adapts its time based on input from both.

AXIS C15 Series

The web interface

- **Max NTP poll time:** Select the maximum amount of time the device should wait before it polls the NTP server to get an updated time.
 - **Min NTP poll time:** Select the minimum amount of time the device should wait before it polls the NTP server to get an updated time.
 - **Custom date and time:** Manually set the date and time. Click **Get from system** to fetch the date and time settings once from your computer or mobile device.
- Time zone:** Select which time zone to use. Time will automatically adjust to daylight saving time and standard time.
- **DHCP:** Adopts the time zone of the DHCP server. The device must be connected to a DHCP server before you can select this option.
 - **Manual:** Select a time zone from the drop-down list.

Note

The system uses the date and time settings in all recordings, logs, and system settings.

Device location

Enter where the device is located. Your video management system can use this information to place the device on a map.

- **Latitude:** Positive values are north of the equator.
- **Longitude:** Positive values are east of the prime meridian.
- **Heading:** Enter the compass direction that the device is facing. 0 is due north.
- **Label:** Enter a descriptive name for the device.
- **Save:** Click to save your device location.

Network

IPv4

Assign IPv4 automatically: Select to let the network router assign an IP address to the device automatically. We recommend automatic IP (DHCP) for most networks.**IP address:** Enter a unique IP address for the device. Static IP addresses can be assigned at random within isolated networks, provided that each address is unique. To avoid conflicts, we recommend you contact your network administrator before you assign a static IP address.**Subnet mask:** Enter the subnet mask to define what addresses are inside the local area network. Any address outside the local area network goes through the router.**Router:** Enter the IP address of the default router (gateway) used to connect devices that are attached to different networks and network segments.**Fallback to static IP address if DHCP isn't available:** Select if you want to add a static IP address to use as fallback if DHCP is unavailable and can't assign an IP address automatically.

Note

If DHCP isn't available and the device uses a static address fallback, the static address is configured with a limited scope.

IPv6

Assign IPv6 automatically: Select to turn on IPv6 and to let the network router assign an IP address to the device automatically.

Hostname

Assign hostname automatically: Select to let the network router assign a hostname to the device automatically.**Hostname:** Enter the hostname manually to use as an alternative way of accessing the device. The server report and system log use the hostname. Allowed characters are A-Z, a-z, 0-9 and -.**Enable dynamic DNS updates:** Allow your device to automatically update its domain name server records whenever its IP address changes.**Register DNS name:** Enter a unique domain name that points to your device's IP address. Allowed characters are A-Z, a-z, 0-9 and -.**TTL:** Time to Live (TTL) sets how long a DNS record stays valid before it needs to be updated.

DNS servers

Assign DNS automatically: Select to let the DHCP server assign search domains and DNS server addresses to the device automatically. We recommend automatic DNS (DHCP) for most networks.**Search domains:** When you use a hostname that is not fully qualified, click **Add search domain** and enter a domain in which to search for the hostname the device uses.**DNS servers:** Click **Add DNS server** and enter the IP address of the DNS server. This provides the translation of hostnames to IP addresses on your network.

AXIS C15 Series

The web interface

HTTP and HTTPS

HTTPS is a protocol that provides encryption for page requests from users and for the pages returned by the web server. The encrypted exchange of information is governed by the use of an HTTPS certificate, which guarantees the authenticity of the server.

To use HTTPS on the device, you must install an HTTPS certificate. Go to **System > Security** to create and install certificates.

Allow access through: Select if a user is allowed to connect to the device through the HTTP, HTTPS, or both HTTP and HTTPS protocols.

Note

If you view encrypted web pages through HTTPS, you might experience a drop in performance, especially when you request a page for the first time.

HTTP port: Enter the HTTP port to use. The device allows port 80 or any port in the range 1024–65535. If you are logged in as an administrator, you can also enter any port in the range 1–1023. If you use a port in this range, you get a warning.**HTTPS port:** Enter the HTTPS port to use. The device allows port 443 or any port in the range 1024–65535. If you are logged in as an administrator, you can also enter any port in the range 1–1023. If you use a port in this range, you get a warning.**Certificate:** Select a certificate to enable HTTPS for the device.

Network discovery protocols

Bonjour®: Turn on to allow automatic discovery on the network.**Bonjour name:** Enter a friendly name to be visible on the network. The default name is the device name and MAC address.**UPnP®:** Turn on to allow automatic discovery on the network.**UPnP name:** Enter a friendly name to be visible on the network. The default name is the device name and MAC address.**WS-Discovery:** Turn on to allow automatic discovery on the network.**LLDP and CDP:** Turn on to allow automatic discovery on the network. Turning LLDP and CDP off can impact the PoE power negotiation. To resolve any issues with the PoE power negotiation, configure the PoE switch for hardware PoE power negotiation only.

Global proxies

Http proxy: Specify a global proxy host or IP address according to the allowed format.**Https proxy:** Specify a global proxy host or IP address according to the allowed format.

Allowed formats for http and https proxies:

- http(s)://host:port
- http(s)://user@host:port
- http(s)://user:pass@host:port

Note

Restart the device to apply the global proxy settings.

No proxy: Use **No proxy** to bypass global proxies. Enter one of the options in the list, or enter several separated by a comma:

- Leave empty
- Specify an IP address
- Specify an IP address in CIDR format
- Specify a domain name, for example: www.<domain name>.com
- Specify all subdomains in a specific domain, for example .<domain name>.com

One-click cloud connection

One-click cloud connection (O3C) together with an O3C service provides easy and secure internet access to live and recorded video from any location. For more information, see axis.com/end-to-end-solutions/hosted-services.

AXIS C15 Series

The web interface

Allow O3C:

- **One-click:** This is the default setting. Press and hold the control button on the device to connect to an O3C service over the internet. You need to register the device with the O3C service within 24 hours after you press the control button. Otherwise, the device disconnects from the O3C service. Once you register the device, **Always** is enabled and the device stays connected to the O3C service.
- **Always:** The device constantly attempts to connect to an O3C service over the internet. Once you register the device, it stays connected to the O3C service. Use this option if the control button on the device is out of reach.
- **No:** Disables the O3C service.

Proxy settings: If needed, enter the proxy settings to connect to the proxy server. **Host:** Enter the proxy server's address. **Port:** Enter the port number used for access. **Login and Password:** If needed, enter username and password for the proxy server. **Authentication method:**

- **Basic:** This method is the most compatible authentication scheme for HTTP. It's less secure than the **Digest** method because it sends the username and password unencrypted to the server.
- **Digest:** This method is more secure because it always transfers the password encrypted across the network.
- **Auto:** This option lets the device select the authentication method depending on the supported methods. It prioritizes the **Digest** method over the **Basic** method.

Owner authentication key (OAK): Click **Get key** to fetch the owner authentication key. This is only possible if the device is connected to the internet without a firewall or proxy.

SNMP

The Simple Network Management Protocol (SNMP) allows remote management of network devices.

SNMP: Select the version of SNMP to use.

- **v1 and v2c:**
 - **Read community:** Enter the community name that has read-only access to all supported SNMP objects. The default value is **public**.
 - **Write community:** Enter the community name that has read or write access to all supported SNMP objects (except read-only objects). The default value is **write**.
 - **Activate traps:** Turn on to activate trap reporting. The device uses traps to send messages for important events or status changes to a management system. In the web interface, you can set up traps for SNMP v1 and v2c. Traps are automatically turned off if you change to SNMP v3 or turn off SNMP. If you use SNMP v3, you can set up traps through the SNMP v3 management application.
 - **Trap address:** Enter the IP address or host name of the management server.
 - **Trap community:** Enter the community to use when the device sends a trap message to the management system.
 - **Traps:**
 - **Cold start:** Sends a trap message when the device starts.
 - **Warm start:** Sends a trap message when you change an SNMP setting.
 - **Link up:** Sends a trap message when a link changes from down to up.
 - **Authentication failed:** Sends a trap message when an authentication attempt fails.

Note

All Axis Video MIB traps are enabled when you turn on SNMP v1 and v2c traps. For more information, see *AXIS OS Portal > SNMP*.

- **v3:** SNMP v3 is a more secure version, which provides encryption and secure passwords. To use SNMP v3, we recommend you to activate HTTPS, as the password is then sent through HTTPS. This also prevents unauthorized parties' access to unencrypted SNMP v1 and v2c traps. If you use SNMP v3, you can set up traps through the SNMP v3 management application.
 - **Password for the account "initial":** Enter the SNMP password for the account named "initial". Although the password can be sent without activating HTTPS, we don't recommend it. The SNMP v3 password can only be set once, and preferably only when HTTPS is enabled. Once the password is set, the password field is no longer displayed. To set the password again, you must reset the device to factory default settings.

Security

Certificates

AXIS C15 Series

The web interface

Certificates are used to authenticate devices on a network. The device supports two types of certificates:

- **Client/server certificates**
A client/server certificate validates the device's identity, and can be self-signed or issued by a Certificate Authority (CA). A self-signed certificate offers limited protection and can be used before a CA-issued certificate has been obtained.
- **CA certificates**
You can use a CA certificate to authenticate a peer certificate, for example to validate the identity of an authentication server when the device connects to a network protected by IEEE 802.1X. The device has several pre-installed CA certificates.

These formats are supported:

- Certificate formats: .PEM, .CER, and .PFX
- Private key formats: PKCS#1 and PKCS#12

Important

If you reset the device to factory default, all certificates are deleted. Any pre-installed CA certificates are reinstalled.



Add certificate : Click to add a certificate.

- **More**  : Show more fields to fill in or select.
- **Secure keystore**: Select to use **Secure element** or **Trusted Platform Module 2.0** to securely store the private key. For more information on which secure keystore to select, go to help.axis.com/en-us/axis-os#cryptographic-support.
- **Key type**: Select the default or a different encryption algorithm from the drop-down list to protect the certificate.



The context menu contains:

- **Certificate information**: View an installed certificate's properties.
- **Delete certificate**: Delete the certificate.
- **Create certificate signing request**: Create a certificate signing request to send to a registration authority to apply for a digital identity certificate.

Secure keystore  :

- **Secure element (CC EAL6+)**: Select to use secure element for secure keystore.
- **Trusted Platform Module 2.0 (CC EAL4+, FIPS 140-2 Level 2)**: Select to use TPM 2.0 for secure keystore.

Network access control and encryption

IEEE 802.1x IEEE 802.1x is an IEEE standard for port-based network admission control providing secure authentication of wired and wireless network devices. IEEE 802.1x is based on EAP (Extensible Authentication Protocol). To access a network protected by IEEE 802.1x, network devices must authenticate themselves. The authentication is performed by an authentication server, typically a RADIUS server (for example, FreeRADIUS and Microsoft Internet Authentication Server). **IEEE 802.1AE MACsec** IEEE 802.1AE MACsec is an IEEE standard for media access control (MAC) security that defines connectionless data confidentiality and integrity for media access independent protocols. **Certificates** When configured without a CA certificate, server certificate validation is disabled and the device tries to authenticate itself regardless of what network it is connected to. When using a certificate, in Axis' implementation, the device and the authentication server authenticate themselves with digital certificates using EAP-TLS (Extensible Authentication Protocol - Transport Layer Security). To allow the device to access a network protected through certificates, you must install a signed client certificate on the device. **Authentication method**: Select an EAP type used for authentication. **Client certificate**: Select a client certificate to use IEEE 802.1x. The authentication server uses the certificate to validate the client's identity. **CA certificates**: Select CA certificates to validate the authentication server's identity. When no certificate is selected, the device tries to authenticate itself regardless of what network it is connected to. **EAP identity**: Enter the user identity associated with the client certificate. **EAPOL version**: Select the EAPOL version that is used in the network switch. Use **IEEE 802.1x**: Select to use the IEEE 802.1x protocol. These settings are only available if you use IEEE 802.1x PEAP-MSCHAPv2 as the authentication method:

- **Password**: Enter the password for your user identity.
- **Peap version**: Select the Peap version that is used in the network switch.
- **Label**: Select 1 to use client EAP encryption; select 2 to use client PEAP encryption. Select the Label that the network switch uses when using Peap version 1.

These settings are only available if you use **IEEE 802.1ae MACsec (Static CAK/Pre-Shared Key)** as the authentication method:

- **Key agreement connectivity association key name**: Enter the connectivity association name (CKN). It must be 2 to 64 (divisible by 2) hexadecimal characters. The CKN must be manually configured in the connectivity association and must match on both ends of the link to initially enable MACsec.

AXIS C15 Series

The web interface

- **Key agreement connectivity association key:** Enter the connectivity association key (CAK). It should be either 32 or 64 hexadecimal characters long. The CAK must be manually configured in the connectivity association and must match on both ends of the link to initially enable MACsec.

Prevent brute-force attacks

Blocking: Turn on to block brute-force attacks. A brute-force attack uses trial-and-error to guess login info or encryption keys. **Blocking period:** Enter the number of seconds to block a brute-force attack. **Blocking conditions:** Enter the number of authentication failures allowed per second before the block starts. You can set the number of failures allowed both on page level and device level.

Firewall

Activate: Turn on the firewall.

Default Policy: Select the default state for the firewall.

- **Allow:** Allows all connections to the device. This option is set by default.
- **Deny:** Denies all connections to the device.

To make exceptions to the default policy, you can create rules that allows or denies connections to the device from specific addresses, protocols, and ports.

- **Address:** Enter an address in IPv4/IPv6 or CIDR format that you want to allow or deny access to.
- **Protocol:** Select a protocol that you want to allow or deny access to.
- **Port:** Enter a port number that you want to allow or deny access to. You can add a port number between 1 and 65535.
- **Policy:** Select the policy of the rule.



: Click to create another rule.

Add rules: Click to add the rules that you have defined.

- **Time in seconds:** Set a time limit for testing the rules. The default time limit is set to 300 seconds. To activate the rules straight away, set the time to 0 seconds.
- **Confirm rules:** Confirm the rules and their time limit. If you have set a time limit of more than 1 second, the rules will be active during this time. If you have set the time to 0, the rules will be active straight away.

Pending rules: An overview of the latest tested rules that you are yet to confirm.

Note

The rules that have a time limit appear under **Active** rules until the displayed timer runs out, or until you confirm them. If you don't confirm them, they will appear under **Pending** rules once the timer runs out, and the firewall will revert to the previously defined settings. If you confirm them, they will replace the current active rules.

Confirm rules: Click to activate the pending rules. **Active rules:** An overview of the rules you are currently running on the device.



: Click to delete an active rule.



: Click to delete all rules, both pending and active.

Custom signed AXIS OS certificate

To install test software or other custom software from Axis on the device, you need a custom signed AXIS OS certificate. The certificate verifies that the software is approved by both the device owner and Axis. The software can only run on a specific device which is identified by its unique serial number and chip ID. Only Axis can create custom signed AXIS OS certificates, since Axis holds the key to sign them. **Install:** Click to install the certificate. You need to install the certificate before you install the

software.  The context menu contains:

- **Delete certificate:** Delete the certificate.

Accounts

Accounts

AXIS C15 Series

The web interface

 **Add account:** Click to add a new account. You can add up to 100 accounts. **Account:** Enter a unique account name. **New password:** Enter a password for the account. Passwords must be 1 to 64 characters long. Only ASCII printable characters (code 32 to 126) are allowed in the password, for example, letters, numbers, punctuation, and some symbols. **Repeat password:** Enter the same password again. **Privileges:**

- **Administrator:** Has full access to all settings. Administrators can also add, update, and remove other accounts.
- **Operator:** Has access to all settings except:
 - All **System** settings.
- **Viewer:** Doesn't have access to change any settings.

⋮ The context menu contains: **Update account:** Edit the account properties. **Delete account:** Delete the account. You can't delete the root account.

Anonymous access

Allow anonymous viewing: Turn on to allow anyone access the device as a viewer without logging in with an account. **Allow anonymous PTZ operating**  : Turn on to allow anonymous users to pan, tilt, and zoom the image.

SSH accounts

 **Add SSH account:** Click to add a new SSH account.

- **Restrict root access:** Turn on to restrict functionality that requires root access.
- **Enable SSH:** Turn on to use SSH service.

Account: Enter a unique account name. **New password:** Enter a password for the account. Passwords must be 1 to 64 characters long. Only ASCII printable characters (code 32 to 126) are allowed in the password, for example, letters, numbers, punctuation, and some symbols. **Repeat password:** Enter the same password again. **Comment:** Enter a comment (optional). ⋮ The context menu contains: **Update SSH account:** Edit the account properties. **Delete SSH account:** Delete the account. You can't delete the root account.

Virtual host

 **Add virtual host:** Click to add a new virtual host. **Enabled:** Select to use this virtual host. **Server name:** Enter the name of the server. Only use numbers 0-9, letters A-Z, and hyphen (-). **Port:** Enter the port the server is connected to. **Type:** Select the type of authentication to use. Select between **Basic**, **Digest**, and **Open ID**. ⋮ The context menu contains:

- **Update:** Update the virtual host.
- **Delete:** Delete the virtual host.

Disabled: The server is disabled.

OpenID Configuration

Important

If you can't use OpenID to sign in, use the Digest or Basic credentials you used when you configured OpenID to sign in.

Client ID: Enter the OpenID username. **Outgoing Proxy:** Enter the proxy address for the OpenID connection to use a proxy server. **Admin claim:** Enter a value for the admin role. **Provider URL:** Enter the web link for the API endpoint authentication. Format should be `https://[insert URL]/well-known/openid-configuration` **Operator claim:** Enter a value for the operator role. **Require claim:** Enter the data that should be in the token. **Viewer claim:** Enter the value for the viewer role. **Remote user:** Enter a value to identify remote users. This assists to display the current user in the device's web interface. **Scopes:** Optional scopes that could be part of the token. **Client secret:** Enter the OpenID password **Save:** Click to save the OpenID values. **Enable OpenID:** Turn on to close current connection and allow device authentication from the provider URL.

AXIS C15 Series

The web interface

Events

Rules

A rule defines the conditions that triggers the product to perform an action. The list shows all the currently configured rules in the product.

Note

You can create up to 256 action rules.



Add a rule: Create a rule. **Name:** Enter a name for the rule. **Wait between actions:** Enter the minimum time (hh:mm:ss) that must pass between rule activations. It is useful if the rule is activated by, for example, day-night mode conditions, to avoid that small light changes during sunrise and sunset activate the rule repeatedly. **Condition:** Select a condition from the list. A condition must be met for the device to perform an action. If multiple conditions are defined, all of them must be met to trigger the action. For information about specific conditions, see *Get started with rules for events*. **Use this condition as a trigger:** Select to make this first condition function only as a starting trigger. It means that once the rule is activated, it remains active for as long as all the other conditions are met, no matter the state of the first condition. If you don't select this option, the rule will simply be active whenever all the conditions are met. **Invert this condition:** Select if you want the condition to be the opposite of your



selection. **Add a condition:** Click to add an additional condition. **Action:** Select an action from the list and enter its required information. For information about specific actions, see *Get started with rules for events*.

Your product may have some of the following pre-configured rules: **Front-facing LED Activation: LiveStream:** When the microphone is turned on and a live stream is received, then the front-facing LED on the audio device will turn green. **Front-facing LED Activation: Recording :** When the microphone is turned on and a recording is ongoing, then the front-facing LED on the audio device will turn green. **Front-facing LED Activation: SIP :** When the microphone is turned on and a SIP call is active, then the front-facing LED on the audio device will turn green. You must enable SIP on the audio device before it can trigger this event. **Pre-announcement tone: Play tone on incoming call:** When a SIP call is made to the audio device, then the device plays a pre-defined audio clip. You must enable SIP for the audio device. For the SIP caller to hear a ring tone while the audio device plays the audio clip, you must configure the SIP account for the device to not answer the call automatically. **Pre-announcement tone: Answer call after incoming call-tone:** When the audio clip has ended, the incoming SIP-call is answered. You must enable SIP for the audio device. **Loud ringer :** When a SIP call is made to the audio device, a pre-defined audio clip is played as long as the rule is active. You must enable SIP for the audio device.

Recipients

You can set up your device to notify recipients about events or send files.

Note

If you set up your device to use FTP or SFTP, don't change or remove the unique sequence number that's added to the file names. If you do that, only one image per event can be sent.



The list shows all the recipients currently configured in the product, along with information about their configuration.

Note

You can create up to 20 recipients.



Add a recipient: Click to add a recipient. **Name:** Enter a name for the recipient. **Type:** Select from the list:

-  **FTP**
 - **Host:** Enter the server's IP address or hostname. If you enter a hostname, make sure that a DNS server is specified under **System > Network > IPv4 and IPv6**.
 - **Port:** Enter the port number used by the FTP server. The default is 21.
 - **Folder:** Enter the path to the directory where you want to store files. If this directory doesn't already exist on the FTP server, you will get an error message when uploading files.
 - **Username:** Enter the username for the login.
 - **Password:** Enter the password for the login.
 - **Use temporary file name:** Select to upload files with temporary, automatically generated filenames. The files get renamed to the desired names when the upload completes. If the upload is aborted/interrupted, you don't get any corrupt files. However, you probably still get the temporary files. This way you know that all files that have the desired name are correct.
 - **Use passive FTP:** Under normal circumstances, the product simply requests the target FTP server to open the data connection. The device actively initiates both the FTP control and data connections to the target server. This is normally needed if there is a firewall between the device and the target FTP server.
- **HTTP**
 - **URL:** Enter the network address to the HTTP server and the script that will handle the request. For example, `http://192.168.254.10/cgi-bin/notify.cgi`.
 - **Username:** Enter the username for the login.
 - **Password:** Enter the password for the login.
 - **Proxy:** Turn on and enter the required information if a proxy server must be passed to connect to the HTTP server.
- **HTTPS**
 - **URL:** Enter the network address to the HTTPS server and the script that will handle the request. For example, `https://192.168.254.10/cgi-bin/notify.cgi`.
 - **Validate server certificate:** Select to validate the certificate that was created by HTTPS server.
 - **Username:** Enter the username for the login.
 - **Password:** Enter the password for the login.
 - **Proxy:** Turn on and enter the required information if a proxy server must be passed to connect to the HTTPS server.
-  **Network storage**

You can add network storage such as NAS (network-attached storage) and use it as a recipient to store files. The files are stored in the Matroska (MKV) file format.

 - **Host:** Enter the IP address or hostname for the network storage.
 - **Share:** Enter the name of the share on the host.
 - **Folder:** Enter the path to the directory where you want to store files.
 - **Username:** Enter the username for the login.
 - **Password:** Enter the password for the login.
-  **SFTP**
 - **Host:** Enter the server's IP address or hostname. If you enter a hostname, make sure that a DNS server is specified under **System > Network > IPv4 and IPv6**.
 - **Port:** Enter the port number used by the SFTP server. The default is 22.
 - **Folder:** Enter the path to the directory where you want to store files. If this directory doesn't already exist on the SFTP server, you will get an error message when uploading files.
 - **Username:** Enter the username for the login.
 - **Password:** Enter the password for the login.
 - **SSH host public key type (MD5):** Enter the fingerprint of the remote host's public key (a 32-digit hexadecimal string). The SFTP client supports SFTP servers using SSH-2 with RSA, DSA, ECDSA, and ED25519 host key types. RSA is the preferred method during negotiation, followed by ECDSA, ED25519, and DSA. Make sure to enter the right MD5 host key that is used by your SFTP server. While the Axis device supports both MD5 and SHA-256 hash keys, we recommend using SHA-256 due to stronger security over MD5. For more information on how to configure an SFTP server with an Axis device, go to the *AXIS OS Portal*.
 - **SSH host public key type (SHA256):** Enter the fingerprint of the remote host's public key (a 43-digit Base64 encoded string). The SFTP client supports SFTP servers using SSH-2 with RSA, DSA, ECDSA, and ED25519 host key types. RSA is the preferred method during negotiation, followed by ECDSA, ED25519, and DSA. Make

AXIS C15 Series

The web interface

sure to enter the right MD5 host key that is used by your SFTP server. While the Axis device supports both MD5 and SHA-256 hash keys, we recommend using SHA-256 due to stronger security over MD5. For more information on how to configure an SFTP server with an Axis device, go to the *AXIS OS Portal*.

- **Use temporary file name:** Select to upload files with temporary, automatically generated filenames. The files get renamed to the desired names when the upload completes. If the upload is aborted or interrupted, you don't get any corrupt files. However, you probably still get the temporary files. This way, you know that all files that have the desired name are correct.

- **SIP or VMS**  :
SIP: Select to make a SIP call.
VMS: Select to make a VMS call.
 - **From SIP account:** Select from the list.
 - **To SIP address:** Enter the SIP address.
 - **Test:** Click to test that your call settings works.
- **Email**
 - **Send email to:** Enter the email address to send emails to. To enter multiple addresses, use commas to separate them.
 - **Send email from:** Enter the email address of the sending server.
 - **Username:** Enter the username for the mail server. Leave this field empty if the mail server does not require authentication.
 - **Password:** Enter the password for the mail server. Leave this field empty if the mail server does not require authentication.
 - **Email server (SMTP):** Enter the name of the SMTP server, for example, smtp.gmail.com, smtp.mail.yahoo.com.
 - **Port:** Enter the port number for the SMTP server, using values in the range 0-65535. The default value is 587.
 - **Encryption:** To use encryption, select either SSL or TLS.
 - **Validate server certificate:** If you use encryption, select to validate the identity of the device. The certificate can be self-signed or issued by a Certificate Authority (CA).
 - **POP authentication:** Turn on to enter the name of the POP server, for example, pop.gmail.com.

Note

Some email providers have security filters that prevent users from receiving or viewing large amount of attachments, from receiving scheduled emails and similar. Check the email provider's security policy to avoid your email account being locked or missing out on your expected emails.

- **TCP**
 - **Host:** Enter the server's IP address or hostname. If you enter a hostname, make sure that a DNS server is specified under **System > Network > IPv4 and IPv6**.
 - **Port:** Enter the port number used to access the server.

Test: Click to test the setup.



The context menu contains:
View recipient: Click to view all the recipient details.
Copy recipient: Click to copy a recipient. When you copy, you can make changes to the new recipient.
Delete recipient: Click to delete the recipient permanently.

Schedules

Schedules and pulses can be used as conditions in rules. The list shows all the schedules and pulses currently configured in the product, along with information about their configuration.  **Add schedule:** Click to create a schedule or pulse.

Manual triggers

You can use the manual trigger to manually trigger a rule. The manual trigger can, for example, be used to validate actions during product installation and configuration.

AXIS C15 Series

The web interface

MQTT

MQTT (Message Queuing Telemetry Transport) is a standard messaging protocol for the Internet of Things (IoT). It was designed for simplified IoT integration and is used in a wide variety of industries to connect remote devices with a small code footprint and minimal network bandwidth. The MQTT client in Axis device software can simplify integration of data and events produced in the device to systems which are not video management software (VMS). Set up the device as an MQTT client. MQTT communication is based on two entities, the clients and the broker. The clients can send and receive messages. The broker is responsible for routing messages between clients. You can learn more about MQTT in *AXIS OS Portal*.

ALPN

ALPN is a TLS/SSL extension that allows for the selection of an application protocol during the handshake phase of the connection between the client and server. This is used to enable MQTT traffic over the same port that is used for other protocols, such as HTTP. In some cases, there might not be a dedicated port open for MQTT communication. A solution in such cases is to use ALPN to negotiate the use of MQTT as the application protocol on a standard port, allowed by the firewalls.

MQTT client

Connect: Turn on or off the MQTT client. **Status:** Shows the current status of the MQTT client. **BrokerHost:** Enter the hostname or IP address of the MQTT server. **Protocol:** Select which protocol to use. **Port:** Enter the port number.

- 1883 is the default value for MQTT over TCP
- 8883 is the default value for MQTT over SSL
- 80 is the default value for MQTT over WebSocket
- 443 is the default value for MQTT over WebSocket Secure

ALPN protocol: Enter the ALPN protocol name provided by your MQTT broker provider. This is only applicable with MQTT over SSL and MQTT over WebSocket Secure. **Username:** Enter the username that the client will use to access the server. **Password:** Enter a password for the username. **Client ID:** Enter a client ID. The client identifier is sent to the server when the client connects to it. **Clean session:** Controls the behavior at connection and disconnection time. When selected, the state information is discarded at connect and disconnect. **HTTP proxy:** A URL with a maximum length of 255 bytes. You can leave the field empty if you don't want to use an HTTP proxy. **HTTPS proxy:** A URL with a maximum length of 255 bytes. You can leave the field empty if you don't want to use an HTTPS proxy. **Keep alive interval:** Enables the client to detect when the server is no longer available without having to wait for the long TCP/IP timeout. **Timeout:** The time interval in seconds to allow a connect to complete. Default value: 60. **Device topic prefix:** Used in the default values for the topic in the connect message and LWT message on the MQTT client tab, and in the publication conditions on the MQTT publication tab. **Reconnect automatically:** Specifies whether the client should reconnect automatically after a disconnect. **Connect message:** Specifies if a message should be sent out when a connection is established. **Send message:** Turn on to send messages. **Use default:** Turn off to enter your own default message. **Topic:** Enter the topic for the default message. **Payload:** Enter the content for the default message. **Retain:** Select to keep the state of client on this Topic. **QoS:** Change the QoS layer for the packet flow. **Last Will and Testament message:** The Last Will Testament (LWT) lets a client provide a testament along with its credentials when connecting to the broker. If the client disconnects ungracefully at some point later (maybe because his power source died), it can let the broker deliver a message to other clients. This LWT message has the same form as an ordinary message and gets routed via the same mechanics. **Send message:** Turn on to send messages. **Use default:** Turn off to enter your own default message. **Topic:** Enter the topic for the default message. **Payload:** Enter the content for the default message. **Retain:** Select to keep the state of client on this Topic. **QoS:** Change the QoS layer for the packet flow.

MQTT publication

Use default topic prefix: Select to use the default topic prefix, that is defined in the device topic prefix in the MQTT client tab. **Include topic name:** Select to include the topic that describes the condition in the MQTT topic. **Include topic namespaces:** Select to include ONVIF topic namespaces in the MQTT topic. **Include serial number:** Select to include the device's serial number in

the MQTT payload.  **Add condition:** Click to add a condition. **Retain:** Defines which MQTT messages are sent as retained.

- **None:** Send all messages as non-retained.
- **Property:** Send only stateful messages as retained.
- **All:** Send both stateful and stateless messages as retained.

QoS: Select the desired level for the MQTT publication.

MQTT subscriptions

AXIS C15 Series

The web interface



Add subscription: Click to add a new MQTT subscription. **Subscription filter:** Enter the MQTT topic that you want to subscribe to. **Use device topic prefix:** Add the subscription filter as prefix to the MQTT topic. **Subscription type:**

- **Stateless:** Select to convert MQTT messages into a stateless message.
- **Stateful:** Select to convert MQTT messages into a condition. The payload is used as the state.

QoS: Select the desired level for the MQTT subscription.

MQTT overlays

Note

Connect to an MQTT broker before you add MQTT overlay modifiers.



Add overlay modifier: Click to add a new overlay modifier. **Topic filter:** Add the MQTT topic that contains the data you want to show in the overlay. **Data field:** Specify the key for the message payload that you want to show in the overlay, assuming the message is in JSON format.

Modifier: Use the resulting modifier when you create the overlay.

- Modifiers that start with **#XMP** show all of the data received from the topic.
- Modifiers that start with **#XMD** show the data specified in the data field.

SIP

Settings

Session Initiation Protocol (SIP) is used for interactive communication sessions between users. The sessions can include audio and video.

SIP setup assistant: Click to set up and configure SIP step by step. **Enable SIP:** Check this option to make it possible to initiate and receive SIP calls. **Allow incoming calls:** Check this option to allow incoming calls from other SIP devices.

Call handling

- **Calling timeout:** Set the maximum duration of an attempted call if no one answers.
- **Incoming call duration:** Set the maximum time an incoming call can last (max 10 min).
- **End calls after:** Set the maximum time that a call can last (max 60 minutes). Select **Infinite call duration** if you don't want to limit the length of a call.

Ports

A port number must be between 1024 and 65535.

- **SIP port:** The network port used for SIP communication. The signaling traffic through this port is non-encrypted. The default port number is 5060. Enter a different port number if required.
- **TLS port:** The network port used for encrypted SIP communication. The signaling traffic through this port is encrypted with Transport Layer Security (TLS). The default port number is 5061. Enter a different port number if required.
- **RTP start port:** The network port used for the first RTP media stream in a SIP call. The default start port number is 4000. Some firewalls block RTP traffic on certain port numbers.

NAT traversal

Use NAT (Network Address Translation) traversal when the device is located on an private network (LAN) and you want to make it available from outside of that network.

Note

For NAT traversal to work, the router must support it. The router must also support UPnP®.

Each NAT traversal protocol can be used separately or in different combinations depending on the network environment.

AXIS C15 Series

The web interface

- **ICE:** The ICE (Interactive Connectivity Establishment) protocol increases the chances of finding the most efficient path to successful communication between peer devices. If you also enable STUN and TURN, you improve the ICE protocol's chances.
- **STUN:** STUN (Session Traversal Utilities for NAT) is a client-server network protocol that lets the device determine if it is located behind a NAT or firewall, and if so obtain the mapped public IP address and port number allocated for connections to remote hosts. Enter the STUN server address, for example, an IP address.
- **TURN:** TURN (Traversal Using Relays around NAT) is a protocol that lets a device behind a NAT router or firewall receive incoming data from other hosts over TCP or UDP. Enter the TURN server address and the login information.

Audio

- **Audio codec priority:** Select at least one audio codec with the desired audio quality for SIP calls. Drag-and-drop to change the priority.

Note

The selected codecs must match the call recipient codec, since the recipient codec is decisive when a call is made.

- **Audio direction:** Select allowed audio directions.

Additional

- **UDP-to-TCP switching:** Select to allow calls to switch transport protocols from UDP (User Datagram Protocol) to TCP (Transmission Control Protocol) temporarily. The reason for switching is to avoid fragmentation, and the switch can take place if a request is within 200 bytes of the maximum transmission unit (MTU) or larger than 1300 bytes.
- **Allow via rewrite:** Select to send the local IP address instead of the router's public IP address.
- **Allow contact rewrite:** Select to send the local IP address instead of the router's public IP address.
- **Register with server every:** Set how often you want the device to register with the SIP server for the existing SIP accounts.
- **DTMF payload type:** Changes the default payload type for DTMF.
- **Max retransmissions:** Set the maximum number of times the device tries to connect to the SIP server before it stops trying.
- **Seconds until failback:** Set the number of seconds until the device tries to reconnect to the primary SIP server after it has failed over to a secondary SIP server.

Accounts

All current SIP accounts are listed under **SIP accounts**. For registered accounts, the colored circle lets you know the status.



The account is successfully registered with the SIP server.



There is a problem with the account. Possible reasons can be authorization failure, that the account credentials are wrong, or that the SIP server can't find the account.

The **peer to peer (default)** account is an automatically created account. You can delete it if you create at least one other account and set that account as default. The default account is always used when a VAPIX® Application Programming Interface (API) call is made without specifying which SIP account to call from.





Add account: Click to create a new SIP account.

- **Active:** Select to be able to use the account.
- **Make default:** Select to make this the default account. There must be a default account, and there can only be one default account.
- **Answer automatically:** Select to automatically answer an incoming call.
- **Prioritize IPv6 over IPv4**  : Select to prioritize IPv6 addresses over IPv4 addresses. This is useful when you connect to peer-to-peer accounts or domain names that resolve in both IPv4 and IPv6 addresses. You can only prioritize IPv6 for domain names that are mapped to IPv6 addresses.
- **Name:** Enter a descriptive name. This can, for example, be a first and last name, a role, or a location. The name is not unique.
- **User ID:** Enter the unique extension or phone number assigned to the device.
- **Peer-to-peer:** Use for direct calls to another SIP device on the local network.
- **Registered:** Use for calls to SIP devices outside the local network, through a SIP server.

AXIS C15 Series

The web interface

- **Domain:** If available, enter the public domain name. It will be shown as part of the SIP address when calling other accounts.
- **Password:** Enter the password associated with the SIP account for authenticating against the SIP server.
- **Authentication ID:** Enter the authentication ID used for authenticating against the SIP server. If it is the same as the user ID, you don't need to enter the authentication ID.
- **Caller ID:** The name which is presented to the recipient of calls from the device.
- **Registrar:** Enter the IP address for the registrar.
- **Transport mode:** Select the SIP transport mode for the account: UDP, TCP, or TLS.
- **TLS version (only with transport mode TLS):** Select the version of TLS to use. Versions v1.2 and v1.3 are the most secure. Automatic selects the most secure version that the system can handle.
- **Media encryption (only with transport mode TLS):** Select the type of encryption for media (audio and video) in SIP calls.
- **Certificate (only with transport mode TLS):** Select a certificate.
- **Verify server certificate (only with transport mode TLS):** Check to verify the server certificate.
- **Secondary SIP server:** Turn on if you want the device to try to register on a secondary SIP server if registration on the primary SIP server fails.
- **SIP secure:** Select to use Secure Session Initiation Protocol (SIPS). SIPS uses the TLS transport mode to encrypt traffic.
- **Proxies**
 -  **Proxy:** Click to add a proxy.
 - **Prioritize:** If you have added two or more proxies, click to prioritize them.
 - **Server address:** Enter the IP address of the SIP proxy server.
 - **Username:** If required, enter the username for the SIP proxy server.
 - **Password:** If required, enter the password for the SIP proxy server.
- **Video** 
 - **View area:** Select the view area to use for video calls. If you select none, the native view is used.
 - **Resolution:** Select the resolution to use for video calls. The resolution affects the required bandwidth.
 - **Frame rate:** Select the number of frames per second for video calls. The frame rate affects the required bandwidth.
 - **H.264 profile:** Select the profile to use for video calls.

DTMF



Add sequence: Click to create a new dual-tone multifrequency (DTMF) sequence. To create a rule that is activated by touch-tone, go to **Events > Rules**. **Sequence:** Enter the characters to activate the rule. Allowed characters: 0-9, A-D, #, and *. **Description:** Enter a description of the action to be triggered by the sequence. **Accounts:** Select the accounts that will use the DTMF sequence. If you choose **peer-to-peer**, all peer-to-peer accounts will share the same DTMF sequence.

Protocols Select the protocols to use for each account. All peer-to-peer accounts share the same protocol settings. **Use RTP (RFC2833):** Turn on to allow dual-tone multifrequency (DTMF) signaling, other tone signals and telephony events in RTP packets. **Use SIP INFO (RFC2976):** Turn to include the INFO method to the SIP protocol. The INFO method adds optional application layer information, generally related to the session.

Test call

SIP account: Select which account to make the test call from. **SIP address:** Enter a SIP address and click  to make a test call and verify that the account works.

Multicast controller

AXIS C15 Series

The web interface

User multicast controller: Turn on to activate multicast controller. Audio codec: Select an audio codec.  Source: Add a new multicast controller source.

- Label: Enter the name of a label that is not already used by a source.
- Source: Enter a source.
- Port: Enter a port.
- Priority: Select a priority.
- Profile: Select a profile.
- SRTP key: Enter an SRTP key.



The context menu contains: Edit: Edit the multicast controller source. Delete: Delete the multicast controller source.

Storage

Network storage

Ignore: Turn on to ignore network storage. Add network storage: Click to add a network share where you can save recordings.

- Address: Enter the IP address or host name of the host server, typically a NAS (network-attached storage). We recommend you to configure the host to use a fixed IP address (not DHCP since a dynamic IP address can change) or that you use DNS. Windows SMB/CIFS names are not supported.
- Network share: Enter the name of the shared location on the host server. Several Axis devices can use the same network share since each device gets its own folder.
- User: If the server requires a login, enter the username. To log in to a specific domain server, type DOMAIN\username.
- Password: If the server requires a login, enter the password.
- SMB version: Select the SMB storage protocol version to connect to the NAS. If you select Auto, the device tries to negotiate one of the secure versions SMB: 3.02, 3.0, or 2.1. Select 1.0 or 2.0 to connect to older NAS that don't support higher versions. You can read more about SMB support in Axis devices *here*.
- Add share without testing: Select to add the network share even if an error is discovered during the connection test. The error can be, for example, that you didn't enter a password even though the server requires one.

Remove network storage: Click to unmount, unbind, and remove the connection to the network share. This removes all settings for the network share. Unbind: Click to unbind and disconnect the network share.

Bind: Click to bind and connect the network share. Unmount: Click to unmount the network share.

Mount: Click to mount the network share. Write protect: Turn on to stop writing to the network share and protect recordings from being removed. You can't format a write-protected network share. Retention time: Select how long to keep recordings, to limit the amount of old recordings, or to comply with regulations regarding data storage. If the network storage becomes full, old recordings are removed before the selected time period passes. Tools

- Test connection: Test the connection to the network share.
- Format: Format the network share, for example, when you need to quickly erase all data. CIFS is the available file system option.

Use tool: Click to activate the selected tool.

Onboard storage

Important

Risk of data loss and corrupted recordings. Do not remove the SD card while the device is running. Unmount the SD card before you remove it.

Unmount: Click to safely remove the SD card. Write protect: Turn on to stop writing to the SD card and protect recordings from being removed. You can't format a write-protected SD card. Autoformat: Turn on to automatically format a newly inserted SD card. It formats the file system into ext4. Ignore: Turn on to stop storing recordings on the SD card. When you ignore the SD card, the device no longer recognizes that the card exists. The setting is only available to administrators. Retention time: Select how long to keep recordings to limit the amount of old recordings or comply with data storage regulations. When the SD card is full, it deletes old recordings before their retention time has passed. Tools

- Check: Check for errors on the SD card.
- Repair: Repair errors in the file system.
- Format: Format the SD card to change the file system and erase all data. You can only format the SD card to the ext4 file system. You need a third-party ext4 driver or application to access the file system from Windows®.

AXIS C15 Series

The web interface

- **Encrypt:** Use this tool to format the SD card and enable encryption. This erases all data stored on the SD card. Any new data you store on the SD card will be encrypted.
- **Decrypt:** Use this tool to format the SD card without encryption. This erases all data stored on the SD card. Any new data you store on the SD card will not be encrypted.
- **Change password:** Change the password required to encrypt the SD card.

Use tool: Click to activate the selected tool.

Wear trigger: Set a value for the SD card wear level at which you want to trigger an action. The wear level ranges from 0–200%. A new SD card that has never been used has a wear level of 0%. A wear level of 100% indicates that the SD card is close to its expected lifetime. When the wear-level reaches 200%, there is a high risk of the SD card malfunctioning. We recommend setting the wear trigger between 80–90%. This gives you time to download any recordings as well as replace the SD card in time before it potentially wears out. The wear trigger allows you to set up an event and get a notification when the wear level reaches your set value.

ONVIF

ONVIF accounts

ONVIF (Open Network Video Interface Forum) is a global interface standard that makes it easier for end-users, integrators, consultants, and manufacturers to take advantage of the possibilities offered by network video technology. ONVIF enables interoperability between different vendor products, increased flexibility, reduced cost and future-proof systems.

When you create an ONVIF account, you automatically enable ONVIF communication. Use the account name and password for all ONVIF communication with the device. For more information see the Axis Developer Community at axis.com.



Add accounts: Click to add a new ONVIF account. **Account:** Enter a unique account name. **New password:** Enter a password for the account. Passwords must be 1 to 64 characters long. Only ASCII printable characters (code 32 to 126) are allowed in the password, for example, letters, numbers, punctuation, and some symbols. **Repeat password:** Enter the same password again. **Role:**

- **Administrator:** Has full access to all settings. Administrators can also add, update, and remove other accounts.
- **Operator:** Has access to all settings except:
 - All **System** settings.
 - Adding apps.
- **Media account:** Allows access to the video stream only.



The context menu contains: **Update account:** Edit the account properties. **Delete account:** Delete the account. You can't delete the root account.

ONVIF media profiles

An ONVIF media profile consists of a set of configurations that you can use to change media stream settings. You can create new profiles with your own set of configurations or use preconfigured profiles for a quick setup.



Add media profile: Click to add a new ONVIF media profile. **Profile name:** Add a name for the media profile. **Video source:** Select the video source for your configuration.

- **Select configuration:** Select a user-defined configuration from the list. The configurations in the drop-down list correspond to the device's video channels, including multiviews, view areas and virtual channels.

Video encoder: Select the video encoding format for your configuration.

- **Select configuration:** Select a user-defined configuration from the list and adjust the encoding settings. The configurations in the drop-down list act as identifiers/names of the video encoder configuration. Select user 0 to 15 to apply your own settings, or select one of the default users if you want to use predefined settings for a specific encoding format.

Note

Enable audio in the device to get the option to select an audio source and audio encoder configuration.



Audio source : Select the audio input source for your configuration.

AXIS C15 Series

The web interface

- **Select configuration:** Select a user-defined configuration from the list and adjust the audio settings. The configurations in the drop-down list correspond to the device's audio inputs. If the device has one audio input, it's user0. If the device has several audio inputs, there will be additional users in the list.

Audio encoder  : Select the audio encoding format for your configuration.

- **Select configuration:** Select a user-defined configuration from the list and adjust the audio encoding settings. The configurations in the drop-down list act as identifiers/names of the audio encoder configuration.

Audio decoder  : Select the audio decoding format for your configuration.

- **Select configuration:** Select a user-defined configuration from the list and adjust the settings. The configurations in the drop-down list act as identifiers/names of the configuration.

Audio output  : Select the audio output format for your configuration.

- **Select configuration:** Select a user-defined configuration from the list and adjust the settings. The configurations in the drop-down list act as identifiers/names of the configuration.

Metadata: Select the metadata to include in your configuration.

- **Select configuration:** Select a user-defined configuration from the list and adjust the metadata settings. The configurations in the drop-down list act as identifiers/names of the metadata configuration.

PTZ  : Select the PTZ settings for your configuration.

- **Select configuration:** Select a user-defined configuration from the list and adjust the PTZ settings. The configurations in the drop-down list correspond to the device's video channels with PTZ support.

Create: Click to save your settings and create the profile. **Cancel:** Click to cancel the configuration and clear all settings. **profile_x:** Click on the profile name to open and edit the preconfigured profile.

Detectors

Audio detection





These settings are available for each audio input. **Sound level:** Adjust the sound level to a value from 0–100, where 0 is the most sensitive and 100 the least sensitive. Use the activity indicator as a guide when you set the sound level. When you create events, you can use the sound level as a condition. You can choose to trigger an action if the sound level rises above, falls below or passes the set value.

Accessories

I/O ports

Use digital input to connect external devices that can toggle between an open and closed circuit, for example, PIR sensors, door or window contacts, and glass break detectors.

Use digital output to connect external devices such as relays and LEDs. You can activate connected devices through the VAPIX® Application Programming Interface or the web interface.

PortName: Edit the text to rename the port. **Direction:**  indicates that the port is an input port.  indicates that it's an output port. If the port is configurable, you can click the icons to change between input and output. **Normal state:** Click  for open circuit, and  for closed circuit. **Current state:** Shows the current state of the port. The input or output is activated when the current state is different from the normal state. An input on the device has an open circuit when it's disconnected or when there is a voltage above 1 VDC.

Note

During restart, the output circuit is open. When the restart is complete, the circuit goes back to the normal position. If you change any settings on this page, the output circuits go back to their normal positions regardless of any active triggers.

AXIS C15 Series

The web interface

 **Supervised** : Turn on to make it possible to detect and trigger actions if someone tampers with the connection to digital I/O devices. In addition to detecting if an input is open or closed, you can also detect if someone has tampered with it (that is, cut or shorted). To supervise the connection requires additional hardware (end-of-line resistors) in the external I/O loop.

Logs

Reports and logs

Reports

- **View the device server report:** View information about the product status in a pop-up window. The Access Log is automatically included in the Server Report.
- **Download the device server report:** It creates a .zip file that contains a complete server report text file in UTF-8 format, as well as a snapshot of the current live view image. Always include the server report .zip file when you contact support.
- **Download the crash report:** Download an archive with detailed information about the server's status. The crash report contains information that is in the server report as well as detailed debug information. This report might contain sensitive information such as network traces. It can take several minutes to generate the report.

Logs

- **View the system log:** Click to show information about system events such as device startup, warnings, and critical messages.
- **View the access log:** Click to show all failed attempts to access the device, for example, when a wrong login password is used.

Remote system log

Syslog is a standard for message logging. It allows separation of the software that generates messages, the system that stores them, and the software that reports and analyzes them. Each message is labeled with a facility code, which indicates the software type generating the message, and assigned a severity level.



Server: Click to add a new server.**Host:** Enter the hostname or IP address of the server.**Format:** Select which syslog message format to use.

- Axis
- RFC 3164
- RFC 5424

Protocol: Select the protocol to use:

- UDP (Default port is 514)
- TCP (Default port is 601)
- TLS (Default port is 6514)

Port: Edit the port number to use a different port.**Severity:** Select which messages to send when triggered.**CA certificate set:** See the current settings or add a certificate.

Plain config

Plain config is for advanced users with experience of Axis device configuration. Most parameters can be set and edited from this page.

AXIS C15 Series

The web interface

Maintenance

Maintenance

Restart: Restart the device. This does not affect any of the current settings. Running applications restart automatically.**Restore:** Return *most* settings to the factory default values. Afterwards you must reconfigure the device and apps, reinstall any apps that didn't come preinstalled, and recreate any events and presets.

Important

The only settings saved after restore are:

- Boot protocol (DHCP or static)
- Static IP address
- Default router
- Subnet mask
- 802.1X settings
- O3C settings
- DNS server IP address

Factory default: Return *all* settings to the factory default values. Afterwards you must reset the IP address to make the device accessible.

Note

All Axis device software is digitally signed to ensure that you only install verified software on your device. This further increases the overall minimum cybersecurity level of Axis devices. For more information, see the white paper "Axis Edge Vault" at axis.com.

AXIS OS upgrade: Upgrade to a new AXIS OS version. New releases can contain improved functionality, bug fixes, and completely new features. We recommend you to always use the latest AXIS OS release. To download the latest release, go to axis.com/support. When you upgrade, you can choose between three options:

- **Standard upgrade:** Upgrade to the new AXIS OS version.
- **Factory default:** Upgrade and return all settings to the factory default values. When you choose this option, you can't revert to the previous AXIS OS version after the upgrade.
- **Autorollback:** Upgrade and confirm the upgrade within the set time. If you don't confirm, the device reverts to the previous AXIS OS version.

AXIS OS rollback: Revert to the previously installed AXIS OS version.

Troubleshoot

Ping: To check if the device can reach a specific address, enter the hostname or IP address of the host you want to ping and click **Start**.**Port check:** To verify connectivity from the device to a specific IP address and TCP/UDP port, enter the hostname or IP address and port number you want to check and click **Start**.**Network trace**

Important

A network trace file might contain sensitive information such as certificates or passwords.

A network trace file can help you troubleshoot problems by recording activity on the network. **Trace time:** Select the duration of the trace in seconds or minutes and click **Download**.

AXIS C15 Series

Troubleshooting

Troubleshooting

Reset to factory default settings

Important

Reset to factory default should be used with caution. A reset to factory default resets all settings, including the IP address, to the factory default values.

To reset the product to the factory default settings:

1. Disconnect power from the product.
2. Press and hold the control button while reconnecting power. See *Product overview on page 40*.
3. Keep the control button pressed for 10 seconds until the status LED indicator turns amber for the second time.
4. Release the control button. The process is complete when the status LED indicator turns green. If no DHCP server is available on the network, the device IP address will default to one of the following:
 - Devices with AXIS OS 12.0 and later: Obtained from the link-local address subnet (169.254.0.0/16)
 - Devices with AXIS OS 11.11 and earlier: 192.168.0.90/24
5. Use the installation and management software tools, assign an IP address, set the password, and access the product.

You can also reset parameters to factory default through the device's web interface. Go to **Maintenance > Factory default** and click **Default**.

Check the current AXIS OS version

AXIS OS determines the functionality of our devices. When you troubleshoot a problem, we recommend that you to start by checking the current AXIS OS version. The latest version might contain a correction that fixes your particular problem.

To check the current AXIS OS version:

1. Go to the device's web interface > **Status**.
2. Under **Device info**, see the AXIS OS version.

Upgrade AXIS OS

Important

- Preconfigured and customized settings are saved when you upgrade the device software (provided that the features are available in the new AXIS OS) although this is not guaranteed by Axis Communications AB.
- Make sure the device remains connected to the power source throughout the upgrade process.

Note

When you upgrade the device with the latest AXIS OS version in the active track, the product receives the latest functionality available. Always read the upgrade instructions and release notes available with each new release before you upgrade. To find the latest AXIS OS version and the release notes, go to axis.com/support/device-software.

1. Download the AXIS OS file to your computer, available free of charge at axis.com/support/device-software.
2. Log in to the device as an administrator.
3. Go to **Maintenance > AXIS OS upgrade** and click **Upgrade**.

When the upgrade has finished, the product restarts automatically.

AXIS C15 Series

Troubleshooting

Technical issues, clues and solutions

If you can't find what you're looking for here, try the troubleshooting section at axis.com/support.

Problems upgrading the firmware

Firmware upgrade failure	If the firmware upgrade fails, the device reloads the previous firmware. The most common reason is that the wrong firmware file has been uploaded. Check that the name of the firmware file corresponds to your device and try again.
--------------------------	---

Problems setting the IP address

The device is located on a different subnet	If the IP address intended for the device and the IP address of the computer used to access the device are located on different subnets, you cannot set the IP address. Contact your network administrator to obtain an IP address.
The IP address is being used by another device	Disconnect the Axis device from the network. Run the ping command (in a Command/DOS window, type <code>ping</code> and the IP address of the device): <ul style="list-style-type: none">• If you receive: <code>Reply from <IP address>: bytes=32; time=10...</code> this means that the IP address may already be in use by another device on the network. Obtain a new IP address from the network administrator and reinstall the device.• If you receive: <code>Request timed out</code>, this means that the IP address is available for use with the Axis device. Check all cabling and reinstall the device.
Possible IP address conflict with another device on the same subnet	The static IP address in the Axis device is used before the DHCP server sets a dynamic address. This means that if the same default static IP address is also used by another device, there may be problems accessing the device.

The device cannot be accessed from a browser

Cannot log in	When HTTPS is enabled, ensure that the correct protocol (HTTP or HTTPS) is used when attempting to log in. You may need to manually type <code>http</code> or <code>https</code> in the browser's address field. If the password for the user <code>root</code> is lost, the device must be reset to the factory default settings. See <i>Reset to factory default settings on page 37</i> .
The IP address has been changed by DHCP	IP addresses obtained from a DHCP server are dynamic and may change. If the IP address has been changed, use AXIS IP Utility or AXIS Device Manager to locate the device on the network. Identify the device using its model or serial number, or by the DNS name (if the name has been configured).
Certificate error when using IEEE 802.1X	For authentication to work properly, the date and time settings in the Axis device must be synchronized with an NTP server. Go to Settings > System > Date and time .

The device is accessible locally but not externally

To access the device externally, we recommend using one of the following applications for Windows®:

- AXIS Camera Station: 30-day trial version free of charge, ideal for small to mid-size systems.

For instructions and download, go to axis.com/vms.

Problems with sound files

Can't upload media clip	The following audio clip formats are supported: <ul style="list-style-type: none">• au file format, encoded in μ-law and sampled with 8 or 16 kHz.• wav file format, encoded in PCM audio. It supports encoding as 8 or 16-bit mono or stereo and sample rate of 8 to 48 kHz.• mp3 file format, in mono or stereo with bitrate of 64 kbps to 320 kbps and sample rate of 8 to 48 kHz.
-------------------------	--

AXIS C15 Series

Troubleshooting

Media clips are played with different volumes A sound file is recorded with a certain gain. If your audio clips have been created with different gains, they will be played with a different loudness. Make sure that you use clips that have the same gain.

Performance considerations

When setting up your system, it is important to consider how various settings and situations affect the amount of needed bandwidth (the bitrate) required.

The following factors are the most important to consider:

- Heavy network utilization due to poor infrastructure affects the bandwidth.
- Running multiple AXIS Camera Application Platform (ACAP) applications simultaneously may affect the general performance.

AXIS C15 Series

Specifications

Specifications

Product overview

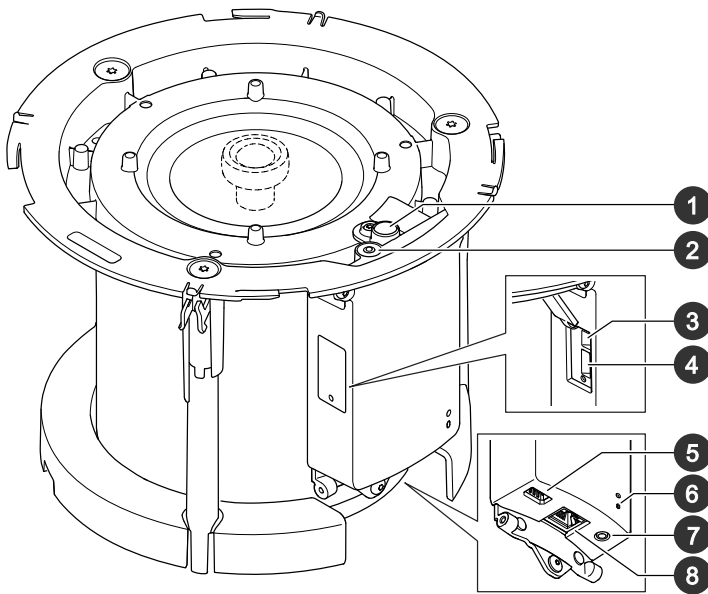

- 1 *Front-facing LED*
- 2 *Control button on page 41*
- 3 *Microphone disable switch on page 41*
- 4 *SD card slot on page 41*
- 5 *I/O connector on page 42*
- 6 *Status LED*
- 7 *Audio connector on page 41*
- 8 *Network connector on page 41*

LED indicators

Status LED	Indication
Unlit	Unlit for normal operation.
Green	Steady for 10 seconds for normal operation after startup completed.
Amber	Steady during startup. Flashes during device software upgrade or reset to factory default.
Amber/Red	Flashes if network connection is unavailable or lost.
Red	Flashes slowly if upgrade failed.
Red/Green	Flashes fast when Locate device is selected.

AXIS C15 Series

Specifications

SD card slot

NOTICE

- Risk of damage to SD card. Don't use sharp tools, metal objects, or excessive force when inserting or removing the SD card. Use your fingers to insert and remove the card.
- Risk of data loss and corrupted recordings. Unmount the SD card from the device's web interface before removing it. Don't remove the SD card while the product is running.

For SD card recommendations, see axis.com.



SD, SDHC, and SDXC Logos are trademarks of SD-3C LLC. SD, SDHC and SDXC are trademarks or registered trademarks of SD-3C, LLC in the United States, other countries or both.

Buttons

Control button

The control button is used for:

- Calibrating the speaker test. Press and release the control button and a test tone is played.
- Resetting the product to factory default settings. See *Reset to factory default settings on page 37*.

Microphone disable switch

For location of the microphone disable switch, see *Product overview on page 40*.

The microphone disable switch is used to mechanically turn the microphone **ON** or **OFF**. The factory default setting for this switch is **ON**.

Connectors

Network connector

RJ45 Ethernet connector with Power over Ethernet (PoE).

NOTICE

The product shall be connected using a shielded network cable (STP). All cables connecting the product to the network shall be intended for their specific use. Make sure that the network devices are installed in accordance with the manufacturer's instructions. For information about regulatory requirements, see the Installation Guide at www.axis.com.

Audio connector

- Audio in – 3.5 mm input for a stereo microphone, or a line-in stereo signal.

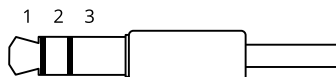

Audio input

1 Tip	2 Ring	3 Sleeve
Unbalanced microphone (with or without electret power) or line	Electret power if selected	Ground

AXIS C15 Series

Specifications

Balanced microphone (with or without phantom power) or line, "hot" signal	Balanced microphone (with or without phantom power) or line, "cold" signal	Ground
Digital signal	Ring power if selected	Ground
Stereo unbalanced microphone (with or without electret power) or line, "left"	Stereo unbalanced microphone (with or without electret power) or line, "right"	Ground

Audio output

1 Tip	2 Ring	3 Sleeve
Channel 1, unbalanced line, mono	Channel 1, unbalanced line, mono	Ground
Balanced line, "hot" signal	Balanced line, "cold" signal	Ground
Stereo unbalanced line, "left"	Stereo unbalanced line, "right"	Ground
Channel 1, unbalanced line	Channel 2, unbalanced line	Ground

The internal microphone is used by default; the external microphone is used when connected.

I/O connector

Use the I/O connector with external devices in combination with, for example, motion detection, event triggering, and alarm notifications. In addition to the 0 VDC reference point and power (12 V DC output), the I/O connector provides the interface to:

Digital input – For connecting devices that can toggle between an open and closed circuit, for example PIR sensors, door/window contacts, and glass break detectors.

Supervised input – Enables possibility to detect tampering on a digital input.

Digital output – For connecting external devices such as relays and LEDs. Connected devices can be activated by the VAPIX® Application Programming Interface, through an event or from the device's web interface.

4-pin terminal block

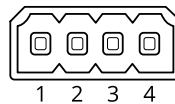

Function	Pin	Notes	Specifications
DC ground	1		0 VDC
DC output	2	Can be used to power auxiliary equipment. Note: This pin can only be used as power out.	12 VDC Max load = 50 mA
Configurable (Input or Output)	3-4	Digital input or Supervised input – Connect to pin 1 to activate, or leave floating (unconnected) to deactivate. To use supervised input, install end-of-line resistors. See connection diagram for information about how to connect the resistors.	0 to max 30 VDC
		Digital output – Internally connected to pin 1 (DC ground) when active, and floating (unconnected) when inactive. If used with an inductive load, e.g., a relay, connect a diode in parallel with the load, to protect against voltage transients.	0 to max 30 VDC, open drain, 100 mA

Example:

AXIS C15 Series

Specifications

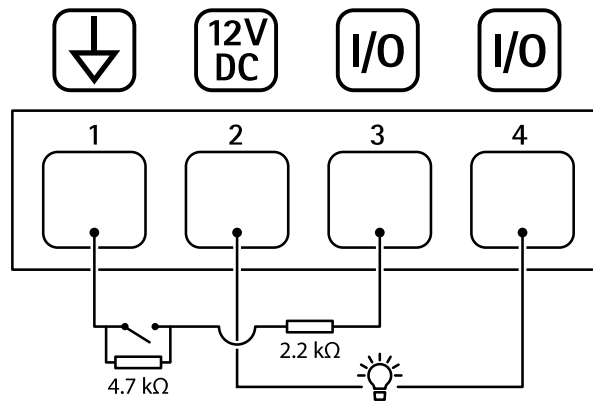

- 1 DC ground
- 2 DC output 12 V, max 50 mA
- 3 I/O configured as supervised input
- 4 I/O configured as output

AXIS C15 Series

API commands

API commands

VAPIX® is Axis' own open API (Application Programming Interface). You can control almost all functionality available in Axis devices through VAPIX®. To get access to the complete VAPIX® documentation, join Axis Developer Community at axis.com/developer-community

Enter the commands in a web browser, and replace <deviceIP> with the IP address or host name of your device.

Important

The API commands execute immediately. If you restore or reset your device all settings will be lost. For example action rules.

Example:

Restart the device

Request

```
http://<deviceIP>/axis-cgi/restart.cgi
```

Example:

Restore the device. The request returns most settings to default values, but keeps the IP number.

Request

```
http://<deviceIP>/axis-cgi/factorydefault.cgi
```

Example:

Reset the device. The request returns all settings including IP number to default values.

Request

```
http://<deviceIP>/axis-cgi/hardfactorydefault.cgi
```

Example:

See a list of all device parameters.

Request

```
http://<deviceIP>/axis-cgi/param.cgi?action=list
```

Example:

Get a debug archive

Request

```
http://<deviceIP>/axis-cgi/debug/debug.tgz
```

Example:

Get a server report

Request

```
http://<deviceIP>/axis-cgi/serverreport.cgi
```

Example:

Capture a network trace of 300 seconds

Request

```
http://<deviceIP>/axis-cgi/debug/debug.tgz?cmd=pcapdump&duration=300
```

Example:

Enable FTP

Request

```
http://<deviceIP>/axis-cgi/param.cgi?action=update&Network.FTP.Enabled=yes
```

Example:

AXIS C15 Series

API commands

Disable FTP

Request

`http://<deviceIP>/axis-cgi/param.cgi?action=update&Network.FTP.Enabled=no`

Example:

Enable SSH

Request

`http://<deviceIP>/axis-cgi/param.cgi?action=update&Network.SSH.Enabled=yes`

Example:

Disable SSH

Request

`http://<deviceIP>/axis-cgi/param.cgi?action=update&Network.SSH.Enabled=no`

