

## AXIS Companion Eye L

## User Manual

# AXIS Companion Eye L

## About AXIS Companion Eye L

---

### About AXIS Companion Eye L

AXIS Companion Eye L is a mini dome with a flat-faced design that suppresses reflections. Using WDR technology and IR illumination, it provides compact HDTV surveillance even in challenging light conditions or total darkness. The design allows for repainting, or using the black accessory casing to blend the camera into its environment. Axis' Zipstream technology reduces bandwidth and storage requirements.

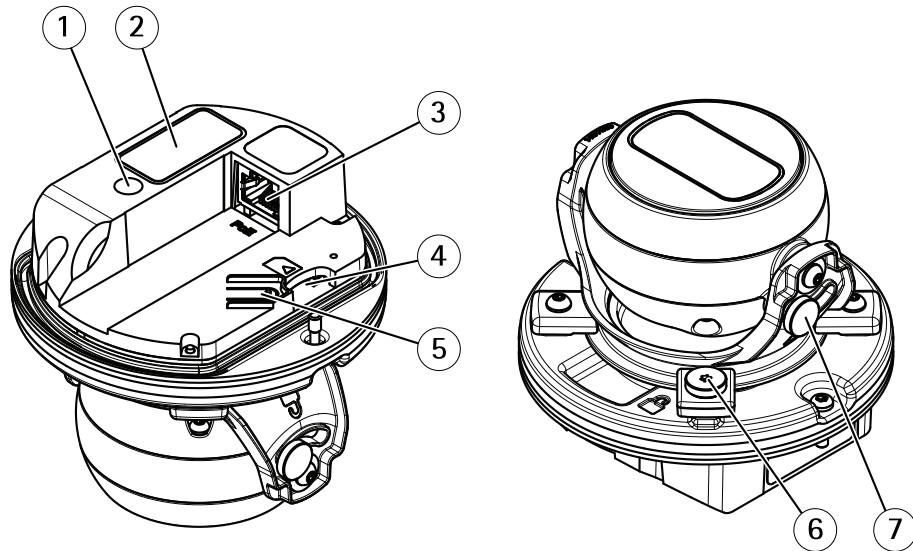

- 1 Status LED indicator
- 2 Part number (P/N) & Serial number (S/N)
- 3 Network connector (PoE)
- 4 SD card slot
- 5 Control button
- 6 Pan lock screw
- 7 Tilt lock screw

# AXIS Companion Eye L

## The AXIS Companion solution

---

### The AXIS Companion solution

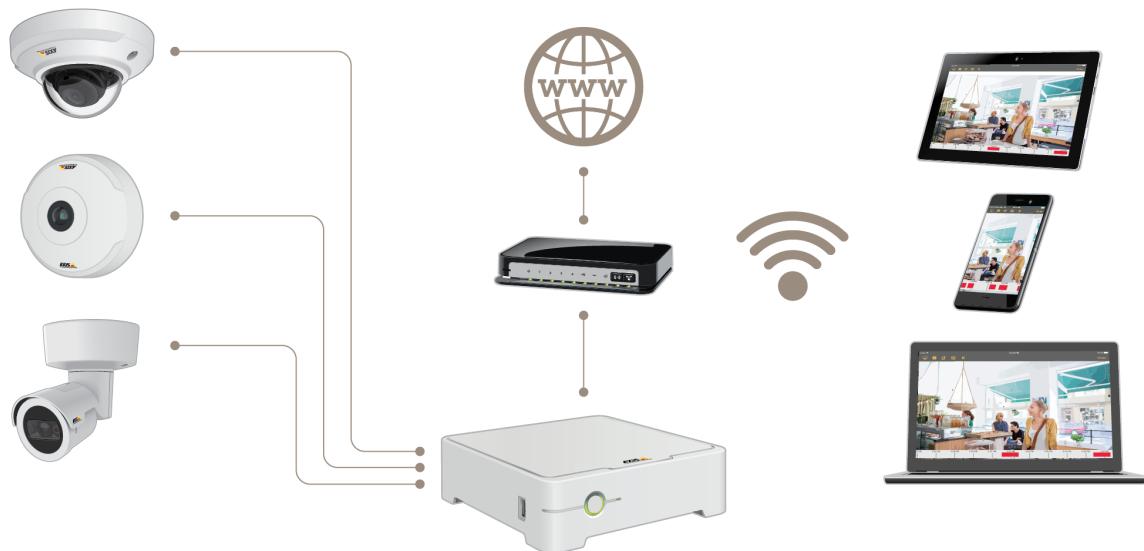

AXIS Companion is a complete end-to-end surveillance solution designed to meet the requirements of small systems with basic surveillance requirements.

An AXIS Companion solution can consist of:

- AXIS Companion cameras, Axis IP cameras and encoders with firmware 8.40 or higher.
- AXIS Companion recorders.
- Axis system accessories, such as memory cards and switches.
- AXIS Companion software for Windows computers as well as mobile devices and TV streaming devices (iOS and Android).

### Learn more about AXIS Companion

For video tutorials and web apps, visit [axis.com/products/axis-companion/how-it-works](http://axis.com/products/axis-companion/how-it-works)

# AXIS Companion Eye L

## Get started with AXIS Companion

---

### Get started with AXIS Companion

#### Note

Internet access is required during the system setup.

#### Installation overview:

1. *Register a MyAxis account on page 4*
2. *Install the hardware on page 5*
3. *Install the desktop app on page 5*
4. *Create a site on page 6*
5. *Install the mobile app on page 7*

#### Result of system installation:

- The firmware is upgraded on all Axis devices.
- A password is set for the devices.
- The recordings are enabled with default settings.
- The remote access is enabled.

## Register a MyAxis account

Register a MyAxis account at [axis.com/my-axis/login](http://axis.com/my-axis/login).

You can make your MyAxis account more secure by activating multi-factor authentication (MFA). MFA is a security system that adds another layer of verification to ensure the user's identity.

#### Activate MFA:

1. Go to <http://auth.axis.com/user-center/account/security-settings>.
2. Turn on **2-Step verification**.

You are redirected to a login page.

3. Log in with your **MyAxis** credentials.

MFA is now active.

#### Log in when MFA is active:

1. Log in to your **MyAxis** account.

An email is sent to you.

2. Open the email and click **Authenticate**.

If you didn't receive an email, then check if it's in your spam folder. If it's not there, then contact IT support.

# AXIS Companion Eye L

## Get started with AXIS Companion

---

### Install the hardware



To watch this video, go to the web version of this document.

[www.axis.com/products/online-manual/22571#t10169306](http://www.axis.com/products/online-manual/22571#t10169306)

*Installation video for the product.*

1. Install your camera hardware.
2. Connect the recorder to your network via the LAN port.

#### Note

If you have no recorder, then you need a camera with an SD card if you want to be able to record video.

3. Connect the cameras to the recorder's integrated PoE switch or an external PoE switch.
4. Connect the computer to the same network as the recorder.
5. Connect the power supply to the recorder.

#### Important

You must first connect the power cord to the recorder, and then connect the power cord to the power outlet.

6. Wait a few minutes for the recorder and cameras to boot up before proceeding.

#### ⚠CAUTION

Keep the recorder in a well ventilated environment and with plenty of empty space around the recorder to avoid overheating.

### Install the desktop app

1. Go to [axis.com/products/axis-companion](http://axis.com/products/axis-companion) and click **Download** to download the AXIS Companion desktop app for Windows.
2. Sign in using your *MyAxis* account.
3. Read the license agreement, and select one of the alternatives to proceed.
4. Save the file to a location of your choice.
5. Open the file, and click **Run** to start the installation.
6. If you want to allow the app to make changes on your device, click **Yes**.
7. Select language and click **OK**.
8. Follow the setup wizard.

# AXIS Companion Eye L

## Get started with AXIS Companion

---

### Create a site



To watch this video, go to the web version of this document.

[www.axis.com/products/online-manual/22571#t10112114](http://www.axis.com/products/online-manual/22571#t10112114)

A site is a single point of entry to a surveillance solution, for example all cameras in a store. You can keep track of several sites through a single MyAxis account.

#### Note

If you have used an earlier version of AXIS Companion, then you might have devices that are not supported in AXIS Companion version 4. Unsupported devices include third-party NAS devices and old Axis devices with a firmware that can't be updated to 5.50 or later. The wizard will inform you about any such issues and help you to address them.

#### Note

Sites that were created in an earlier version than AXIS Companion version 4, will not appear in the list of sites. You can read the Migration Guide (available on the support web page) for more information.

1. Start the AXIS Companion desktop app.
2. Sign in with your *MyAxis account*.
3. Click **Get started**.
4. Name your site and enter your company name.
5. Click **Next**.
6. Select the devices you want to add to your site.

If any devices are password-protected, then you must enter the password for them before they can be selected.

#### Note

If you have devices that are not supported, then you can click **Read more** to find out why they are not supported.

7. Click **Next**.
8. Enter a password.  
This password is used for accessing the device webpages or offline mode in the AXIS Companion mobile app.
9. Click **Next**.
10. On the **Ready to install** page, there might be a list of cameras that need to be restored. If so, click the **Restore device** link to fix the issue on the device webpage.
11. Click **Finish** and wait while AXIS Companion configures the cameras.

#### Note

The configuration may take several minutes.

# AXIS Companion Eye L

## Get started with AXIS Companion

---

For getting-started video tutorials, see *AXIS Companion tutorials*.

### **Install the mobile app**

You can use the AXIS Companion mobile app to set up your system and control it from anywhere. Real-time alert notifications keep you aware of any suspicious activity. You can also view and export video recordings.

1. Go to your App store or Google play.
2. Search for **AXIS Companion 4** and download the app.
3. Sign in to AXIS Companion with your *MyAxis account*.

To find out more on how to use the app, see *AXIS Companion tutorials*.

# AXIS Companion Eye L

## Daily use

---

### Daily use

#### How do I use the product in low light conditions?

In low light or complete darkness, the product can use infrared (IR) light to deliver black and white images. The IR illumination turns on when the product switches from day mode to night mode. Image noise may occur in low light if the IR illumination is turned off or has not yet been activated.

#### How to change at which light condition the night mode turns on

1. Go to  and log in to the product's webpage.
2. Go to **Settings > Image > Day and Night**.
3. Make sure the **IR-cut filter** is set to **Auto**.
4. Make sure that **IR illumination** is switched on.
5. Use the **Night threshold** to change in what light condition the night mode turns on.

#### Access your cameras

1. Sign in to AXIS Companion on a computer or a mobile device using your *MyAxis account*.
2. Enter the site that contains your cameras.

Find out more at *AXIS Companion tutorials*.

#### View live video



To watch this video, go to the web version of this document.

[www.axis.com/products/online-manual/22571#t10074647](http://www.axis.com/products/online-manual/22571#t10074647)

1. Go to 
2. Select which camera you want to view.

To watch a video of how to zoom, pan and take snapshots, see the *AXIS Companion tutorials*.



# AXIS Companion Eye L

## Daily use

---

### Play a recording



To watch this video, go to the web version of this document.

[www.axis.com/products/online-manual/22571#t10074285](http://www.axis.com/products/online-manual/22571#t10074285)

1. Go to 
2. Use the timeline and calendar to find the recording.
3. Select the camera in the timeline and move the playback marker to the desired time.



#### Note

When you move the playback marker, the video image is updated continuously. This makes it easy for you to find a specific moment in the recording.

4. Click **Play**.

To watch a video of how to browse and play recordings, see the *AXIS Companion tutorials*.

### Save a recording

1. Go to  > 
2. Select start and end times for a camera recording.
3. Select which cameras to save recordings from.
4. To save to a USB drive on an AXIS S3008 Recorder, select the **Save to recorder USB** checkbox.
5. Save the recording.

To watch a video of how to save recordings, see the *AXIS Companion tutorials*.

### Play a saved recording

To play a saved recording, open it with AXIS File Player.

When you save a recording, the AXIS File Player will be saved in the same folder. The AXIS File Player has a timeline showing what time the recording was made.

### Validate a saved recording

You can validate a recording to confirm that the timestamp and images have not been manipulated after the recording was first saved. For this purpose, a digital signature will be included in the file when you save a recording. You can add a password to the digital signature for increased security.

# AXIS Companion Eye L

## Daily use

---

Protect your digital signature with a password:

1. In AXIS Companion, go to  > **Customize**.
2. Under **Recordings**, select **Show digital signature options when saving recordings**.

When saving a recording now, the **Digital signature** window will appear, allowing you to choose a password for the signature.

Validate a recording:

1. Open the saved recording with AXIS File Player.
2. Click **Tools** and select **Verify digital signature**.
3. Enter password, if a password was applied to the signature, and click **OK**.



A window appears to inform whether or not the recording is valid.

## Take a snapshot

Take a snapshot from live view:

- Click 

Take a snapshot from recordings:

1. Use the timeline and calendar to find the recording.
2. Select the camera in the timeline and move the playback marker to the desired time.
3. Click  to start investigation mode.
  - Investigation mode allows you to step through the recorded video, frame by frame, to find the exact moment when an incident happened and take a snapshot from that moment.
4. To find the incident, click on the thumbnails to step 30, 15, 5 or 1 frames backward (top panel) or forward (bottom panel). You can also move the slider.
5. When satisfied, click  to take a snapshot.
  - For most cameras the snapshot will contain the entire camera image, regardless of the zoom level. For cameras with a dewarped image, the snapshot will be the zoomed-in image.

Change the folder where snapshots are saved:

1. Go to  > **Customize**.
2. Change the settings under **Snapshots**.

## Adjust the image settings

1. Go to  > **Cameras**.

# AXIS Companion Eye L

## Daily use

---

2. Click  > **Image settings** for the camera you want to adjust.

You can control the image by adjusting settings like:

- Appearance
- Exposure
- Overlay
- Day & Night
- Privacy mask
- Focus & zoom

### Configure the video quality

You can configure the video quality to suit your image quality requirements and bandwidth usage. Video quality settings affect motion recording, continuous recording and live view.

1. Go to  > **Cameras**.
2. Right-click the camera you want to configure and select **Video Quality Settings**.
3. Edit the profile settings for:
  - **High** (resolutions with an image width above 640 pixels)
  - **Low** (resolutions with an image width up to 640 pixels)
  - **Axis Mobile Streaming**
4. Select **Axis Mobile Streaming** to improve playback performance for thumbnails and mobile apps.
  - **Axis Mobile Streaming** is activated when there is only one **High** profile active and the resolution is set for HD (1280x720) or above. Selecting **Axis Mobile Streaming** slightly increases storage usage.
  - When playing recordings, only those recorded with **Axis Mobile Streaming** enabled can toggle between **High** and **Low**.
5. Click **OK** to save.

### Configure video motion detection

Recording only when motion is detected saves considerably on disk space and bandwidth, compared to continuous recording.

If the motion detection is triggered too often, you can adjust the settings to ignore parts of the view or certain types of events.

# AXIS Companion Eye L



## Daily use

---



To watch this video, go to the web version of this document.

[www.axis.com/products/online-manual/22571#t10130736](http://www.axis.com/products/online-manual/22571#t10130736)

1. In AXIS Companion, go to  > Cameras.
2. Make sure the camera is enabled in the **Motion detection** column.
3. Click  for a camera and select **Motion recording....**
4. In the **Motion recording** dialog, click **Settings....**
5. Choose what part of the camera view to include in the motion detection:
  - Edit the dark area to be included for motion detection.
  - To draw an area that will be excluded from motion detection, select **Exclude area** and edit the light area.

### Note

For some camera models you can only draw squares, and for others you can draw more complex polygons.

6. Expand **Advanced** to adjust the settings of the filters.
  - **Small objects filter** – Ignore objects that are small, such as animals.
  - **Swaying objects filter** – Ignore objects that only move within a short distance, such as trees or flags that move when it is windy.

### Note

The swaying objects filter is not available for all camera models.

- **Short-lived objects filter** – Ignore objects that only appear for a short period of time, such as light beams from passing cars or fast-moving shadows.
7. Click OK twice.

## Set up notifications

You can make AXIS Companion send a notification to your mobile app when certain types of motion occur in a camera view.

The motion triggers are based on the following ACAPs:

- AXIS Video Motion Detection
- AXIS Fence Guard

Workflow:

1. Make sure the ACAP is activated in your device.

# AXIS Companion Eye L

## Daily use

---

2. In AXIS Companion, go to  > Events and select an ACAP.
3. Configure a schedule for when you want to receive notifications.
4. Under **Activation**, select the cameras you want notifications from.

### Receiving notifications on your mobile device:

- Push notifications are sent to your mobile app if you are logged in to your MyAxis account on your mobile.
- When you install the AXIS Companion 4 mobile app, you must accept when prompted with a question if you want to receive notifications. If you want to deactivate the notifications later on, go to the settings of your mobile device, select the AXIS Companion 4 app, and disable the notifications.

To turn notifications on or off in the mobile app:

1. Go to  > Notifications.
2. Turn **Motion detection** on or off.

When a notification is sent, it will appear as a popup message on your mobile device. Tap the message to open the playback of the ongoing event.

## Add a user



To watch this video, go to the web version of this document.

[www.axis.com/products/online-manual/22571#t10133929](http://www.axis.com/products/online-manual/22571#t10133929)



1. Go to  > Users.
2. Click **Add...**
3. Enter an email address and select an access level, then click **OK**.

The following access levels are available:

# AXIS Companion Eye L

## Daily use

---

Administrator	 Full access
Operator	 Can access recordings and live view, but can't make any changes to the site
Viewer	 Can only access live view

### Activate offline mode

If you are running AXIS Companion while there is no connection to the internet, then you can enter offline mode. This makes Live view and Recordings available locally. However, you will not be able to access the Configuration menu while the internet connection is down.

Activate offline mode:

- Click  > Site and turn on Offline mode.

#### Note

You can only use live view and playback while in offline mode. All other operations require connection to the internet.

The PC that access the site in offline mode should be connected to the same subnet as the cameras. You can't use offline mode if any of the networks the PC is connected to have access to the internet.

To be able to access the site without internet connection, you need to activate offline mode in advance while the site is online.

For sites that will be used mostly offline, we recommend you to set them up with static IP or DHCP reservation.

Notifications will not be sent during offline mode.

### Show video on an external display



To watch this video, go to the web version of this document.

[www.axis.com/products/online-manual/22571#t10134228](http://www.axis.com/products/online-manual/22571#t10134228)

What you need:

- An Apple TV or Android TV device.
- The AXIS Companion 4 app installed on your mobile device.
- The AXIS Companion TV app installed from the app store on your Apple TV or Android TV device.

# AXIS Companion Eye L

## Daily use

---

- Your cameras, mobile app and TV app must all be connected to the same local network.
- AppleTV 4 and Nvidia Shield with Android 6 or later.

This is how you do it:

1. Open the AXIS Companion 4 mobile app and log in.
2. Go to **Devices** >  and select your external display.

### Note



It may take a few seconds before the icon appears.

3. Select the cameras you want to show on your external display.
4. Tap  and wait for the configuration to complete.
5. You can view a single camera at a time or create a split view with up to 16 cameras.
6. When the AXIS Companion 4 TV app opens, read the instructions on the screen about how to navigate in the app.

## Monitor a narrow space

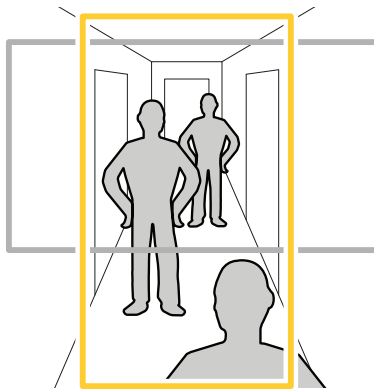
Use corridor format to better utilize the full field of view in a long and narrow space, for example a staircase, hallway, road, or tunnel.



1. Adjust the camera or its lens to a vertical field of view.
2. In AXIS Companion, go to  > **Cameras**.
3. On the row of the camera you want to adjust, click  > **Image settings**.
4. On the **Appearance** tab, select a suitable angle for **Orientation**.
5. Click **Close**.

## Connect to a door station

You can connect a door station to both your AXIS Companion desktop app as well as the mobile app. This makes it possible for you to answer calls, unlock a door and view a door station video with your mobile device.

# AXIS Companion Eye L

## Daily use

---

### Note

To unlock a door, your door station must be properly connected to the door's electronic lock. The documentation for your door station contains information about how to make this connection correctly. To find the documentation for your door station, go to [axis.com/products/access-control/network-door-stations](https://axis.com/products/access-control/network-door-stations)

### Note

Make sure the door station is connected to the same network as your computer, otherwise it won't show up in the list of devices in your AXIS Companion apps.

### Connect your desktop app to a door station

1. In the AXIS Companion desktop app, go to  > **Cameras**.
2. Click **Add devices** and add the door station.

You can now answer the door station with your AXIS Companion desktop app.

### Connect your mobile app to a door station

1. *Connect your desktop app to a door station on page 16.*
2. Start the AXIS Companion 4 mobile app.
3. Log in to the same MyAxis account as you used for the desktop app.

You can now answer the door station with your AXIS Companion 4 mobile app.

Give other users access to the door station:

1. From the AXIS Companion desktop app, go to  > **Users**.
2. Invite the user to the site.

Turn off calls from the door station:

1. In the AXIS Companion 4 mobile app, go to **User**.
2. Go to **Notifications** and turn off **Door station calls**.

### Add cameras to your site

1. Connect the cameras to the recorders integrated PoE switch or an external PoE switch.
2. Go to  > **Cameras**.
3. Click **Add devices**.
4. Select the devices you want to add to your site.

If any devices are password-protected, then you must enter the password for them before they can be selected.

### Note

If you have devices that are not supported, then you can click **Read more** to find out why they are not supported.

5. Click **Next**.
6. Enter a password.



# AXIS Companion Eye L

## Daily use

---



This password is used for accessing the device webpages or offline mode in the AXIS Companion mobile app.

7. Click **Next**.
8. On the **Ready to install** page, there might be a list of cameras that need to be restored. If so, click the **Restore device** link to fix the issue on the device webpage.
9. Click **Finish** and wait while AXIS Companion configures the cameras.

### Note

The configuration may take several minutes.

## Remove a camera from your site

1. Go to  > **Cameras**.
2. On the row of the camera you want to remove, click  > **Remove**.
3. If the camera has ongoing recordings, select **Stop motion and continuous recording** to stop recordings.
4. Click **OK**.

# AXIS Companion Eye L

## Troubleshooting

---

### Troubleshooting

#### LED indicators

Status LED	Indication
Unlit	Connection and normal operation.
Green	Shows steady green for 10 seconds for normal operation after startup completed.
Amber	Steady during startup. Flashes during firmware upgrade or reset to factory default.
Amber/Red	Flashes amber/red if network connection is unavailable or lost.
Red	Firmware upgrade failure.

#### SD card slot

##### **NOTICE**

- Risk of damage to SD card. Do not use sharp tools, metal objects, or excessive force when inserting or removing the SD card. Use your fingers to insert and remove the card.
- Risk of data loss and corrupted recordings. Do not remove the SD card while the product is running. Unmount the SD card from the product's webpage before removal.

This product supports microSD/microSDHC/microSDXC cards.

For SD card recommendations, see [axiscompanion.com](http://axiscompanion.com).

 microSD, microSDHC, and microSDXC Logos are trademarks of SD-3C LLC. microSD, microSDHC, microSDXC are trademarks or registered trademarks of SD-3C, LLC in the United States, other countries or both.

#### Buttons

##### Control button

The control button is used for:

- Resetting the product to factory default settings. See *Hard reset a camera on page 19* or *Hard reset a recorder on page 20*

#### Technical issues, clues and solutions

Issue	Solution
I have no live view.	Go to <i>Fix common issues on page 19</i> .
My recordings are not available.	Go to <i>Fix common issues on page 19</i> .
I cannot connect to my cameras.	Go to <i>Fix common issues on page 19</i> .
I receive error notification: "No contact".	Go to <i>Fix common issues on page 19</i> .
My sites do not appear in my mobile app.	Make sure you have version 4 of the AXIS Companion mobile app.
My video stream is lagging.	Make sure that your graphics card is updated with the latest drivers.

# AXIS Companion Eye L

## Troubleshooting

---

### Fix common issues

Before you restart, configure or reset your devices, we recommend that you to save a system report.

See *Save a system report on page 20*.

1. Check that your cameras and recorder have power.
2. Check that you are connected to the internet.
3. Check that the network is working.
4. Check that the cameras are connected to the same network as the computer, unless you are remote.

Still not working?

5. Make sure that your cameras, recorder and AXIS Companion desktop app have the latest firmware and software updates.

See *Upgrade firmware on page 19*.

6. Restart the AXIS Companion desktop app.
7. Restart you cameras and recorder.

Still not working?

8. Make a hard reset on the cameras and the recorder, to completely put them back to factory default settings.

See *Hard reset a camera on page 19* and *Hard reset a recorder on page 20*.

9. Add the reset cameras to your site again.

Still not working?

10. Update your graphics card with the latest drivers.

Still not working?

11. Save a system report and contact *Axis technical support*.

See *Save a system report on page 20*.

### Upgrade firmware

New firmware updates bring you to the latest and improved set of features, functions, and security enhancements.

1. Go to the leader device webpage.
2. Go to **System > Maintenance** and click **Upgrade** under **Firmware upgrade**.
3. Follow the instructions on the screen.

### Hard reset a camera

#### Note

A hard reset will not affect your recordings.

#### Note

A hard reset will reset all the settings, including the IP address.

1. Select the camera you want to hard reset and remove it from the site.

# AXIS Companion Eye L

## Troubleshooting

---

See *Remove a camera from your site on page 17*.

2. Disconnect the power from the device.
3. Press and hold the control button on the device, and then reconnect the power.  
Keep the control button pressed for 15–30 seconds until the status LED indicator flashes amber.
4. Release the control button.  
The process is complete when the status LED indicator turns green.  
The product has now been reset to the factory default settings.
5. Add the camera to the site again, see *Add cameras to your site on page 16*.

### Hard reset a recorder

#### **▲WARNING**

Move the recorder very gently while it is switched on. Sudden moves or shocks may damage the hard drive.

#### **▲WARNING**

A hard reset will remove the saved encryption password for the hard drive. Failure to remember the encryption password for an encrypted hard drive will result in permanent loss of all recordings.

#### Note

A hard reset will reset all the settings, including the IP address.

1. Switch off the recorder:  
Press the power button on the front of the recorder for 4–5 seconds until you hear a beep.
2. Wait until the recorder is switched off, then turn it over to access the control button.
3. Press and hold the control button. Press and release the power button to start the recorder. Release the control button after 15–30 seconds when the LED indicator flashes amber.
4. Slowly put the recorder back in its place.
5. The process is complete when the status LED indicator turns green. The product has been reset to the factory default settings. If no DHCP server is available on the network, the default IP address is 192.168.0.90
6. Reset your cameras connected to the recorder. See *Hard reset a camera on page 19*.
7. If your hard drive is encrypted, then it must be mounted manually after the recorder is reset:
  - 7.1 Go to the device webpage.
  - 7.2 Go to **System > Storage** and click **Mount**.
  - 7.3 Enter the encryption password used when encrypting the hard drive.

### Save a system report



1. In AXIS Companion, go to  > **Save system report**.
2. When you register a new case at Axis Helpdesk, attach the system report.

