

## **AXIS M2025-LE Network Camera**

## **User Manual**

# AXIS M2025-LE Network Camera

## Table of Contents

---

<b>Solution overview</b> .....	3
<b>Installation</b> .....	4
<b>Product overview</b> .....	5
<b>Find the device on the network</b> .....	6
Browser support .....	6
<b>Access the device</b> .....	7
Set a new password for the root account .....	7
Secure passwords .....	7
<b>Additional settings</b> .....	8
Webpage overview .....	8
Image quality .....	10
Streaming and storage .....	12
Events .....	15
<b>Troubleshooting</b> .....	17
Reset to factory default settings .....	17
Firmware options .....	17
Check the current firmware .....	17
Upgrade the firmware .....	18
Technical issues, clues and solutions .....	18
Performance considerations .....	20
<b>Specifications</b> .....	21
LED indicators .....	21
SD card slot .....	21
Buttons .....	21
Connectors .....	21

# AXIS M2025-LE Network Camera

## Solution overview

---

### Solution overview

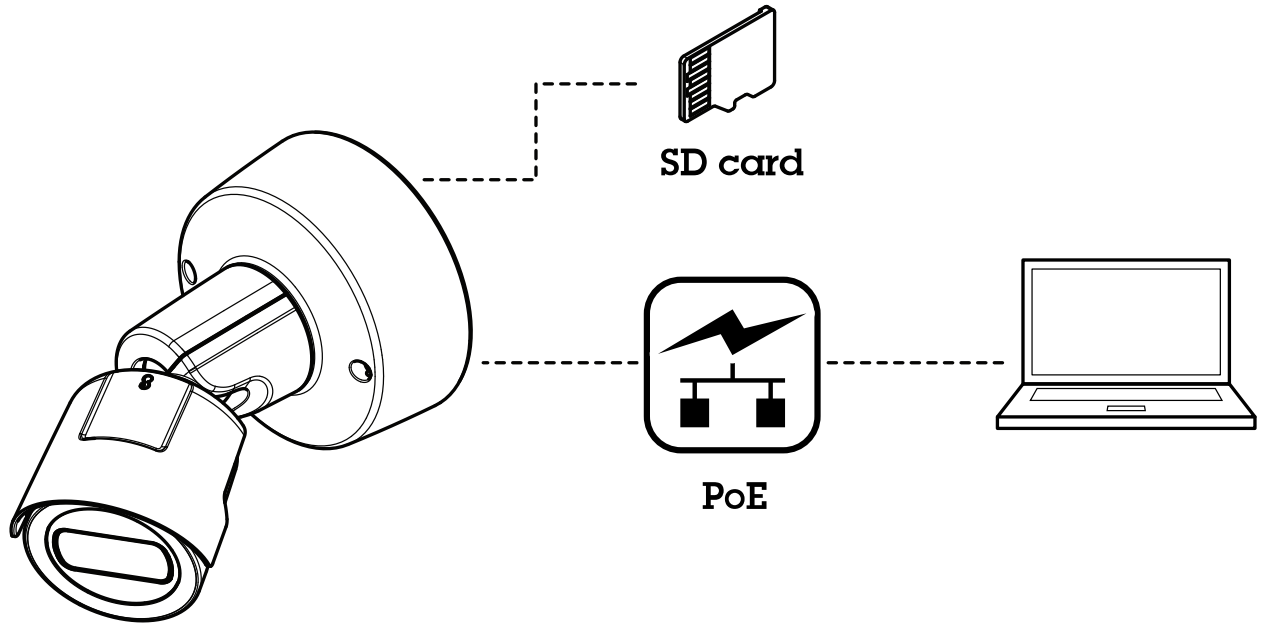

# AXIS M2025-LE Network Camera

## Installation

---

### Installation



To watch this video, go to the web version of this document.

[www.axis.com/products/online-manual/22482#t10170570](http://www.axis.com/products/online-manual/22482#t10170570)

*Installation video for the product.*

# AXIS M2025-LE Network Camera

## Product overview

---

### Product overview

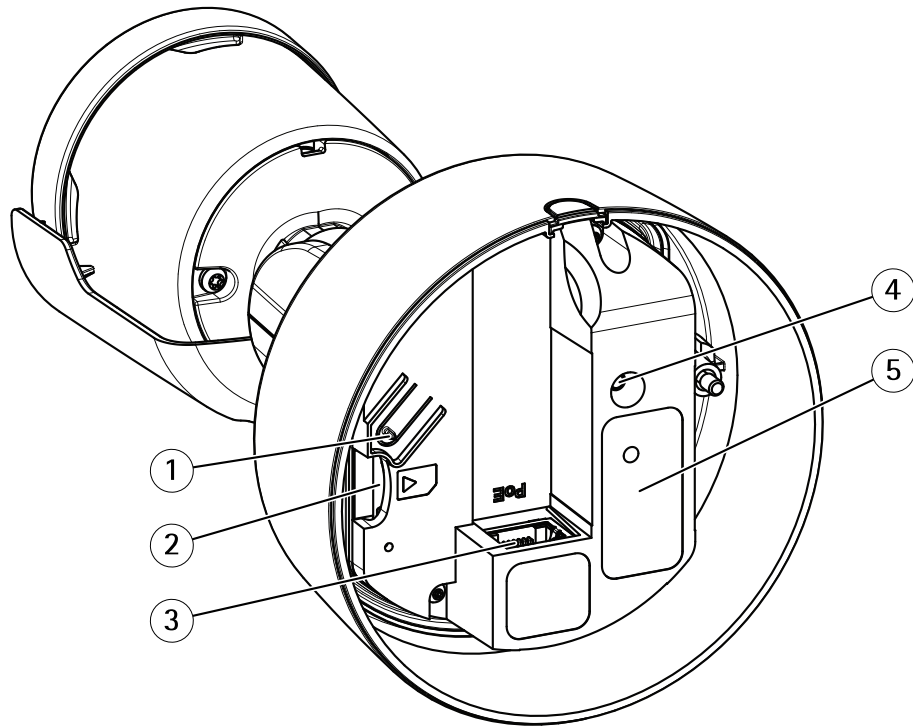

- 1 Control button
- 2 SD card slot
- 3 Network connector (PoE)
- 4 Status LED indicator
- 5 Part number (P/N) & Serial number (S/N)

For technical specifications, see *Specifications on page 21*.

# AXIS M2025-LE Network Camera

## Find the device on the network

---

### Find the device on the network

To find Axis devices on the network and assign them IP addresses in Windows®, use AXIS IP Utility or AXIS Device Manager. Both applications are free and can be downloaded from [axis.com/support](http://axis.com/support).

For more information about how to find and assign IP addresses, go to *How to assign an IP address and access your device*.

### Browser support

You can use the device with the following browsers:

	Chrome™	Firefox®	Edge™	Safari®
Windows®	recommended	recommended	x	
macOS®	recommended	recommended	x	x
Linux®	recommended	recommended	x	
Other operating systems	x	x	x	x*

*\*Supported in iOS and iPadOS*

If you need more information about recommended browsers, go to *AXIS OS Portal*.

# AXIS M2025-LE Network Camera

## Access the device

---

### Access the device

1. Open a browser and enter the IP address or host name of the Axis device.  
If you do not know the IP address, use AXIS IP Utility or AXIS Device Manager to find the device on the network.
2. Enter the username and password. If you access the device for the first time, you must set the root password. See *Set a new password for the root account on page 7*.
3. The live view page opens in your browser.

### Set a new password for the root account

#### Important

The default administrator username is **root**. If the password for root is lost, reset the device to factory default settings. See *Reset to factory default settings on page 17*



To watch this video, go to the web version of this document.

[www.axis.com/products/online-manual/22482#t10098905](http://www.axis.com/products/online-manual/22482#t10098905)

*Support tip: Password security confirmation check*

1. Type a password. Follow the instructions about secure passwords. See *Secure passwords on page 7*.
2. Retype the password to confirm the spelling.
3. Click **Create login**. The password has now been configured.

### Secure passwords

#### Important

Axis devices send the initially set password in clear text over the network. To protect your device after the first login, set up a secure and encrypted HTTPS connection and then change the password.

The device password is the primary protection for your data and services. Axis devices do not impose a password policy as they may be used in various types of installations.

To protect your data we strongly recommend that you:

- Use a password with at least 8 characters, preferably created by a password generator.
- Don't expose the password.
- Change the password at a recurring interval, at least once a year.

# AXIS M2025-LE Network Camera

## Additional settings

---

### Additional settings

### Webpage overview



- 1 Live view control bar
- 2 Live view
- 3 Product name
- 4 User information, color themes, and help
- 5 Video control bar
- 6 Settings toggle



# AXIS M2025-LE Network Camera

## Additional settings

---

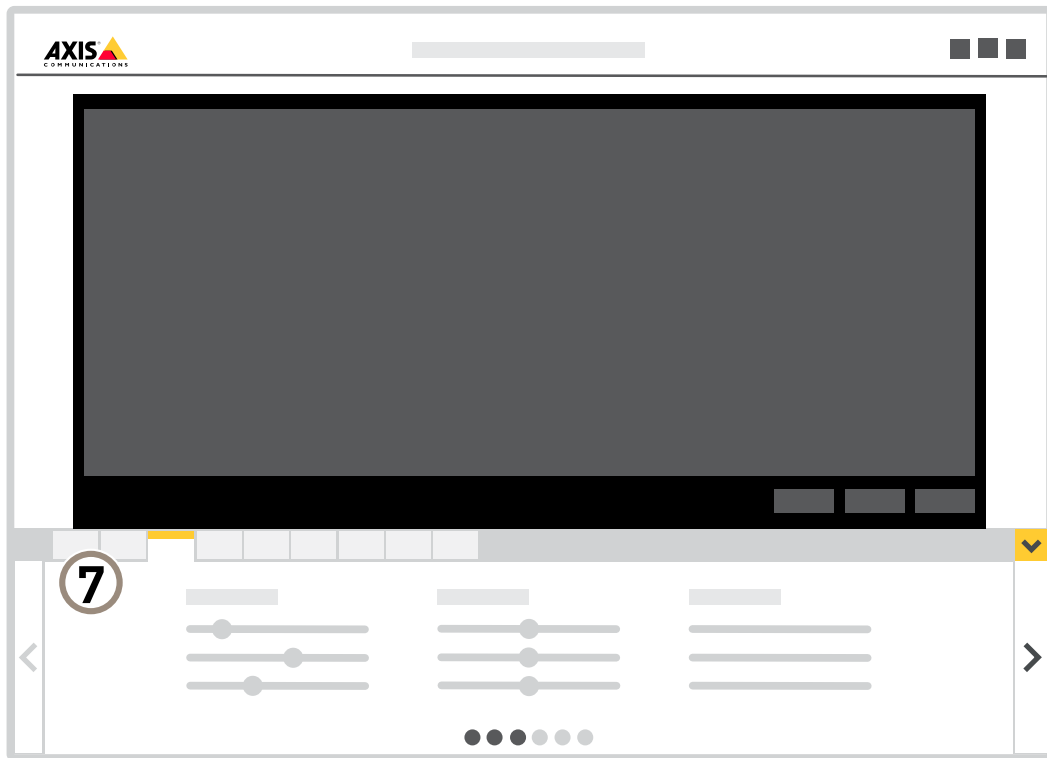

7 Settings tabs

### Need more help?

You can access the built-in help from the device's webpage. The help provides more detailed information on the device's features and their settings.

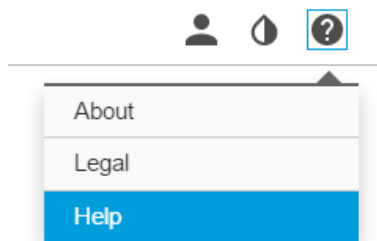

# AXIS M2025-LE Network Camera

## Additional settings

---

### Image quality

#### Select exposure mode

There are different exposure mode options in the camera that adjusts aperture, shutter speed, and gain to improve image quality for specific surveillance scenes. Go to **Settings > Image > Exposure** and select between the following exposure modes:

- For most use cases, select **Automatic** exposure.
- For environments with certain artificial lighting, for example fluorescent lighting, select **Flicker-free**.  
Select the same frequency as the power line frequency.
- For environments with certain artificial light and bright light, for example outdoors with fluorescent lighting at night and sun during daytime, select **Flicker-reduced**.  
Select the same frequency as the power line frequency.
- To lock the current exposure settings, select **Hold current**.

#### Benefit from IR light in low-light conditions using night mode

Your camera uses visible light to deliver color images during the day. As the available light diminishes, you can set the camera to automatically shift to night mode, in which the camera uses both visible light and near-infrared light to deliver black-and-white images. Since the camera uses more of the available light it can deliver brighter, more detailed, images.

1. Go to **Settings > Image > Day and night**, and make sure that the **IR cut filter** is set to **Auto**.
2. To determine at what light level you want the camera to shift to night mode, move the **Threshold** slider toward **Bright** or **Dark**.
3. Enable **Allow IR illumination** and **Synchronize IR illumination** to use the camera's IR light when night mode is activated.

#### Note

If you set the shift to night mode to occur when it's brighter, the image remains sharper as there will be less low-light noise. If you set the shift to occur when it's darker, the image colors are maintained for longer, but there will be more image blur due to low-light noise.

#### Reduce noise in low-light conditions

To reduce noise in low-light conditions, you can adjust one or more of the following settings:

- Adjust the trade-off between noise and motion blur. Go to **Settings > Image > Exposure** and move the **Blur-noise trade-off** slider toward **Low noise**.
- Set the exposure mode to automatic.

#### Note

A high max shutter value can result in motion blur.

- To slow down the shutter speed, set max shutter to the highest possible value.
- Reduce sharpness in the image.
- Open the aperture.

#### Handle scenes with strong backlight

Dynamic range is the difference in light levels in an image. In some cases the difference between the darkest and the brightest areas can be significant. The result is often an image where either the dark or the bright areas are visible. Wide dynamic range (WDR) makes both dark and bright areas of the image visible.

# AXIS M2025-LE Network Camera

## Additional settings

---



*Image without WDR.*



*Image with WDR.*

### Note

- WDR can cause artifacts in the image.
  - WDR may not be available for all capture modes.
1. Go to **Settings > Image > Wide dynamic range**.
  2. Turn on WDR.
  3. Use the **Local contrast** slider to adjust the amount of WDR.
  4. If you still have problems, go to **Exposure** and adjust the **Exposure zone** to cover the area of interest.

Find out more about WDR and how to use it at [axis.com/web-articles/wdr](https://axis.com/web-articles/wdr).

### Monitor long and narrow areas

Use corridor format to better utilize the full field of view in a long and narrow area, for example a staircase, hallway, road, or tunnel.

# AXIS M2025-LE Network Camera

## Additional settings

---

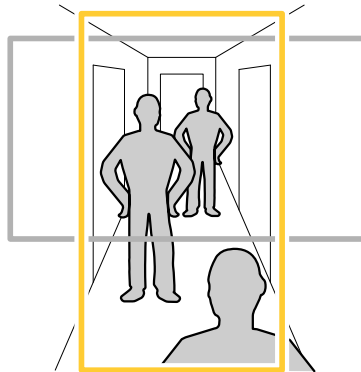

1. Depending on your device, turn the camera or the 3-axis lens in the camera 90° or 270°.

### Note

Make sure to aim IR LEDs away from walls or weathershields.

2. If the device doesn't have automatic rotation of the view, log in to the webpage and go to **Settings > System > Orientation**.
3. Click .
4. Rotate the view 90° or 270°.

Find out more at [axis.com/axis-corridor-format](https://axis.com/axis-corridor-format).

## Streaming and storage

### Bitrate control

With bitrate control, you can manage the bandwidth consumption of your video stream.

#### Variable bitrate (VBR)

With variable bitrate, the bandwidth consumption varies based on the level of activity in the scene. The more activity in the scene, the more bandwidth you need. You are guaranteed constant image quality but it requires storage margins.

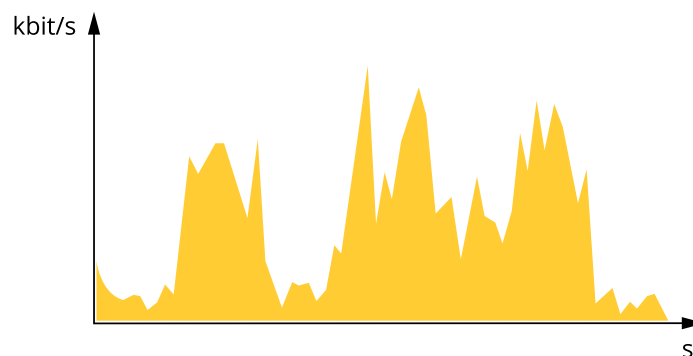

#### Maximum bitrate (MBR)

With maximum bitrate, you can set a target bitrate to handle bitrate limitations in your system. You may see a decline in image quality or frame rate when the instantaneous bitrate is kept below the specified target bitrate. You can choose to either prioritize image quality or frame rate. We recommend that you configure the target bitrate to a higher value than the expected bitrate. This gives you a margin for additional complexity that needs to be captured.

# AXIS M2025-LE Network Camera

## Additional settings

---

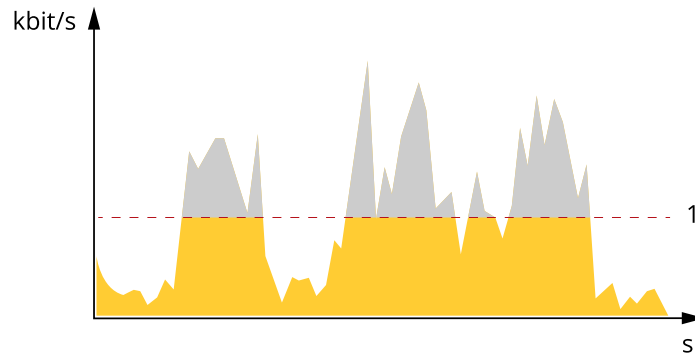

1 Target bitrate

### Average bitrate (ABR)

With average bitrate, the bitrate is automatically adjusted over a longer timescale. This is so you can meet the specified target and provide the best video quality based on your available storage. Bitrate is higher in scenes with a lot of activity, compared to static scenes. You are more likely to get better image quality when needed when using the average bitrate option. You can define the total storage required to store the video stream for a specified amount of time (retention time) when image quality is adjusted to meet the specified target bitrate. Specify the average bitrate settings in one of the following ways:

- To calculate the estimated storage need, set the target bitrate and the retention time.
- To calculate the average bitrate, based on available storage and required retention time, use the target bitrate calculator.

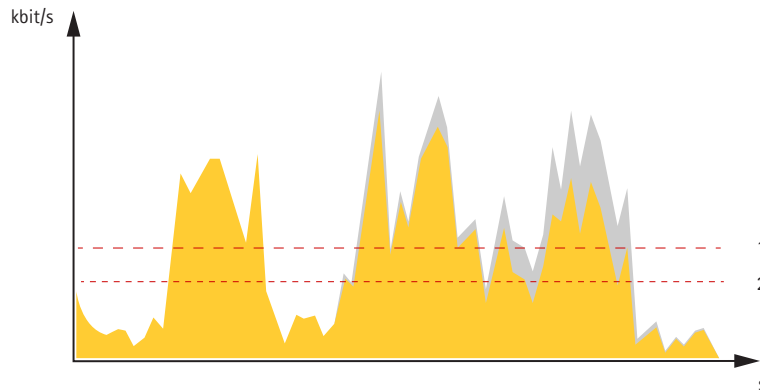

1 Target bitrate  
2 Actual average bitrate

You can also turn on maximum bitrate and specify a target bitrate within the average bitrate option.

# AXIS M2025-LE Network Camera

## Additional settings

---

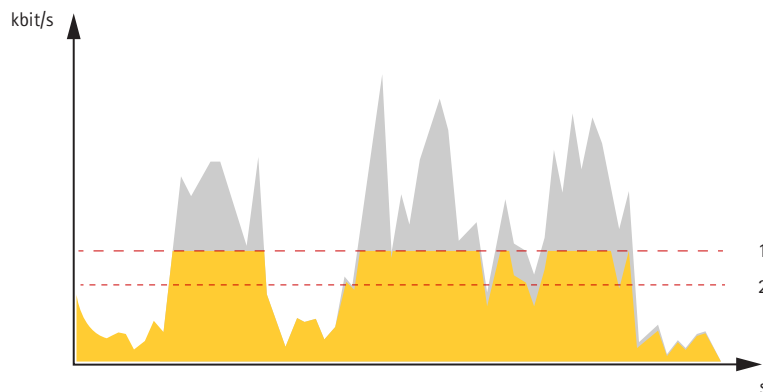

- 1 Target bitrate
- 2 Actual average bitrate

### Video compression formats

Decide which compression method to use based on your viewing requirements, and on the properties of your network. The available options are:

#### Motion JPEG

Motion JPEG, or MJPEG, is a digital video sequence that is made up of a series of individual JPEG images. These images are then displayed and updated at a rate sufficient to create a stream that shows constantly updated motion. For the viewer to perceive motion video the rate must be at least 16 image frames per second. Full motion video is perceived at 30 (NTSC) or 25 (PAL) frames per second.

The Motion JPEG stream uses considerable amounts of bandwidth, but provides excellent image quality and access to every image contained in the stream.

#### H.264 or MPEG-4 Part 10/AVC

##### Note

H.264 is a licensed technology. The Axis product includes one H.264 viewing client license. To install additional unlicensed copies of the client is prohibited. To purchase additional licenses, contact your Axis reseller.

H.264 can, without compromising image quality, reduce the size of a digital video file by more than 80% compared to the Motion JPEG format and by as much as 50% compared to the MPEG-4 standard. This means that less network bandwidth and storage space are required for a video file. Or seen another way, higher video quality can be achieved for a given bitrate.

### Reduce bandwidth and storage

##### Important

If you reduce the bandwidth it can result in loss of details in the picture.

1. Go to live view and select H.264.
2. Go to **Settings > Stream**.
3. Do one or more of the following:
  - Turn on the Zipstream functionality and select the desired level.
  - Turn on dynamic GOP and set a high GOP length value.
  - Increase the compression.
  - Turn on dynamic FPS.

# AXIS M2025-LE Network Camera

## Additional settings

---

### Set up network storage

To store recordings on the network, you need to set up your network storage.

1. Go to **Settings > System > Storage**.
2. Click **Setup** under **Network storage**.
3. Enter the IP address of the host server.
4. Enter the name of the shared location on the host server.
5. Move the switch if the share requires a login, and enter username and password.
6. Click **Connect**.

### Add audio to your recording

Turn on audio:

1. Go to **Settings > Audio** and turn on **Allow audio**.
2. Go to **Input > Type** and select your audio source.

Edit the stream profile which is used for the recording:

3. Go to **Settings > Stream** and click **Stream profiles**.
4. Select the stream profile and click **Audio**.
5. Select the checkbox and select **Include**.
6. Click **Save**.
7. Click **Close**.

### Record and watch video

To record video you must first set up network storage, see *Set up network storage on page 15*, or have an SD card installed.

#### Record video

1. Go to the live view.
2. To start a recording, click **Record**. Click again to stop the recording.

#### Watch video

1. Click **Storage > Go to recordings**.
2. Select your recording in the list and it will play automatically.

## Events

### Set up rules and alerts

You can create rules to make your device perform an action when certain events occur. A rule consists of conditions and actions. The conditions can be used to trigger the actions. For example, the device can start a recording or send an email when it detects motion, or show an overlay text while the device is recording.

# AXIS M2025-LE Network Camera

## Additional settings

---

### Record video when the camera detects motion

This example explains how to set up the camera to start recording to the SD card five seconds before it detects motion and to stop one minute after.



To watch this video, go to the web version of this document.

[www.axis.com/products/online-manual/22482#t10106619](http://www.axis.com/products/online-manual/22482#t10106619)

*How to record a video stream when the camera detects motion*

Make sure that AXIS Video Motion Detection is running:

1. Go to **Settings > Apps > AXIS Video Motion Detection**.
2. Start the application if it is not already running.
3. Make sure you have set up the application according to your needs. If you need help, see the *user manual for AXIS Video Motion Detection 4*.

Create a rule:

1. Go to **Settings > System > Events** and add a rule.
2. Type a name for the rule.
3. In the list of conditions, under **Application**, select **AXIS Video Motion Detection (VMD)**.
4. In the list of actions, under **Recordings**, select **Record video while the rule is active**.
5. Select an existing stream profile or create a new one.
6. Set the prebuffer time to 5 seconds.
7. Set the postbuffer time to 60 seconds.
8. In the list of storage options, select **SD card**.
9. Click **Save**.



# AXIS M2025-LE Network Camera

## Troubleshooting

---

### Troubleshooting

#### Reset to factory default settings

##### **⚠WARNING**

 IR emitted from this product. Do not look at operating lamp.

##### **Important**

Reset to factory default should be used with caution. A reset to factory default resets all settings, including the IP address, to the factory default values.

To reset the product to the factory default settings:

1. Disconnect power from the product.
2. Press and hold the control button while reconnecting power. See *Product overview on page 5*.
3. Keep the control button pressed for 15–30 seconds until the status LED indicator flashes amber.
4. Release the control button. The process is complete when the status LED indicator turns green. The product has been reset to the factory default settings. If no DHCP server is available on the network, the default IP address is 192.168.0.90.
5. Use the installation and management software tools to assign an IP address, set the password, and access the video stream.

The installation and management software tools are available from the support pages on [axis.com/support](https://axis.com/support).

It is also possible to reset parameters to factory default through the web interface. Go to **Settings > System > Maintenance** and click **Default**.

#### Firmware options

Axis offers product firmware management according to either the active track or the long-term support (LTS) tracks. Being on the active track means continuously getting access to all the latest product features, while the LTS tracks provide a fixed platform with periodic releases focused mainly on bug fixes and security updates.

Using firmware from the active track is recommended if you want to access the newest features, or if you use Axis end-to-end system offerings. The LTS tracks are recommended if you use third-party integrations, which are not continuously validated against the latest active track. With LTS, the products can maintain cybersecurity without introducing any significant functional changes or affecting any existing integrations. For more detailed information about Axis product firmware strategy, go to [axis.com/support/firmware](https://axis.com/support/firmware).

#### Check the current firmware

Firmware is the software that determines the functionality of network devices. One of your first actions when troubleshooting a problem should be to check the current firmware version. The latest version may contain a correction that fixes your particular problem.

To check the current firmware:

1. Go to the product's webpage.
2. Click the help menu  .
3. Click **About**.

# AXIS M2025-LE Network Camera

## Troubleshooting

---

### Upgrade the firmware

#### Important

Preconfigured and customized settings are saved when the firmware is upgraded (provided that the features are available in the new firmware) although this is not guaranteed by Axis Communications AB.

#### Important

Make sure the product remains connected to the power source throughout the upgrade process.

#### Note

When you upgrade the product with the latest firmware in the active track, the product receives the latest functionality available. Always read the upgrade instructions and release notes available with each new release before upgrading the firmware. To find the latest firmware and the release notes, go to [axis.com/support/firmware](https://axis.com/support/firmware).

AXIS Device Manager can be used for multiple upgrades. Find out more at [axis.com/products/axis-device-manager](https://axis.com/products/axis-device-manager).



To watch this video, go to the web version of this document.

[www.axis.com/products/online-manual/22482#t10095327](https://www.axis.com/products/online-manual/22482#t10095327)

*How to upgrade the firmware*

1. Download the firmware file to your computer, available free of charge at [axis.com/support/firmware](https://axis.com/support/firmware).
2. Log in to the product as an administrator.
3. Go to **Settings > System > Maintenance**. Follow the instructions on the page. When the upgrade has finished, the product restarts automatically.

### Technical issues, clues and solutions

If you can't find what you're looking for here, try the troubleshooting section at [axis.com/support](https://axis.com/support).

#### Problems upgrading the firmware

---

Firmware upgrade failure	If the firmware upgrade fails, the device reloads the previous firmware. The most common reason is that the wrong firmware file has been uploaded. Check that the name of the firmware file corresponds to your device and try again.
--------------------------	---

#### Problems setting the IP address

---

The device is located on a different subnet	If the IP address intended for the device and the IP address of the computer used to access the device are located on different subnets, you cannot set the IP address. Contact your network administrator to obtain an IP address.
---	---

# AXIS M2025-LE Network Camera

## Troubleshooting

---

The IP address is being used by another device	Disconnect the Axis device from the network. Run the ping command (in a Command/DOS window, type <code>ping</code> and the IP address of the device): <ul style="list-style-type: none"><li>If you receive: <code>Reply from &lt;IP address&gt;: bytes=32; time=10...</code> this means that the IP address may already be in use by another device on the network. Obtain a new IP address from the network administrator and reinstall the device.</li><li>If you receive: <code>Request timed out</code>, this means that the IP address is available for use with the Axis device. Check all cabling and reinstall the device.</li></ul>
Possible IP address conflict with another device on the same subnet	The static IP address in the Axis device is used before the DHCP server sets a dynamic address. This means that if the same default static IP address is also used by another device, there may be problems accessing the device.

### The device cannot be accessed from a browser

---

Cannot log in	When HTTPS is enabled, ensure that the correct protocol (HTTP or HTTPS) is used when attempting to log in. You may need to manually type <code>http</code> or <code>https</code> in the browser's address field.  If the password for the user <code>root</code> is lost, the device must be reset to the factory default settings. See <i>Reset to factory default settings on page 17</i> .
The IP address has been changed by DHCP	IP addresses obtained from a DHCP server are dynamic and may change. If the IP address has been changed, use AXIS IP Utility or AXIS Device Manager to locate the device on the network. Identify the device using its model or serial number, or by the DNS name (if the name has been configured).  If required, a static IP address can be assigned manually. For instructions, go to <a href="http://axis.com/support">axis.com/support</a> .
Certificate error when using IEEE 802.1X	For authentication to work properly, the date and time settings in the Axis device must be synchronized with an NTP server. Go to <b>Settings &gt; System &gt; Date and time</b> .

### The device is accessible locally but not externally

---

To access the device externally, we recommend using one of the following applications for Windows®:

- AXIS Companion: free of charge, ideal for small systems with basic surveillance needs.
- AXIS Camera Station: 30-day trial version free of charge, ideal for small to mid-size systems.

For instructions and download, go to [axis.com/vms](http://axis.com/vms).

### Problems with streaming

---

Multicast H.264 only accessible by local clients	Check if your router supports multicasting, or if the router settings between the client and the device need to be configured. The TTL (Time To Live) value may need to be increased.
No multicast H.264 displayed in the client	Check with your network administrator that the multicast addresses used by the Axis device are valid for your network.  Check with your network administrator to see if there is a firewall preventing viewing.
Poor rendering of H.264 images	Ensure that your graphics card is using the latest driver. The latest drivers can usually be downloaded from the manufacturer's website.
Color saturation is different in H.264 and Motion JPEG	Modify the settings for your graphics adapter. Go to the adapter's documentation for more information.
Lower frame rate than expected	<ul style="list-style-type: none"><li>See <i>Performance considerations on page 20</i>.</li><li>Reduce the number of applications running on the client computer.</li><li>Limit the number of simultaneous viewers.</li><li>Check with the network administrator that there is enough bandwidth available.</li><li>Lower the image resolution.</li><li>The maximum frames per second is dependent on the utility frequency (60/50 Hz) of the Axis device.</li></ul>

# AXIS M2025-LE Network Camera

## Troubleshooting

---

### Performance considerations

When setting up your system, it is important to consider how various settings and situations affect the performance. Some factors affect the amount of bandwidth (the bitrate) required, others can affect the frame rate, and some affect both. If the load on the CPU reaches its maximum, this also affects the frame rate.

The following factors are the most important to consider:

- High image resolution or lower compression levels result in images containing more data which in turn affects the bandwidth.
- Rotating the image in the GUI will increase the product's CPU load.
- Access by large numbers of Motion JPEG or unicast H.264 clients affects the bandwidth.
- Simultaneous viewing of different streams (resolution, compression) by different clients affects both frame rate and bandwidth.

Use identical streams wherever possible to maintain a high frame rate. Stream profiles can be used to ensure that streams are identical.

- Accessing Motion JPEG and H.264 video streams simultaneously affects both frame rate and bandwidth.
- Heavy usage of event settings affects the product's CPU load which in turn affects the frame rate.
- Using HTTPS may reduce frame rate, in particular if streaming Motion JPEG.
- Heavy network utilization due to poor infrastructure affects the bandwidth.
- Viewing on poorly performing client computers lowers perceived performance and affects frame rate.
- Running multiple AXIS Camera Application Platform (ACAP) applications simultaneously may affect the frame rate and the general performance.

# AXIS M2025-LE Network Camera

## Specifications

---

### Specifications

#### LED indicators

Status LED	Indication
Unlit	Connection and normal operation.
Green	Shows steady green for 10 seconds for normal operation after startup completed.
Amber	Steady during startup. Flashes during firmware upgrade or reset to factory default.
Amber/Red	Flashes amber/red if network connection is unavailable or lost.
Red	Firmware upgrade failure.

#### SD card slot

##### **NOTICE**

- Risk of damage to SD card. Do not use sharp tools, metal objects, or excessive force when inserting or removing the SD card. Use your fingers to insert and remove the card.
- Risk of data loss and corrupted recordings. Do not remove the SD card while the product is running. Unmount the SD card from the product's webpage before removal.

This product supports microSD/microSDHC/microSDXC cards.

For SD card recommendations, see [axis.com](http://axis.com).



microSD, microSDHC, and microSDXC Logos are trademarks of SD-3C LLC. microSD, microSDHC, microSDXC are trademarks or registered trademarks of SD-3C, LLC in the United States, other countries or both.

#### Buttons

##### Control button

The control button is used for:

- Resetting the product to factory default settings. See *Reset to factory default settings on page 17*.

#### Connectors

##### Network connector

RJ45 Ethernet connector with Power over Ethernet (PoE).

