

## **AXIS M5525-E PTZ Network Camera**

**User manual**

# AXIS M5525-E PTZ Network Camera

## Table of Contents

---

<b>Product overview</b> .....	3
<b>How to connect a microphone to the camera</b> .....	4
<b>Find the device on the network</b> .....	5
Access the device .....	5
Secure passwords .....	5
<b>Additional settings</b> .....	7
Need more help? .....	7
Image quality .....	7
Privacy masks .....	9
Overlays .....	10
Pan, tilt, and zoom (PTZ) .....	11
Streaming and storage .....	11
Events .....	12
Applications .....	16
<b>Troubleshooting</b> .....	17
Reset to factory default settings .....	17
Check the current firmware .....	17
Upgrade the firmware .....	17
Technical issues, clues and solutions .....	18
Performance considerations .....	19
<b>Specifications</b> .....	21
LED indicators .....	21
SD card slot .....	21
Buttons .....	21
Connectors .....	21

# AXIS M5525-E PTZ Network Camera

## Product overview

---

### Product overview

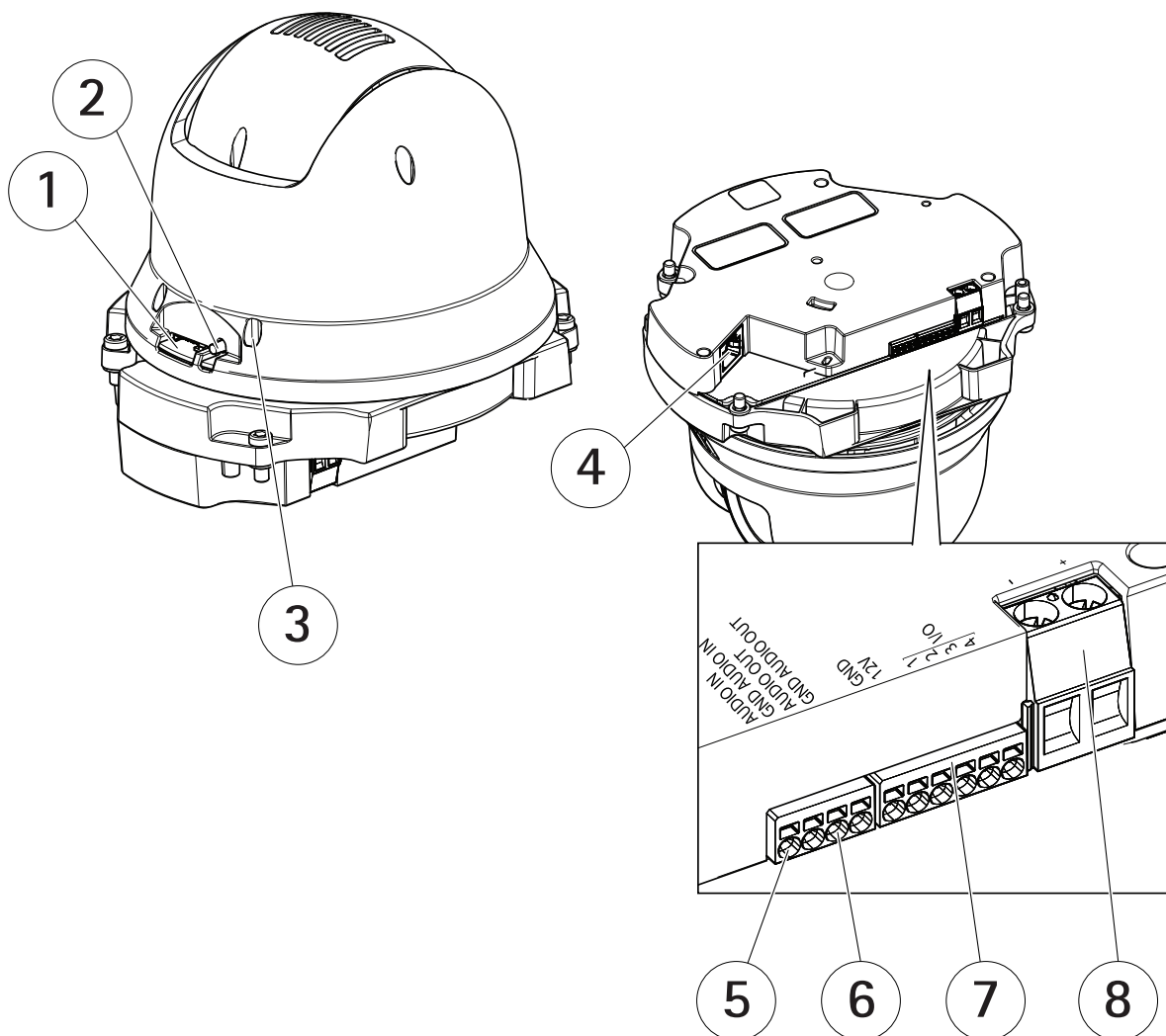

- 1 SD card slot (microSD)
- 2 Control button
- 3 Status LED
- 4 RJ45 connector
- 5 Audio in
- 6 Audio out
- 7 I/O connector
- 8 Power connector

# AXIS M5525-E PTZ Network Camera

## How to connect a microphone to the camera

---

### How to connect a microphone to the camera

This example explains how to connect a microphone to the camera using an audio extension cable.

#### Required hardware

- AXIS T8351 Mk II Microphone 3.5 mm
- AXIS Audio Extension Cable B

#### Note

- To avoid noise, don't run the cable close to or in parallel with other cables.
- To avoid noise, cut the cable as short as possible.
- To maintain IP66 rating, make sure you keep the jack inside the housing.

#### Connect the cables

1. Keep the 3.5 mm jack and cut the audio extension cable.
2. Strip the outer cable insulation.
3. Strip the inner wire insulation.
4. Twist the audio wires (with insulation) together.
5. Twist the grounding wires (without insulation) together.
6. Connect the audio wires to the AUDIO IN pin on the camera. See *Product overview on page 3*.
7. Connect the grounding wires to the GND AUDIO IN pin on the camera.
8. Connect the microphone to the jack of the audio extension cable.
9. Turn on audio and adjust other audio settings in the camera's webpage.

# AXIS M5525-E PTZ Network Camera

## Find the device on the network

---

### Find the device on the network

To find Axis devices on the network and assign them IP addresses in Windows®, use AXIS IP Utility or AXIS Device Manager. Both applications are free and can be downloaded from [axis.com/support](http://axis.com/support).

For more information about how to find and assign IP addresses, go to *How to assign an IP address and access your device*.

### Access the device

1. Open a browser and enter the IP address or host name of the Axis device.  
If you do not know the IP address, use AXIS IP Utility or AXIS Device Manager to find the device on the network.
2. Enter the username and password. If you access the device for the first time, you must set the root password. See *Set a new password for the root account on page 5*.
3. The live view page opens in your browser.

### Secure passwords

#### Important

Axis devices send the initially set password in clear text over the network. To protect your device after the first login, set up a secure and encrypted HTTPS connection and then change the password.

The device password is the primary protection for your data and services. Axis devices do not impose a password policy as they may be used in various types of installations.

To protect your data we strongly recommend that you:

- Use a password with at least 8 characters, preferably created by a password generator.
- Don't expose the password.
- Change the password at a recurring interval, at least once a year.

### Set a new password for the root account

#### Important

The default administrator username is **root**. If the password for root is lost, reset the device to factory default settings. See *Reset to factory default settings on page 17*



To watch this video, go to the web version of this document.

[help.axis.com/?&pid=37672&section=set-a-new-password-for-the-root-account](http://help.axis.com/?&pid=37672&section=set-a-new-password-for-the-root-account)

*Support tip: Password security confirmation check*

1. Type a password. Follow the instructions about secure passwords. See *Secure passwords on page 5*.

# AXIS M5525-E PTZ Network Camera

## Find the device on the network

---

2. Retype the password to confirm the spelling.
3. Click **Create login**. The password has now been configured.

# AXIS M5525-E PTZ Network Camera

## Additional settings

---

### Additional settings

#### Need more help?

You can access the built-in help from the device's webpage. The help provides more detailed information on the device's features and their settings.

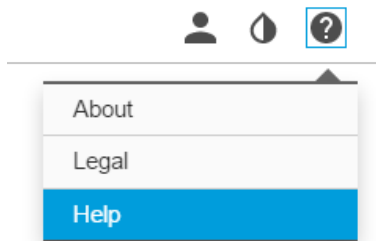

#### Image quality

##### Select exposure mode

There are different exposure mode options in the camera that adjusts aperture, shutter speed, and gain to improve image quality for specific surveillance scenes. Go to **Settings > Image > Exposure** and select between the following exposure modes:

- For most use cases, select **Automatic** exposure.
- For environments with certain artificial lighting, for example fluorescent lighting, select **Flicker-free**.  
Select the same frequency as the power line frequency.
- For environments with certain artificial light and bright light, for example outdoors with fluorescent lighting at night and sun during daytime, select **Flicker-reduced**.  
Select the same frequency as the power line frequency.
- To lock the current exposure settings, select **Hold current**.

##### Benefit from IR light in low-light conditions using night mode

Your camera uses visible light to deliver color images during the day. As the available light diminishes, you can set the camera to automatically shift to night mode, in which the camera uses both visible light and near-infrared light to deliver black-and-white images. Since the camera uses more of the available light it can deliver brighter, more detailed, images.

1. Go to **Settings > Image > Day and night**, and make sure that the **IR cut filter** is set to **Auto**.

##### Handle scenes with strong backlight

Dynamic range is the difference in light levels in an image. In some cases the difference between the darkest and the brightest areas can be significant. The result is often an image where either the dark or the bright areas are visible. Wide dynamic range (WDR) makes both dark and bright areas of the image visible.

# AXIS M5525-E PTZ Network Camera

## Additional settings

---



*Image without WDR.*



*Image with WDR.*

### Note

- WDR can cause artifacts in the image.
  - WDR may not be available for all capture modes.
1. Go to **Settings > Image > Wide dynamic range**.
  2. Turn on WDR.
  3. Use the **Local contrast** slider to adjust the amount of WDR.
  4. If you still have problems, go to **Exposure** and adjust the **Exposure zone** to cover the area of interest.

Find out more about WDR and how to use it at [axis.com/web-articles/wdr](https://axis.com/web-articles/wdr).

### Verify the pixel resolution

To verify that a defined part of the image contains enough pixels to, for example, recognize the face of a person, you can use the pixel counter.



# AXIS M5525-E PTZ Network Camera

## Additional settings

---

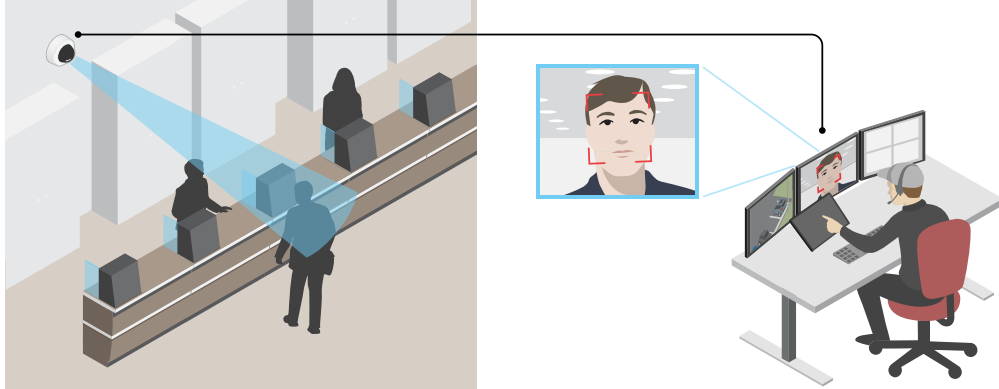

1. Go to **Settings > System > Orientation**.

2. Click  .

3. In the camera's live view, adjust the size and position of the rectangle around the area of interest, for example where you expect faces to appear.

You can see the number of pixels for each of the rectangle's sides (X and Y), and decide if the values are enough for your needs.

## Privacy masks

A privacy mask is a user-defined area that prevents users from viewing a part of the monitored area. In the video stream, privacy masks appear as blocks of solid color.

The privacy mask is relative to the pan, tilt, and zoom coordinates, so regardless of where you point the camera, the privacy mask covers the same place or object.

You'll see the privacy mask on all snapshots, recorded video, and live streams.

You can use the VAPIX® application programming interface (API) to hide the privacy masks.

### Important

If you use multiple privacy masks it may affect the product's performance.

You can create several privacy masks. The maximum number of masks depends on the complexity of all the masks combined. The more anchor points in each mask, the fewer masks you can create. Each mask can have 3 to 10 anchor points.

## Hide parts of the image with privacy masks

You can create one or several privacy masks to hide parts of the image.

# AXIS M5525-E PTZ Network Camera

## Additional settings

---



To watch this video, go to the web version of this document.  
[help.axis.com/?&tpiald=37672&tsection=hide-parts-of-the-image-with-privacy-masks](http://help.axis.com/?&tpiald=37672&tsection=hide-parts-of-the-image-with-privacy-masks)

*How to create a privacy mask*

1. Go to **Settings > Privacy mask**.
2. Click **New**.
3. Adjust the size, color, and name of the privacy mask according to your needs.



To watch this video, go to the web version of this document.  
[help.axis.com/?&tpiald=37672&tsection=hide-parts-of-the-image-with-privacy-masks](http://help.axis.com/?&tpiald=37672&tsection=hide-parts-of-the-image-with-privacy-masks)

*How to change the appearance of the mask*

## Overlays

Overlays are superimposed over the video stream. They are used to provide extra information during recordings, such as a timestamp, or during product installation and configuration. You can add either text or an image.

### Show a text overlay in the video stream when the device detects motion

This example explains how to display the text "Motion detected" when the device detects motion.

Make sure that AXIS Video Motion Detection is running:

1. Go to **Settings > Apps > AXIS Video Motion Detection**.
2. Start the application if it is not already running.
3. Make sure you have set up the application according to your needs. If you need help, see the *user manual for AXIS Video Motion Detection 4*.

Add the overlay text:

4. Go to **Settings > Overlay**.
5. Select **Create overlay** and select **Text overlay**.
6. Enter #D in the text field.
7. Choose text size and appearance.
8. To position the text overlay, choose **Custom** or one of the presets.

# AXIS M5525-E PTZ Network Camera

## Additional settings

---

Create an action rule:

9. Go to **Settings > System > Events > Action rules**.
10. Create an action rule with **AXIS Video Motion Detection** as trigger.
11. From the list of actions, select **Overlay text**.
12. Type "Motion detected".
13. Set the duration.

### Note

If you update the overlay text it will be automatically updated on all video streams dynamically.

## Pan, tilt, and zoom (PTZ)

### Limit the pan, tilt, and zoom movements

If there are parts of the scene that you don't want the camera to reach, you can limit the pan, tilt, and zoom movements. For example, you want to protect the privacy of residents in an apartment building, which is located close to a parking lot that you intend to monitor. To limit the movements, go to **Settings > PTZ > Limits**.

## Streaming and storage

### Video compression formats

Decide which compression method to use based on your viewing requirements, and on the properties of your network. The available options are:

#### Motion JPEG

Motion JPEG, or MJPEG, is a digital video sequence that is made up of a series of individual JPEG images. These images are then displayed and updated at a rate sufficient to create a stream that shows constantly updated motion. For the viewer to perceive motion video the rate must be at least 16 image frames per second. Full motion video is perceived at 30 (NTSC) or 25 (PAL) frames per second.

The Motion JPEG stream uses considerable amounts of bandwidth, but provides excellent image quality and access to every image contained in the stream.

#### H.264 or MPEG-4 Part 10/AVC

### Note

H.264 is a licensed technology. The Axis product includes one H.264 viewing client license. To install additional unlicensed copies of the client is prohibited. To purchase additional licenses, contact your Axis reseller.

H.264 can, without compromising image quality, reduce the size of a digital video file by more than 80% compared to the Motion JPEG format and by as much as 50% compared to older MPEG formats. This means that less network bandwidth and storage space are required for a video file. Or seen another way, higher video quality can be achieved for a given bitrate.

### Reduce bandwidth and storage

### Important

If you reduce the bandwidth it can result in loss of details in the picture.

1. Go to live view and select **H.264**.
2. Go to **Settings > Stream**.
3. Do one or more of the following:

# AXIS M5525-E PTZ Network Camera

## Additional settings

---

- Turn on the Zipstream functionality and select the desired level.
- Turn on dynamic GOP and set a high GOP length value.
- Increase the compression.
- Turn on dynamic FPS.

### Set up network storage

To store recordings on the network, you need to set up your network storage.

1. Go to **Settings > System > Storage**.
2. Click **Setup** under **Network storage**.
3. Enter the IP address of the host server.
4. Enter the name of the shared location on the host server.
5. Move the switch if the share requires a login, and enter username and password.
6. Click **Connect**.

### Add audio to your recording

Turn on audio:

1. Go to **Settings > Audio** and turn on **Allow audio**.
2. Go to **Input > Type** and select your audio source.

Edit the stream profile which is used for the recording:

3. Go to **Settings > Stream** and click **Stream profiles**.
4. Select the stream profile and click **Audio**.
5. Select the checkbox and select **Include**.
6. Click **Save**.
7. Click **Close**.

## Events

### Set up rules for events

You can create rules to make your device perform an action when certain events occur. A rule consists of conditions and actions. The conditions can be used to trigger the actions. For example, the device can start a recording or send an email when it detects motion, or show an overlay text while the device is recording.

To learn more, check out our guide *Get started with rules for events*.

### Direct the camera to a preset position when the camera detects motion

This example explains how to set up the camera to go to a preset position when it detects motion in the image.

Make sure that AXIS Video Motion Detection is running:

1. Go to **Settings > Apps > AXIS Video Motion Detection**.
2. Start the application if it is not already running.

# AXIS M5525-E PTZ Network Camera

## Additional settings

---

3. Make sure you have set up the application according to your needs. If you need help, see the *user manual for AXIS Video Motion Detection 4*.

Add a preset position:

Go to **Settings > PTZ** and set where you want the camera to be directed by creating a preset position.

Create an action rule:

1. Go to **Settings > System > Events > Action rules** and add an action rule.
2. Type a name for the action rule.
3. From the list of triggers, select **Applications** and then select **AXIS Video Motion Detection (VMD)**.
4. From the list of actions, select **PTZ Control** and then select **Preset Position**.
5. Select the preset position you want the camera to go to.
6. Click **Ok**.

### Record video when a PIR detector senses motion

This example explains how to connect an Axis PIR detector to the camera, and set up the camera to start recording when the detector senses motion.

#### Required hardware

- 3-wire cable (ground, power, I/O)
- Axis PIR detector

#### **NOTICE**

Disconnect the camera from power before connecting the wires. Reconnect to power after all connections are done.

#### Connect the wires to the camera's I/O connector

##### Note

For information on the I/O connector, see *Connectors on page 21*.

1. Connect the ground wire to pin 1 (GND/-).
2. Connect the power wire to pin 2 (12V DC output).
3. Connect the I/O wire to pin 3 (I/O input).

#### Connect the wires to the PIR detector's I/O connector

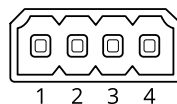

1. Connect the other end of the ground wire to pin 1 (GND/-).
2. Connect the other end of the power wire to pin 2 (DC input/+).
3. Connect the other end of the I/O wire to pin 3 (I/O output).

#### Configure the I/O port in the camera's webpage

1. Go to **Settings > System > I/O ports**.

# AXIS M5525-E PTZ Network Camera

## Additional settings

---

2. Select **Input** in the **Port 1** drop-down list.
3. Give the input module a descriptive name.
4. To make the PIR detector send a signal to the camera when it senses motion, select **Closed circuit** in the drop-down list.

To trigger the camera to start recording when it receives a signal from the PIR detector, you need to create an action rule in the camera's webpage.

### Use audio to deter intruders

This example explains how to connect a speaker to the camera and set it up to play a warning message when the camera detects motion in a restricted area.

#### Required hardware

- Active speaker with built-in amplifier and connecting wires

#### **NOTICE**

Make sure the camera is disconnected from power before making the connections. Reconnect to power after connecting the wires.

#### Physical connection

1. Connect the audio wire from the speaker to the **AUDIO OUT** pin on the camera. See *Product overview on page 3*.
2. Connect the grounding wire from the speaker to the **GND AUDIO OUT** pin on the camera. See *Product overview on page 3*.

#### Add audio clip to the camera

1. Go to **Settings > Audio > Output** and click  to add your audio clip.
2. Click **Add**.
3. Select **Upload** under **Add Audio Clip Options**.
4. Browse to locate the audio clip and click **Upload**.

To trigger the camera to play the audio clip when it detects motion, create an action rule in the camera's webpage.

### Direct the camera and open the lock to a gate when someone is nearby

This example explains how to direct the camera and open a gate when someone wants to enter during daytime. This is done by connecting a PIR detector to the product's input port and a switch relay to the product's output port.

#### Required hardware

- Mounted PIR detector
- Switch relay connected to the gate lock, in this case the switch is normally closed (NC)
- Connecting wires

#### Physical connection

1. Connect the wires from the PIR detector to the input pin, see *I/O connector on page 22*.
2. Connect the wires from the switch to the output pin, see *I/O connector on page 22*

# AXIS M5525-E PTZ Network Camera

## Additional settings

---

### Configure I/O ports

You need to connect the switch relay to the camera from the camera's webpage. First, configure the I/O ports:

#### Set the PIR detector to an input port

1. Go to **System > I/O ports**.

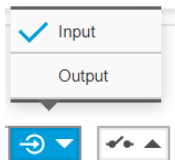

2. Select **Input** in the **Port 1** drop-down list.
3. Give the input module a descriptive name, for example "PIR detector".
4. To trigger an event whenever the PIR detector senses motion, select **Open circuit** in the drop-down list.

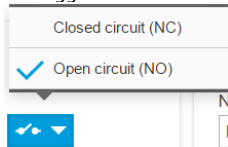

#### Set the switch relay to an output port

1. Go to **System > I/O ports**.

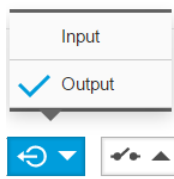

2. Select **Output** in the **Port 2** drop-down list.
3. Give the output module a descriptive name, for example "Gate switch".

4. To open the gate whenever an event is triggered, select **Closed circuit** in the drop-down list.

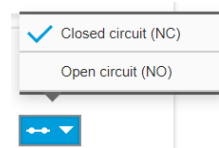

### Create rules

For the camera to open the gate when the PIR detector senses someone nearby, you need to create a rule in the camera:

1. Go to **System > Events > Action rules**.
2. Click **Add**.
3. Give the action rule a name, for example "Open gate".
4. In the **Trigger** drop-down menu, select **Input signal**.
5. Select **Digital input signal**.
6. Select "PIR detector", in this example connected to port 1.
7. Under **Actions**, select **Output port** from the **Type** drop-down menu.

# AXIS M5525-E PTZ Network Camera

## Additional settings

---

8. In the **Port** drop-down menu, select "Gate switch".
9. Click **Ok**.
10. Create another action rule with the name "Direct the camera to the gate".
11. Select the same input signal as before, but as action select the previously created "Gate entrance" preset position.
12. Click **Ok**.

## Applications

### Applications

With applications you can get more out of your Axis device. AXIS Camera Application Platform (ACAP) is an open platform that makes it possible for third parties to develop analytics and other applications for Axis devices. Applications can be preinstalled on the device, available for download for free, or for a license fee. To find out more about available applications, downloads, trials and licenses, go to [axis.com/products/acap/application-gallery](http://axis.com/products/acap/application-gallery).

To find the user manuals for Axis applications, go to [help.axis.com](http://help.axis.com).

#### Note

- Several applications can run at the same time but some applications might not be compatible with each other. Certain combinations of applications might require too much processing power or memory resources when run in parallel. Verify that the applications work together before deployment.



# AXIS M5525-E PTZ Network Camera

## Troubleshooting

---

### Troubleshooting

#### Reset to factory default settings

**Important**

Reset to factory default should be used with caution. A reset to factory default resets all settings, including the IP address, to the factory default values.

To reset the product to the factory default settings:

1. Disconnect power from the product.
2. Press and hold the control button while reconnecting power. See *Product overview on page 3*.
3. Keep the control button pressed for 15–30 seconds until the status LED indicator flashes amber.
4. Release the control button. The process is complete when the status LED indicator turns green. The product has been reset to the factory default settings. If no DHCP server is available on the network, the default IP address is 192.168.0.90.
5. Use the installation and management software tools to assign an IP address, set the password, and access the video stream.

The installation and management software tools are available from the support pages on [axis.com/support](https://axis.com/support).

It is also possible to reset parameters to factory default through the web interface. Go to **Settings > System > Maintenance** and click **Default**.

#### Check the current firmware

Firmware is the software that determines the functionality of network devices. One of your first actions when troubleshooting a problem should be to check the current firmware version. The latest version may contain a correction that fixes your particular problem.

To check the current firmware:

1. Go to the product's webpage.
2. Click the help menu  .
3. Click **About**.

#### Upgrade the firmware

**Important**

Preconfigured and customized settings are saved when the firmware is upgraded (provided that the features are available in the new firmware) although this is not guaranteed by Axis Communications AB.

**Important**

Make sure the product remains connected to the power source throughout the upgrade process.

**Note**

When you upgrade the product with the latest firmware in the active track, the product receives the latest functionality available. Always read the upgrade instructions and release notes available with each new release before upgrading the firmware. To find the latest firmware and the release notes, go to [axis.com/support/firmware](https://axis.com/support/firmware).

AXIS Device Manager can be used for multiple upgrades. Find out more at [axis.com/products/axis-device-manager](https://axis.com/products/axis-device-manager).

# AXIS M5525-E PTZ Network Camera

## Troubleshooting

---



To watch this video, go to the web version of this document.  
[help.axis.com/?&tid=37672&tsection=upgrade-the-firmware](http://help.axis.com/?&tid=37672&tsection=upgrade-the-firmware)

*How to upgrade the firmware*

1. Download the firmware file to your computer, available free of charge at [axis.com/support/firmware](http://axis.com/support/firmware).
2. Log in to the product as an administrator.
3. Go to **Settings > System > Maintenance**. Follow the instructions on the page. When the upgrade has finished, the product restarts automatically.

## Technical issues, clues and solutions

If you can't find what you're looking for here, try the troubleshooting section at [axis.com/support](http://axis.com/support).

### Problems upgrading the firmware

---

**Firmware upgrade failure** If the firmware upgrade fails, the device reloads the previous firmware. The most common reason is that the wrong firmware file has been uploaded. Check that the name of the firmware file corresponds to your device and try again.

### Problems setting the IP address

---

**The device is located on a different subnet** If the IP address intended for the device and the IP address of the computer used to access the device are located on different subnets, you cannot set the IP address. Contact your network administrator to obtain an IP address.

**The IP address is being used by another device** Disconnect the Axis device from the network. Run the ping command (in a Command/DOS window, type `ping` and the IP address of the device):

- If you receive: `Reply from <IP address>: bytes=32; time=10...` this means that the IP address may already be in use by another device on the network. Obtain a new IP address from the network administrator and reinstall the device.
- If you receive: `Request timed out`, this means that the IP address is available for use with the Axis device. Check all cabling and reinstall the device.

**Possible IP address conflict with another device on the same subnet** The static IP address in the Axis device is used before the DHCP server sets a dynamic address. This means that if the same default static IP address is also used by another device, there may be problems accessing the device.

### The device cannot be accessed from a browser

---

**Cannot log in** When HTTPS is enabled, ensure that the correct protocol (HTTP or HTTPS) is used when attempting to log in. You may need to manually type `http` or `https` in the browser's address field.

If the password for the user `root` is lost, the device must be reset to the factory default settings. See *Reset to factory default settings on page 17*.

# AXIS M5525-E PTZ Network Camera

## Troubleshooting

---

The IP address has been changed by DHCP	IP addresses obtained from a DHCP server are dynamic and may change. If the IP address has been changed, use AXIS IP Utility or AXIS Device Manager to locate the device on the network. Identify the device using its model or serial number, or by the DNS name (if the name has been configured).  If required, a static IP address can be assigned manually. For instructions, go to <a href="http://axis.com/support">axis.com/support</a> .
Certificate error when using IEEE 802.1X	For authentication to work properly, the date and time settings in the Axis device must be synchronized with an NTP server. Go to <b>Settings &gt; System &gt; Date and time</b> .

### The device is accessible locally but not externally

---

To access the device externally, we recommend using one of the following applications for Windows®:

- AXIS Companion: free of charge, ideal for small systems with basic surveillance needs.
- AXIS Camera Station: 30-day trial version free of charge, ideal for small to mid-size systems.

For instructions and download, go to [axis.com/vms](http://axis.com/vms).

### Problems with streaming

---

Multicast H.264 only accessible by local clients	Check if your router supports multicasting, or if the router settings between the client and the device need to be configured. The TTL (Time To Live) value may need to be increased.
No multicast H.264 displayed in the client	Check with your network administrator that the multicast addresses used by the Axis device are valid for your network.  Check with your network administrator to see if there is a firewall preventing viewing.
Poor rendering of H.264 images	Ensure that your graphics card is using the latest driver. The latest drivers can usually be downloaded from the manufacturer's website.
Color saturation is different in H.264 and Motion JPEG	Modify the settings for your graphics adapter. Go to the adapter's documentation for more information.
Lower frame rate than expected	<ul style="list-style-type: none"><li>• See <i>Performance considerations on page 19</i>.</li><li>• Reduce the number of applications running on the client computer.</li><li>• Limit the number of simultaneous viewers.</li><li>• Check with the network administrator that there is enough bandwidth available.</li><li>• Lower the image resolution.</li><li>• Log in to the device's webpage and set a capture mode that prioritizes frame rate. Changing the capture mode to prioritize frame rate might lower the maximum resolution depending on the device used and capture modes available.</li></ul>

## Performance considerations

When setting up your system, it is important to consider how various settings and situations affect the performance. Some factors affect the amount of bandwidth (the bitrate) required, others can affect the frame rate, and some affect both. If the load on the CPU reaches its maximum, this also affects the frame rate.

The following factors are the most important to consider:

- High image resolution or lower compression levels result in images containing more data which in turn affects the bandwidth.
- Rotating the image in the GUI can increase the product's CPU load.
- Access by large numbers of Motion JPEG or unicast H.264 clients affects the bandwidth.
- Simultaneous viewing of different streams (resolution, compression) by different clients affects both frame rate and bandwidth.

Use identical streams wherever possible to maintain a high frame rate. Stream profiles can be used to ensure that streams are identical.

# AXIS M5525-E PTZ Network Camera

## Troubleshooting

---

- Accessing Motion JPEG and H.264 video streams simultaneously affects both frame rate and bandwidth.
- Heavy usage of event settings affects the product's CPU load which in turn affects the frame rate.
- Using HTTPS may reduce frame rate, in particular if streaming Motion JPEG.
- Heavy network utilization due to poor infrastructure affects the bandwidth.
- Viewing on poorly performing client computers lowers perceived performance and affects frame rate.
- Running multiple AXIS Camera Application Platform (ACAP) applications simultaneously may affect the frame rate and the general performance.

# AXIS M5525-E PTZ Network Camera

## Specifications

---

### Specifications

#### LED indicators

Status LED	Indication
Unlit	Connection and normal operation.
Green	Shows steady green for 10 seconds for normal operation after startup completed.
Amber	Steady during startup. Flashes during firmware upgrade or reset to factory default.
Amber/Red	Flashes amber/red if network connection is unavailable or lost.

#### SD card slot

##### **NOTICE**

- Risk of damage to SD card. Don't use sharp tools, metal objects, or excessive force when inserting or removing the SD card. Use your fingers to insert and remove the card.
- Risk of data loss and corrupted recordings. Unmount the SD card from the device's web interface before removing it. Don't remove the SD card while the product is running.

This device supports microSD/microSDHC/microSDXC cards.

For SD card recommendations, see [axis.com](http://axis.com).



microSD, microSDHC, and microSDXC Logos are trademarks of SD-3C LLC. microSD, microSDHC, microSDXC are trademarks or registered trademarks of SD-3C, LLC in the United States, other countries or both.

#### Buttons

##### Control button

The control button is used for:

- Resetting the product to factory default settings. See *Reset to factory default settings on page 17*.

#### Connectors

##### Network connector

RJ45 Ethernet connector with Power over Ethernet (PoE).

##### Audio connector

4-pin terminal block for audio input and output. See *Product overview on page 3*.

For audio in, the left channel is used from a stereo signal.

Pin	Notes
AUDIO IN	Microphone or line in (mono)
GND AUDIO IN	Ground audio in

# AXIS M5525-E PTZ Network Camera

## Specifications

AUDIO OUT	Line audio out
GND AUDIO OUT	Ground audio out

### I/O connector

Use the I/O connector with external devices in combination with, for example, motion detection, event triggering, and alarm notifications. In addition to the 0 V DC reference point and power (12 V DC output), the I/O connector provides the interface to:

**Digital input** – For connecting devices that can toggle between an open and closed circuit, for example PIR sensors, door/window contacts, and glass break detectors.

**Digital output** – For connecting external devices such as relays and LEDs. Connected devices can be activated by the VAPIX® Application Programming Interface, through an event or from the device's web interface.

6-pin terminal block. See *Product overview on page 3*.

Function	Pin	Notes	Specifications
0 V DC (-)	GND	DC ground	0 V DC
DC output	12 V	Can be used to power auxiliary equipment. Note: This pin can only be used as power out.	12 V DC Max load = 50 mA
Configurable (Input or Output)	I/O 1-4	Digital input – Connect to pin GND to activate, or leave floating (unconnected) to deactivate.	0 to max 30 V DC
		Digital output – Internally connected to pin 1 (DC ground) when active, and floating (unconnected) when inactive. If used with an inductive load, e.g. a relay, a diode must be connected in parallel with the load, for protection against voltage transients.	0 to max 30 V DC, open drain, 100 mA

### Power connector

2-pin terminal block for DC power input. Use a Safety Extra Low Voltage (SELV) compliant limited power source (LPS) with either a rated output power limited to  $\leq 100$  W or a rated output current limited to  $\leq 5$  A.

