

AXIS M7116 Video Encoder

Table of Contents

Get started..... 4

- Find the device on the network..... 4
 - Browser support..... 4
- Open the device's web interface..... 4
- Create an administrator account..... 4
- Secure passwords..... 5
- Make sure that no one has tampered with the device software 5
- Web interface overview 5

Configure your device..... 6

- Set video input..... 6
- Adjust the image..... 6
 - Level the camera 6
 - Monitor long and narrow areas..... 6
 - Hide parts of the image with privacy masks..... 6
 - Show an image overlay 7
 - Show a text overlay..... 7
- Adjust the camera view (PTZ)..... 7
 - Select a PTZ driver 7
 - Create a guard tour with preset positions..... 7
- View and record video 8
 - Reduce bandwidth and storage 8
 - Set up network storage 8
 - Record and watch video 9
- Set up rules for events 9
 - Trigger an action 9
 - Record video when the camera detects an object..... 9
 - Trigger a notification when the camera lens is tampered 10

The web interface 11

Learn more..... 12

- Privacy masks 12
- Overlays 12
- Pan, tilt, and zoom (PTZ) 12
 - Guard tours..... 12
- Streaming and storage..... 12
 - Video compression formats..... 12
 - How do Image, Stream, and Stream profile settings relate to each other?..... 13
- Analytics and apps 13

Troubleshooting..... 14

- Reset to factory default settings 14
- AXIS OS options..... 14
 - Check the current AXIS OS version 14
 - Upgrade AXIS OS..... 14
- Technical problems and possible solutions 15
- Performance considerations 17
- Contact support 18

Specifications..... 19

- Product overview 19
 - 19
- LED indicators..... 19
- SD card slot..... 19
- Buttons..... 20
 - Control button 20
- Connectors..... 20

Bus connector	20
BNC connector	20
Network connector	20
Power connector	20
RS485/RS422 connector.....	20
PTZ drivers	22
American Dynamics.....	22
Bosch.....	22
Canon	22
Cohu.....	22
Daiwa	23
Dennard	24
Elmo	25
Eneo	26
Ernitec.....	27
Fieldeye.....	28
Forwardvision	29
Geutebrück.....	30
JVC.....	30
Kalatel	31
Kalatel Digiplex.....	32
KDec300	32
Lilin	32
OpenEye.....	33
Panasonic.....	34
Pelco	35
Philips.....	36
Samsung	38
Sensormatic.....	39
Siemens	40
Smartscan	41
Teb	41
Ultrak	42
VCC	44
VCL.....	44
Vicon	45
Videmech	46
Videotec.....	48
Videotec Macro.....	48
Visca.....	49
Cybersecurity	51
Vulnerability management	51
Security notifications.....	51
Secure product lifecycle.....	51

Get started

Find the device on the network

To find Axis devices on the network and assign them IP addresses in Windows®, use AXIS IP Utility or AXIS Device Manager. Both applications are free and can be downloaded from axis.com/support.

For more information about how to find and assign IP addresses, go to *How to assign an IP address and access your device*.

Browser support

You can use the device with the following browsers:

	Chrome™	Edge™	Firefox®	Safari®
Windows®	✓	✓	*	*
macOS®	✓	✓	*	*
Linux®	✓	✓	*	*
Other operating systems	*	*	*	*

✓: Recommended

*: Supported with limitations

Open the device's web interface

1. Open a browser and type the IP address or host name of the Axis device.
If you don't know the IP address, use AXIS IP Utility or AXIS Device Manager to find the device on the network.
2. Type the username and password. If you access the device for the first time, you must create an administrator account. See *Create an administrator account, on page 4*.

For descriptions of all features and settings in the web interface of devices with AXIS OS, see *AXIS OS web interface help*.

Create an administrator account

The first time you log in to your device, you must create an administrator account.

1. Enter a username.
2. Enter a password. See *Secure passwords, on page 5*.
3. Re-enter the password.
4. Accept the license agreement.
5. Click **Add account**.

Important

The device has no default account. If you lose the password for your administrator account, you must reset the device. See *Reset to factory default settings, on page 14*.

Secure passwords

Important

Use HTTPS (which is enabled by default) to set your password or other sensitive configurations over the network. HTTPS enables secure and encrypted network connections, thereby protecting sensitive data, such as passwords.

The device password is the primary protection for your data and services. Axis devices do not impose a password policy as they may be used in various types of installations.

To protect your data we strongly recommend that you:

- Use a password with at least 8 characters, preferably created by a password generator.
- Don't expose the password.
- Change the password at a recurring interval, at least once a year.

Make sure that no one has tampered with the device software

To make sure that the device has its original AXIS OS, or to take full control of the device after a security attack:

1. Reset to factory default settings. See *Reset to factory default settings, on page 14*.
After the reset, secure boot guarantees the state of the device.
2. Configure and install the device.

Web interface overview

This video gives you an overview of the device's web interface.



Axis device web interface

Configure your device

Set video input

To use the video encoder, you must set the video inputs for the connected cameras (channels). When you log in to your device for the first time, the automatically detected video inputs for the cameras are set to **Automatic**.

To change the video inputs:



1. Go to **System > Video input**.
2. Select **Manual** and select the video standard and resolution for each channel you want to change.
3. Click **Save changes & restart**.

Adjust the image

This section includes instructions about configuring your device. If you want to learn more about how certain features work, go to *Learn more, on page 12*.

Level the camera

To adjust the view in relation to a reference area or an object, use the level grid in combination with a mechanical adjustment of the camera.

1. Go to **Video > Image >** and click .
2. Click  to show the level grid.
3. Adjust the camera mechanically until the position of the reference area or the object is aligned with the level grid.

Monitor long and narrow areas

Use corridor format to better utilize the full field of view in a long and narrow area, for example a staircase, hallway, road, or tunnel.

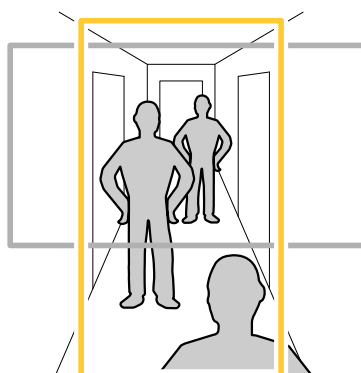

1. Depending on your device, turn the camera or the 3-axis lens in the camera 90° or 270°.
2. If the device doesn't have automatic rotation of the view, go to **Video > Installation**.
3. Rotate the view 90° or 270°.

Hide parts of the image with privacy masks

You can create one or several privacy masks to hide parts of the image.

1. Go to **Video > Privacy masks**.
2. Click .

3. Click the new mask and type a name.
4. Adjust the size and placement of the privacy mask according to your needs.
5. To change the color for all privacy masks, click **Privacy masks** and select a color.

See also *Privacy masks, on page 12*

Show an image overlay

You can add an image as an overlay in the video stream.

1. Go to **Video > Overlays**.
2. Click **Manage images**.
3. Upload or drag and drop an image.
4. Click **Upload**.
5. Select **Image** from the drop-down list and click **+**.
6. Select the image and a position. You can also drag the overlay image in the live view to change the position.

Show a text overlay

You can add a text field as an overlay in the video stream. This is useful for example when you want to display the date, time or a company name in the video stream.

1. Go to **Video > Overlays**.
2. Select **Text** and click **+**.
3. Type the text you want to display, or select modifiers to show for example the current date.
4. Select a position. You can also click-and-drag the overlay in the live view to change the position.

Adjust the camera view (PTZ)

Select a PTZ driver

1. Go to **System > Accessories > PTZ**.
2. Select the **Driver** from the drop-down list.
3. Select the **Device type** and type the **Device id**. The device type and device id are driver dependent.
4. Go to the **PTZ** tab and check that the PTZ settings are available.

For more information about PTZ drivers and supported device types, see *PTZ drivers, on page 22*.

Create a guard tour with preset positions

A guard tour displays the video stream from different preset positions either in a predetermined or random order, and for configurable periods of time.

1. Go to **PTZ > Guard tours**.
2. Click **+** **Guard tour**.
3. Select **Preset position** and click **Create**.
4. Under **General settings**:
 - Enter a name for the guard tour and specify the pause length between each tour.

- If you want the guard tour to go to the preset positions in a random order, turn on **Play guard tour in random order**.
5. Under **Step settings**:
 - Set the duration for the preset.
 - Set the move speed, which controls how fast to move to the next preset.
 6. Go to **Preset positions**.
 - 6.1. Select the preset positions that you want in your guard tour.
 - 6.2. Drag them to the **View order** area, and click **Done**.
 7. To schedule the guard tour, go to **System > Events**.

View and record video

This section includes instructions about configuring your device. To learn more about how streaming and storage works, go to *Streaming and storage, on page 12*.

Reduce bandwidth and storage

Important

Reducing the bandwidth can lead to loss of detail in the image.

1. Go to **Video > Stream**.
2. Click  in the live view.
3. Select **Video format AV1** if your device supports it. Otherwise select **H.264**.
4. Go to **Video > Stream > General** and increase **Compression**.
5. Go to **Video > Stream > Zipstream** and do one or more of the following:

Note

The **Zipstream** settings are used for all video encodings except MJPEG.

- Select the **Zipstream Strength** that you want to use.
- Turn on **Optimize for storage**. This can only be used if the video management software supports B-frames.
- Turn on **Dynamic FPS**.
- Turn on **Dynamic GOP** and set a high **Upper limit GOP length** value.

Note

Most web browsers don't support H.265 decoding and because of this the device doesn't support it in its web interface. Instead you can use a video management system or application that supports H.265 decoding.

Set up network storage

To store recordings on the network, you need to set up your network storage.

1. Go to **System > Storage**.
2. Click  **Add network storage** under **Network storage**.
3. Type the IP address of the host server.
4. Type the name of the shared location on the host server under **Network share**.
5. Type the username and password.
6. Select the SMB version or leave it on **Auto**.
7. Select **Add share without testing** if you experience temporary connection issues, or if the share is not yet configured.

8. Click **Add**.

Record and watch video

Record video directly from the camera

1. Go to **Video > Stream**.
2. To start a recording, click .

If you haven't set up any storage, click  and . For instructions on how to set up network storage, see *Set up network storage, on page 8*

3. To stop recording, click  again.

Watch video

1. Go to **Recordings**.
2. Click  for your recording in the list.

Set up rules for events

You can create rules to make your device perform an action when certain events occur. A rule consists of conditions and actions. The conditions can be used to trigger the actions. For example, the device can start a recording or send an email when it detects motion, or show an overlay text while the device is recording.

To learn more, see *Get started with rules for events*.

Trigger an action

1. Go to **System > Events** and add a rule. The rule defines when the device will perform certain actions. You can set up rules as scheduled, recurring, or manually triggered.
2. Enter a **Name**.
3. Select the **Condition** that must be met to trigger the action. If you specify more than one condition for the rule, all of the conditions must be met to trigger the action.
4. Select which **Action** to perform when the conditions are met.

Record video when the camera detects an object

This example explains how to set up the camera to start recording to the SD card when the camera detects an object. The recording will include five seconds before detection and one minute after detection ends.

Before you start:

- Make sure you have an SD card installed.

Make sure that **AXIS Video Motion Detection** is running:

1. Go to **Apps > AXIS Video Motion Detection**.
2. Start the application if it is not already running.
3. Make sure you have set up the application according to your needs.

Create a rule:

1. Go to **System > Events** and add a rule.
2. Type a name for the rule.
3. In the list of conditions, under **Application**, select **VMD4**.
4. In the list of actions, under **Recordings**, select **Record video while the rule is active**.
5. In the list of storage options, select **SD_DISK**.

6. Select a camera and a stream profile.
7. Set the prebuffer time to 5 seconds.
8. Set the postbuffer time to 1 minute.
9. Click **Save**.

Trigger a notification when the camera lens is tampered

This example explains how to set up an email notification when the camera lens gets either spray painted, covered, or blurred.

Activate the tampering detection:

1. Go to **System > Detectors > Camera tampering**.
2. Set a value for **Trigger delay**. The value indicates the time that must pass before an email is sent.
3. Turn on **Trigger on dark images** to detect if the lens is sprayed, covered, or rendered severely out of focus.

Add an email recipient:

4. Go to **System > Events > Recipients** and add a recipient.
5. Type a name for the recipient.
6. Select **Email** as the notification type.
7. Type the recipient's email address.
8. Type the email address that you want the camera to send notifications from.
9. Provide the login details for the sending email account, along with the SMTP hostname and port number.
10. To test your email setup, click **Test**.
11. Click **Save**.

Create a rule:

12. Go to **System > Events > Rules** and add a rule.
13. Type a name for the rule.
14. In the list of conditions, under **Video**, select **Tampering**.
15. In the list of actions, under **Notifications**, select **Send notification to email** and then select the recipient from the list.
16. Type a subject line and message for the email.
17. Click **Save**.

The web interface

To read about all the features and settings available in the web interface of devices with AXIS OS, go to *AXIS OS web interface help*.

Learn more

Privacy masks

A privacy mask is a user-defined area that covers a part of the monitored area. In the video stream, privacy masks appear either as blocks of solid color or with a mosaic pattern.

You'll see the privacy mask on all snapshots, recorded video, and live streams.

You can use the VAPIX® application programming interface (API) to hide the privacy masks.

Important

If you use multiple privacy masks it may affect the product's performance.

You can create several privacy masks. Each mask can have 3 to 10 anchor points.

Overlays

Overlays are superimposed over the video stream. They are used to provide extra information during recordings, such as a timestamp, or during product installation and configuration. You can add either text or an image.

Pan, tilt, and zoom (PTZ)

Guard tours

A guard tour displays the video stream from different preset positions either in a predetermined or random order, and for configurable periods of time. Once started, a guard tour continues to run until stopped, even when there are no clients (web browsers) viewing the images.

Note

The pause between successive guard tours is at least 10 minutes, and the fixed minimum viewing time is 10 seconds.

Streaming and storage

Video compression formats

Decide which compression method to use based on your viewing requirements, and on the properties of your network. The available options are:

Motion JPEG

Motion JPEG, or MJPEG, is a digital video sequence that is made up of a series of individual JPEG images. These images are then displayed and updated at a rate sufficient to create a stream that shows constantly updated motion. For the viewer to perceive motion video the rate must be at least 16 image frames per second. Full motion video is perceived at 30 (NTSC) or 25 (PAL) frames per second.

The Motion JPEG stream uses considerable amounts of bandwidth, but provides excellent image quality and access to every image contained in the stream.

H.264 or MPEG-4 Part 10/AVC

Note

H.264 is a licensed technology. The Axis product includes one H.264 viewing client license. To install additional unlicensed copies of the client is prohibited. To purchase additional licenses, contact your Axis reseller.

H.264 can, without compromising image quality, reduce the size of a digital video file by more than 80% compared to the Motion JPEG format and by as much as 50% compared to older MPEG formats. This means that less network bandwidth and storage space are required for a video file. Or seen another way, higher video quality can be achieved for a given bitrate.

H.265 or MPEG-H Part 2/HEVC

H.265 can, without compromising image quality, reduce the size of a digital video file by more than 25% compared to H.264.

Note

- H.265 is licensed technology. The Axis product includes one H.265 viewing client license. Installing additional unlicensed copies of the client is prohibited. To purchase additional licenses, contact your Axis reseller.
- Most web browsers don't support H.265 decoding and because of this the camera doesn't support it in its web interface. Instead you can use a video management system or application supporting H.265 decoding.

How do Image, Stream, and Stream profile settings relate to each other?

The **Image** tab contains camera settings that affect all video streams from the product. If you change something in this tab, it immediately affects all video streams and recordings.

The **Stream** tab contains settings for video streams. You get these settings if you request a video stream from the product and don't specify for example resolution, or frame rate. When you change the settings in the **Stream** tab, it doesn't affect ongoing streams, but it will take effect when you start a new stream.

The **Stream profiles** settings override the settings from the **Stream** tab. If you request a stream with a specific stream profile, the stream contains the settings of that profile. If you request a stream without specifying a stream profile, or request a stream profile that doesn't exist in the product, the stream contains the settings from the **Stream** tab.

Analytics and apps

With analytics and apps you can get more out of your Axis device. AXIS Camera Application Platform (ACAP) is an open platform that makes it possible for third parties to develop analytics and other apps for Axis devices. Apps can be preinstalled on the device, available for download for free, or for a license fee.

To find the user manuals for Axis analytics and apps, go to help.axis.com.

Troubleshooting

Reset to factory default settings

Important

Reset to factory default should be used with caution. A reset to factory default resets all settings, including the IP address, to the factory default values.

To reset the product to the factory default settings:

1. Disconnect power from the product.
2. Press and hold the control button while reconnecting power. See *Product overview, on page 19*.
3. Keep the control button pressed for 15–30 seconds until the status LED indicator flashes amber.
4. Release the control button. The process is complete when the status LED indicator turns green. If no DHCP server is available on the network, the device IP address will default to one of the following:
 - **Devices with AXIS OS 12.0 and later:** Obtained from the link-local address subnet (169.254.0.0/16)
 - **Devices with AXIS OS 11.11 and earlier:** 192.168.0.90/24
5. Use the installation and management software tools to assign an IP address, set the password, and access the device.
The installation and management software tools are available from the support pages on axis.com/support.

You can also reset parameters to factory default through the device's web interface. Go to **Maintenance > Factory default** and click **Default**.

AXIS OS options

Axis offers device software management according to either the active track or the long-term support (LTS) tracks. Being on the active track means continuously getting access to all the latest product features, while the LTS tracks provide a fixed platform with periodic releases focused mainly on bug fixes and security updates.

Using AXIS OS from the active track is recommended if you want to access the newest features, or if you use Axis end-to-end system offerings. The LTS tracks are recommended if you use third-party integrations, which are not continuously validated against the latest active track. With LTS, the products can maintain cybersecurity without introducing any significant functional changes or affecting any existing integrations. For more detailed information about Axis device software strategy, go to axis.com/support/device-software.

Check the current AXIS OS version

AXIS OS determines the functionality of our devices. When you troubleshoot a problem, we recommend that you to start by checking the current AXIS OS version. The latest version might contain a correction that fixes your particular problem.

To check the current AXIS OS version:

1. Go to the device's web interface > **Status**.
2. Under **Device info**, see the AXIS OS version.

Upgrade AXIS OS

Important

- When you upgrade the device software, your preconfigured and customized settings are saved. Axis Communications AB can't guarantee that the settings are saved, even if the features are available in the new AXIS OS version.
- Starting from AXIS OS 12.6, you must install every LTS version between your device's current version and the target version. For example, if the currently installed device software version is AXIS OS 11.2, you

have to install the LTS version AXIS OS 11.11 before you can upgrade the device to AXIS OS 12.6. For more information, see *AXIS OS Lifecycle guide: Upgrade path*.

- Make sure the device remains connected to the power source throughout the upgrade process.

Note

- When you upgrade the device with the latest AXIS OS version in the active track, the product receives the latest functionality available. Always read the upgrade instructions and release notes available with each new release before you upgrade. To find the latest AXIS OS version and the release notes, go to axis.com/support/device-software.
1. Download the AXIS OS file to your computer, available free of charge at axis.com/support/device-software.
 2. Log in to the device as an administrator.
 3. Go to **Maintenance > AXIS OS upgrade** and click **Upgrade**.

When the upgrade has finished, the product restarts automatically.

You can use AXIS Device Manager to upgrade multiple devices at the same time. Find out more at axis.com/products/axis-device-manager.

Technical problems and possible solutions

Problems upgrading AXIS OS

AXIS OS upgrade failed

If the upgrade fails, the device reloads the previous version. The most common reason is that the wrong AXIS OS file has been uploaded. Check that the name of the AXIS OS file corresponds to your device and try again.

Problems after AXIS OS upgrade

If you experience problems after the upgrade, roll back to the previously installed version from the **Maintenance** page.

Problems setting the IP address

Can't set the IP address

- If the IP address intended for the device and the IP address of the computer used to access the device are located on different subnets, you can't set the IP address. Contact your network administrator to obtain an IP address.
- The IP address could be in use by another device. To check:
 1. Disconnect the Axis device from the network.
 2. In a Command/DOS window, type `ping` and the IP address of the device.
 3. If you receive: `Reply from <IP address>: bytes=32; time=10...` this means that the IP address might already be in use by another device on the network. Obtain a new IP address from the network administrator and reinstall the device.
 4. If you receive: `Request timed out`, this means that the IP address is available for use with the Axis device. Check all cabling and reinstall the device.
- There could be a possible IP address conflict with another device on the same subnet. The static IP address in the Axis device is used before the DHCP server sets a dynamic address. This means that if the same default static IP address is also used by another device, there could be problems accessing the device.

Problems accessing the device

Can't log in when accessing the device from a browser

When HTTPS is enabled, make sure that you use the correct protocol (HTTP or HTTPS) when you try to log in. You might need to manually type `http` or `https` in the browser's address field.

If you've lost the password for the root account, you must reset the device to the factory default settings. For instructions, see *Reset to factory default settings, on page 14*.

The IP address has been changed by DHCP

IP addresses obtained from a DHCP server are dynamic and could change. If the IP address has been changed, use AXIS IP Utility or AXIS Device Manager to locate the device on the network. Identify the device using its model or serial number, or by the DNS name (if the name has been configured).

If required, you can assign a static IP address manually. For instructions, go to axis.com/support.

Certificate error when using IEEE 802.1X

For authentication to work properly, the date and time settings in the Axis device must be synchronized with an NTP server. Go to **System > Date and time**.

The browser isn't supported

For a list of recommended browsers, see *Browser support, on page 4*.

Can't access the device externally

To access the device externally, we recommend you to use one of the following applications for Windows®:

- AXIS Camera Station Edge: free of charge, ideal for small systems with basic surveillance needs.
- AXIS Camera Station Pro: 90-day trial version free of charge, ideal for small to mid-size systems.

For instructions and download, go to axis.com/vms.

Problems with streaming

Multicast H.264 only accessible by local clients

Check if your router supports multicasting, or if you need to configure the router settings between the client and the device. You might need to increase the TTL (Time To Live) value.

No multicast H.264 displayed in the client

Check with your network administrator that the multicast addresses used by the Axis device are valid for your network.

Check with your network administrator to see if there is a firewall that prevents viewing.

Poor rendering of H.264 images

Ensure that your graphics card uses the latest driver. You can usually download the latest drivers from the manufacturer's website.

Color saturation is different in H.264 and Motion JPEG

Modify the settings for your graphics adapter. Check the adapter's documentation for more information.

Lower frame rate than expected

- See *Performance considerations, on page 17*.
- Reduce the number of applications running on the client computer.
- Limit the number of simultaneous viewers.
- Check with the network administrator that there is enough bandwidth available.
- Lower the image resolution.

Can't select H.265 encoding in live view

Web browsers don't support H.265 decoding. Use a video management system or application that supports H.265 decoding.

Problems with MQTT

Can't connect over port 8883 with MQTT over SSL

The firewall blocks traffic that uses port 8883 since it's regarded insecure.

In some cases the server/broker might not provide a specific port for MQTT communication. It might still be possible to use MQTT over a port normally used for HTTP/HTTPS traffic.

- If the server/broker supports WebSocket/WebSocket Secure (WS/WSS), typically on port 443, use this protocol instead. Check with the server/broker provider to see if WS/WSS is supported and which port and basepath to use.
- If the server/broker supports ALPN, the use of MQTT can be negotiated over an open port, such as 443. Check with your server/broker provider to see if ALPN is supported and which ALPN protocol and port to use.

Problems with operating the device

Front heater and wiper aren't working

If the front heater or wiper are not turning on, confirm that the top cover is properly fastened to the bottom of the housing unit.

If you can't find what you're looking for here, try the troubleshooting section at axis.com/support.

Performance considerations

The most important factors to consider:

- High image resolution or lower compression levels result in images containing more data which in turn affects the bandwidth.
- Access by large numbers of Motion JPEG clients or unicast H.264/H.265/AV1 clients affects the bandwidth.
- Simultaneous viewing of different streams (resolution, compression) by different clients affects both frame rate and bandwidth. Use identical streams wherever possible to maintain a high frame rate. Stream profiles can be used to ensure that streams are identical.
- Accessing video streams with different codecs simultaneously affects both frame rate and bandwidth. For optimal performance, use streams with the same codec.
- Heavy usage of event settings affects the product's CPU load which in turn affects the frame rate.

- Using HTTPS may reduce frame rate, in particular if streaming Motion JPEG.
- Heavy network utilization due to poor infrastructure affects the bandwidth.
- Viewing on poorly performing client computers lowers perceived performance and affects frame rate.

Contact support

If you need more help, go to axis.com/support.

Specifications

Product overview

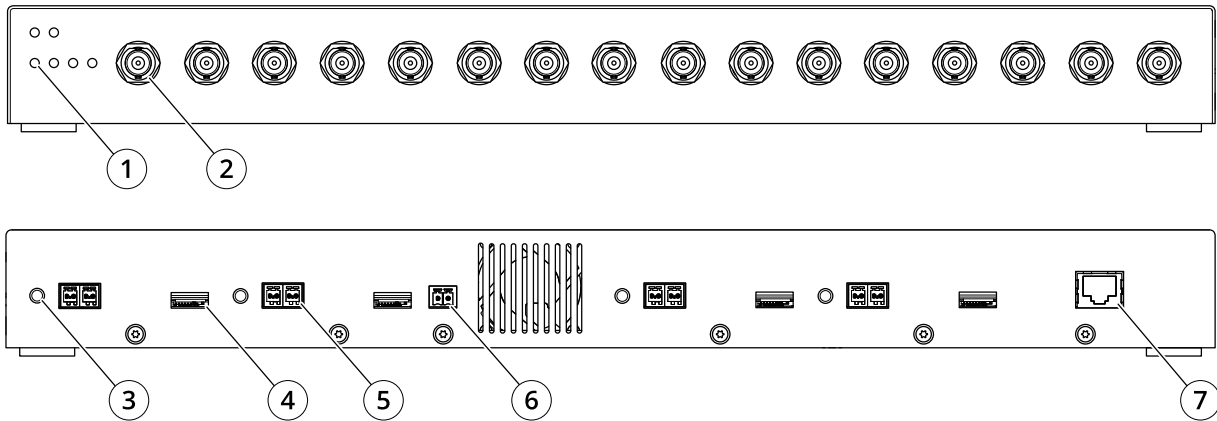

- 1 4x Status LED
- 2 16x BNC connectors
- 3 4x Control button
- 4 4x MicroSD card slot
- 5 4x RS485/RS422 connector
- 6 Power connector
- 7 Ethernet RJ45

LED indicators

Status LED	Indication
Unlit	Connection and normal operation.
Green	Steady green for normal operation.
Amber	Steady during startup, during reset to factory default or when restoring settings.

Network LED	Indication
Green	Steady for connection to a 1 Gbit/s network. Flashes for network activity.
Amber	Steady for connection to a 10/100 Mbit/s network. Flashes for network activity.
Unlit	No network connection.

SD card slot

NOTICE

- Risk of damage to SD card. Don't use sharp tools, metal objects, or excessive force when inserting or removing the SD card. Use your fingers to insert and remove the card.
- Risk of data loss and corrupted recordings. Unmount the SD card from the device's web interface before removing it. Don't remove the SD card while the product is running.

This device supports microSD/microSDHC/microSDXC cards.

For SD card recommendations, see axis.com.

 microSD, microSDHC, and microSDXC Logos are trademarks of SD-3C LLC. microSD, microSDHC, microSDXC are trademarks or registered trademarks of SD-3C, LLC in the United States, other countries or both.

Buttons

Control button

The control button is used for:

- Resetting the product to factory default settings. See *Reset to factory default settings, on page 14*.

Connectors

Bus connector

The bus connectors are the physical interfaces to the video encoder chassis that provide power, network, RS485, and I/O terminal connections.

BNC connector

Each video input is terminated using a coax/BNC connector.

Connect a 75 Ohm coaxial video cable; the recommended maximum length is 250 m (800 ft).

Note

75 Ohm video termination can be enabled or disabled for the video input through the device's web interface at . Video termination is enabled on factory default. If the product is connected in parallel with other equipment, for optimum video quality, we recommended to enable video termination only for the last device in the video signal chain.

Network connector

RJ45 Ethernet connector.

Power connector

2-pin terminal block for DC power input. Use a Safety Extra Low Voltage (SELV) compliant limited power source (LPS) with either a rated output power limited to ≤ 100 W or a rated output current limited to ≤ 5 A.

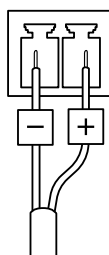

RS485/RS422 connector

Two 2-pin terminal blocks for RS485/RS422 serial interface. The serial port can be configured to support:

- Two-wire RS485 half duplex
- Four-wire RS485 full duplex
- Two-wire RS422 simplex
- Four-wire RS422 full duplex point to point communication

RS485/422

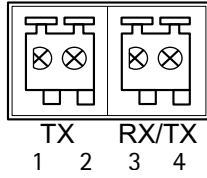

Function	Pin	Notes
RS485/RS422 TX A	1	(TX) For full duplex RS485/RS422
RS485/RS422 TX B	2	
RS485/RS422 RX/TX A	3	(RX) For full duplex RS485/RS422 (RX/TX) For half duplex RS485
RS485/RS422 RX/TX B	4	

PTZ drivers

American Dynamics

For more details, go to *Sensormatic*, on page 39.

Bosch

For more details, go to *Philips*, on page 36.

Canon

For more details, go to *VCC*, on page 44.

Cohu

This is a list of models supported by this driver. The physical installation depends on the video encoder and the PTZ unit.

Important

Check what serial communication the video encoder and PTZ unit will support.

Supported models:

- Cohu 3950 iVIEW
- Cohu ER8945
- Cohu ER8945A

Other models may be supported but this has not been verified by Axis.

Technical information

DEFAULT capabilities for PTZ driver:

Driver	Cohu
Version	4.12

DEFAULT serial configuration:

PortMode	RS422
BaudRate	9,600
DataBits	8
StopBits	1
Parity	None

DEFAULT supported capabilities in this PTZ driver:

Note

Different PTZ models may have other capabilities (both less and more).

Movement	Absolute	Relative	Continuous
Pan	yes	yes	yes
Tilt	yes	yes	yes
Zoom	yes	yes	yes

PortMode	RS485
BaudRate	9,600
DataBits	8
StopBits	1
Parity	None

DEFAULT supported capabilities in this PTZ driver:

Note

Different PTZ models may have other capabilities (both less and more).

Movement	Absolute	Relative	Continuous
Pan	yes	yes	yes
Tilt	yes	yes	yes
Zoom	yes	yes	yes
Focus	no	yes	yes
Iris	no	no	no

Autolris	no
AutoFocus	yes
IrCutFilter	no
BackLight	no
OSDMenu	yes

Connection example

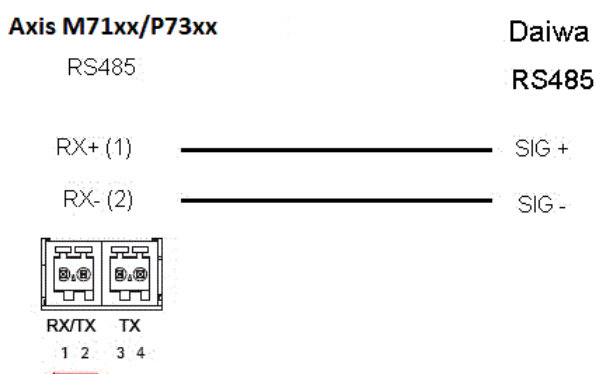

Dennard

This is a list of models supported by this driver. The physical installation depends on the video encoder and the PTZ unit.

Important

Check what serial communication the video encoder and PTZ unit will support.

Supported models:

- Dennard 2050
- Dennard 2060

Other models may be supported but this has not been verified by Axis.

Elmo

This is a list of models supported by this driver. The physical installation depends on the video encoder and the PTZ unit.

Important

Check what serial communication the video encoder and PTZ unit will support.

Supported models:

- Elmo PTC-400C
- Elmo PTC-1000

Other models may be supported but this has not been verified by Axis.

Technical information

DEFAULT capabilities for PTZ driver:

Driver	Elmo
Version	4.00

DEFAULT serial configuration:

PortMode	RS485
BaudRate	9,600
DataBits	8
StopBits	1
Parity	None

DEFAULT supported capabilities in this PTZ driver:

Note

Different PTZ models may have other capabilities (both less and more).

Movement	Absolute	Relative	Continuous
Pan	yes	yes	yes
Tilt	yes	yes	yes
Zoom	yes	yes	yes
Focus	no	yes	yes
Iris	no	yes	yes

Autolris	yes
AutoFocus	yes
IrCutFilter	no

BackLight	no
OSDMenu	yes

Eneo

This is a list of models supported by this driver. The physical installation depends on the video encoder and the PTZ unit.

Important

Check what serial communication the video encoder and PTZ unit will support.

Supported models:

- EDC-141E
- EDC-142E
- EDC-143E
- EDC-144E

Other models may be supported but this has not been verified by Axis.

Technical information

DEFAULT capabilities for PTZ driver:

Driver	Eneo-F2
Version	4.03

DEFAULT serial configuration:

PortMode	RS485
BaudRate	9,600
DataBits	8
StopBits	1
Parity	None

DEFAULT supported capabilities in this PTZ driver:

Note

Different PTZ models may have other capabilities (both less and more).

Movement	Absolute	Relative	Continuous
Pan	no	yes	yes
Tilt	no	yes	yes
Zoom	no	yes	yes
Focus	no	yes	yes
Iris	no	yes	yes

AutoIris	no
AutoFocus	no

IrCutFilter	no
BackLight	no
OSDMenu	no

Ernitec

This is a list of models supported by this driver. The physical installation depends on the video encoder and the PTZ unit.

Important

Check what serial communication the video encoder and PTZ unit will support.

Supported models:

- Ernitec ICU-PTZ-S 51PA
- Ernitec Orion 361-23C
- Ernitec Orion/3-DN

Other models may be supported but this has not been verified by Axis.

Technical information

DEFAULT capabilities for PTZ driver:

Driver	Ernitec
Version	4.02

DEFAULT serial configuration:

PortMode	RS485
BaudRate	2,400
DataBits	8
StopBits	1
Parity	None

DEFAULT supported capabilities in this PTZ driver:

Note

Different PTZ models may have other capabilities (both less and more).

Movement	Absolute	Relative	Continuous
Pan	no	yes	yes
Tilt	no	yes	yes
Zoom	no	yes	yes
Focus	no	yes	yes
Iris	no	yes	yes

AutoIris	yes
AutoFocus	yes

IrCutFilter	no
BackLight	no
OSDMenu	yes

Fieldeye

This is a list of models supported by this driver. The physical installation depends on the video encoder and the PTZ unit.

Important

Check what serial communication the video encoder and PTZ unit will support.

Supported models:

- FIELDEYE FC13U

Other models may be supported but this has not been verified by Axis.

Technical information

DEFAULT capabilities for PTZ driver:

Driver	Fieldeye
Version	4.00

DEFAULT serial configuration:

PortMode	RS485
BaudRate	9,600
DataBits	8
StopBits	1
Parity	None

DEFAULT supported capabilities in this PTZ driver:

Note

Different PTZ models may have other capabilities (both less and more).

Movement	Absolute	Relative	Continuous
Pan	no	yes	yes
Tilt	no	yes	yes
Zoom	no	yes	yes
Focus	no	yes	yes
Iris	no	yes	yes

AutoIris	yes
AutoFocus	yes
IrCutFilter	yes

BackLight	yes
OSDMenu	no

Forwardvision

This is a list of models supported by this driver. The physical installation depends on the video encoder and the PTZ unit.

Important

Check what serial communication the video encoder and PTZ unit will support.

Supported models:

- MIC1-400

Other models may be supported but this has not been verified by Axis.

Technical information

DEFAULT capabilities for PTZ driver:

Driver	Forwardvision
Version	4.04

DEFAULT serial configuration:

PortMode	RS485
BaudRate	9,600
DataBits	8
StopBits	1
Parity	Odd

DEFAULT supported capabilities in this PTZ driver:

Note

Different PTZ models may have other capabilities (both less and more).

Movement	Absolute	Relative	Continuous
Pan	yes	yes	yes
Tilt	yes	yes	yes
Zoom	yes	yes	yes
Focus	no	yes	no
Iris	no	yes	no

AutoIris	yes
AutoFocus	yes
IrCutFilter	no

BackLight	no
OSDMenu	no

Geutebrück

For more details, go to *KDec300*, on page 32.

JVC

This is a list of models supported by this driver. The physical installation depends on the video encoder and the PTZ unit.

Important

Check what serial communication the video encoder and PTZ unit will support.

- Supported models:
JVC TK-C676

Other models may be supported but this has not been verified by Axis.

Technical information

DEFAULT capabilities for PTZ driver:

Driver	JVC
Version	4.07

DEFAULT serial configuration:

PortMode	RS485
BaudRate	9,600
DataBits	8
StopBits	1
Parity	Even

DEFAULT supported capabilities in this PTZ driver:

Note

Different PTZ models may have other capabilities (both less and more).

Movement	Absolute	Relative	Continuous
Pan	no	yes	yes
Tilt	no	yes	yes
Zoom	no	yes	yes
Focus	no	yes	yes
Iris	no	yes	yes

Autolris	yes
AutoFocus	yes

IrCutFilter	no
BackLight	yes
OSDMenu	yes

Connection example

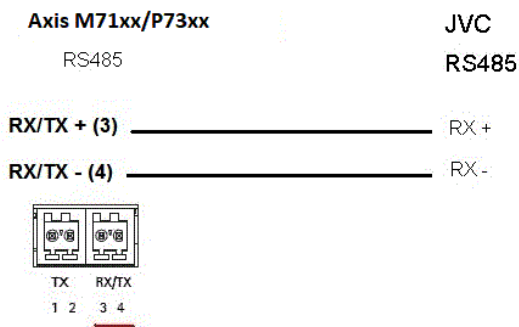

Kalatel

This is a list of models supported by this driver. The physical installation depends on the video encoder and the PTZ unit.

Important

Check what serial communication the video encoder and PTZ unit will support.

Supported models:

- Kalatel KTD-312 (Computer Interface/Data-merger)

Other models may be supported but this has not been verified by Axis.

Technical information

DEFAULT capabilities for PTZ driver:

Driver	Kalatel
Version	4.05

DEFAULT serial configuration:

PortMode	RS422
BaudRate	9,600
DataBits	8
StopBits	1
Parity	None

DEFAULT supported capabilities in this PTZ driver:

Note

Different PTZ models may have other capabilities (both less and more).

Movement	Absolute	Relative	Continuous
Pan	no	yes	yes
Tilt	no	yes	yes
Zoom	no	yes	yes
Focus	no	yes	yes
Iris	no	yes	yes

AutoIris	no
AutoFocus	yes
IrCutFilter	no
BackLight	no
OSDMenu	yes

Kalatel Digiplex

This is a list of models supported by this driver. The physical installation depends on the video encoder and the PTZ unit.

Important

Check what serial communication the video encoder and PTZ unit will support.

Supported models:

- Kalatel KTD-312 (Computer Interface/Data-merger)
- Cyberdome ver 1.0
- Cyberdome ver 1.2
- Cyberdome ver 2.0

Other models may be supported but this has not been verified by Axis.

KDec300

This is a list of models supported by this driver. The physical installation depends on the video encoder and the PTZ unit.

Important

Check what serial communication the video encoder and PTZ unit will support.

Supported models:

- Geutebruck KDec300 (Argus unit)

Other models may be supported but this has not been verified by Axis.

Lilin

This is a list of models supported by this driver. The physical installation depends on the video encoder and the PTZ unit.

Important

Check what serial communication the video encoder and PTZ unit will support.

Supported models:

- Lilin PIH-717

- Lilin PIH-7000

Other models may be supported but this has not been verified by Axis.

Technical information

DEFAULT capabilities for PTZ driver:

Driver	Lilin
Version	4.03

DEFAULT serial configuration:

PortMode	RS485
BaudRate	9,600
DataBits	8
StopBits	1
Parity	None

DEFAULT supported capabilities in this PTZ driver:

Note

Different PTZ models may have other capabilities (both less and more).

Movement	Absolute	Relative	Continuous
Pan	no	yes	yes
Tilt	no	yes	yes
Zoom	no	yes	yes
Focus	no	yes	yes
Iris	no	yes	no

AutoIris	yes
AutoFocus	yes
IrCutFilter	no
BackLight	no
OSDMenu	no

OpenEye

This is a list of models supported by this driver. The physical installation depends on the video encoder and the PTZ unit.

Important

Check what serial communication the video encoder and PTZ unit will support.

Supported models:

- OpenEye CM-510
- OpenEye CM-525

Other models may be supported but this has not been verified by Axis.

Panasonic

This is a list of models supported by this driver. The physical installation depends on the video encoder and the PTZ unit.

Important

Check what serial communication the video encoder and PTZ unit will support.

Supported models:

- Panasonic WV-CS850/CS854
- Panasonic WV-CS850A/CS854A

Other models may be supported but this has not been verified by Axis.

Panasonic WV-860/860A (Verified by third party).

Technical information

DEFAULT capabilities for PTZ driver:

Driver	Panasonic
Version	4.02

DEFAULT serial configuration:

PortMode	RS485
BaudRate	19,200
DataBits	8
StopBits	1
Parity	None

DEFAULT supported capabilities in this PTZ driver:

Note

Different PTZ models may have other capabilities (both less and more).

Movement	Absolute	Relative	Continuous
Pan	no	yes	yes
Tilt	no	yes	yes
Zoom	no	yes	yes
Focus	no	yes	yes
Iris	no	yes	no

AutoIris	yes
AutoFocus	yes
IrCutFilter	yes

BackLight	no
OSDMenu	yes

Connection example

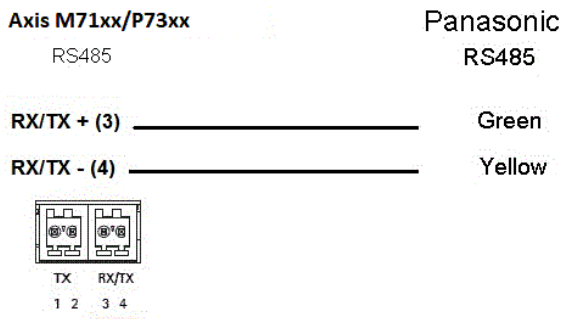

Pelco

This is a list of models supported by this driver. The physical installation depends on your Axis product and the PTZ unit.

Important

Check what serial communication your Axis product and the PTZ unit will support.

Supported models:

- Pelco DD5-C
- Pelco Esprit ES30C/ES31C
- Pelco LRD41C21
- Pelco LRD41C22
- Pelco Spectra III
- Pelco Spectra IV
- Pelco Spectra Mini
- Videotec DTRX3/PTH310P
- Videotec ULISSE
- PTK AMB
- YP3040

Other models may be supported but this has not been verified by Axis.

Technical information

DEFAULT capabilities for PTZ driver:

Driver	Pelco
Version	4.17

DEFAULT serial configuration:

PortMode	RS485
BaudRate	2,400

DataBits	8
StopBits	1
Parity	None

DEFAULT supported capabilities in this PTZ driver:

Note

Different PTZ units may have other capabilities (both less and more).

Movement	Absolute	Relative	Continuous
Pan	no	yes	yes
Tilt	no	yes	yes
Zoom	no	yes	yes
Focus	no	yes	yes
Iris	no	yes	yes

Autolris	yes
AutoFocus	yes
IrCutFilter	no
BackLight	yes
OSDMenu	yes

Connection example

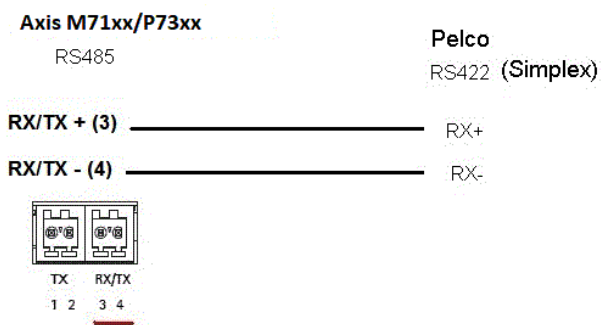

Philips

This is a list of models supported by this driver. The physical installation depends on the video encoder and the PTZ unit.

Important

Check what serial communication the video encoder and PTZ unit will support.

Supported models:

- Bosch/Philips Autodome G3A
- Bosch Autodome VG4
- Bosch MIC 400

- Bosch MIC 500

Other models may be supported but this has not been verified by Axis.

Technical information

DEFAULT capabilities for PTZ driver:

Driver	Philips
Version	4.06

DEFAULT serial configuration:

PortMode	RS485
BaudRate	19,200
DataBits	8
StopBits	1
Parity	None

DEFAULT supported capabilities in this PTZ driver:

Note

Different PTZ models may have other capabilities (both less and more).

Movement	Absolute	Relative	Continuous
Pan	no	yes	yes
Tilt	no	yes	yes
Zoom	no	yes	yes
Focus	no	yes	yes
Iris	no	yes	yes

AutoIris	yes
AutoFocus	yes
IrCutFilter	no
BackLight	yes
OSDMenu	yes

Connection example

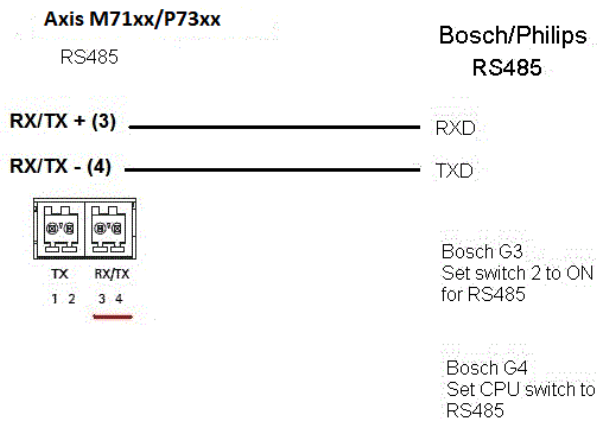

Samsung

This is a list of models supported by this driver. The physical installation depends on the video encoder and the PTZ unit.

Important

Check what serial communication the video encoder and PTZ unit will support.

Supported models:

- Samsung SCC-643
- Samsung SCP-2120

Other models may be supported but this has not been verified by Axis.

Technical information

DEFAULT capabilities for PTZ driver:

Driver	Samsung
Version	4.02

DEFAULT serial configuration:

PortMode	RS485
BaudRate	38,400
DataBits	8
StopBits	1
Parity	None

DEFAULT supported capabilities in this PTZ driver:

Note

Different PTZ models may have other capabilities (both less and more).

Movement	Absolute	Relative	Continuous
Pan	no	yes	yes
Tilt	no	yes	yes
Zoom	no	yes	yes

Movement	Absolute	Relative	Continuous
Focus	no	yes	yes
Iris	no	yes	yes

Autolris	no
AutoFocus	yes
IrCutFilter	no
BackLight	no
OSDMenu	yes

Connection example

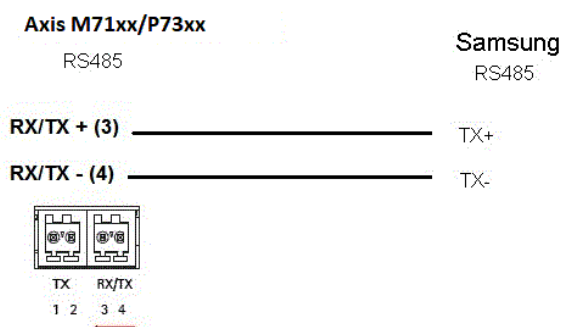

Sensormatic

This is a list of models supported by this driver. The physical installation depends on the video encoder and the PTZ unit.

Important

Check what serial communication the video encoder and PTZ unit will support.

Supported models:

- Sensormatic Ultra I
- Sensormatic Ultra II
- Sensormatic Ultra III
- Sensormatic Ultra V
- Sensormatic Ultra VII

Other models may be supported but this has not been verified by Axis.

Technical information

DEFAULT capabilities for PTZ driver:

Driver	Sensormatic
Version	4.09

DEFAULT serial configuration:

PortMode	RS485
BaudRate	4,800
DataBits	8
StopBits	1
Parity	None

DEFAULT supported capabilities in this PTZ driver:

Note

Different PTZ models may have other capabilities (both less and more).

Movement	Absolute	Relative	Continuous
Pan	no	yes	yes
Tilt	no	yes	yes
Zoom	no	yes	yes
Focus	no	yes	yes
Iris	no	yes	yes

AutoIris	yes
AutoFocus	yes
IrCutFilter	no
BackLight	no
OSDMenu	yes

Connection example

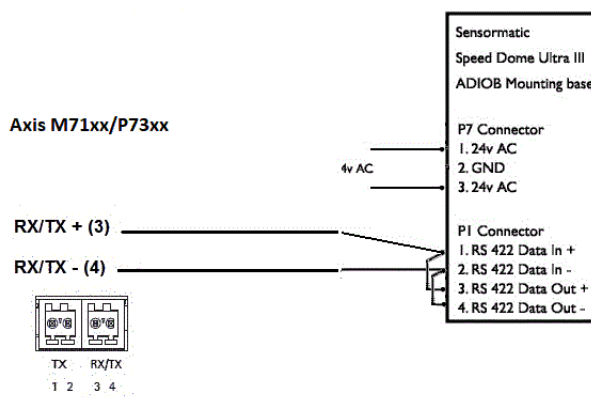

Siemens

This is a list of models supported by this driver. The physical installation depends on the video encoder and the PTZ unit.

Important

Check what serial communication the video encoder and PTZ unit will support.

Supported models:

- Siemens CCDA1435-DNX

Other models may be supported but this has not been verified by Axis.

Technical information

DEFAULT capabilities for PTZ driver:

Driver	Siemens
Version	1.00

DEFAULT serial configuration:

DuplexMode	Simplex or half duplex
PortMode	RS485
BaudRate	9,600
DataBits	8
StopBits	1
Parity	None

DEFAULT supported capabilities in this PTZ driver:

Note

Different PTZ models may have other capabilities (both less and more).

Movement	Absolute	Relative	Continuous
Pan	no	yes	yes
Tilt	no	yes	yes
Zoom	no	yes	yes
Focus	no	yes	yes
Iris	no	yes	yes

AutoIris	yes
AutoFocus	yes
IrCutFilter	no
BackLight	no
OSDMenu	yes

Smartscan

For more details, go to *Ultrak*, on page 42.

Teb

This is a list of models supported by this driver. The physical installation depends on the video encoder and the PTZ unit.

Important

Check what serial communication the video encoder and PTZ unit will support.

Supported models:

- Teb TUB

Other models may be supported but this has not been verified by Axis.

Technical information

DEFAULT capabilities for PTZ driver:

Driver	Teb
Version	4.00

DEFAULT serial configuration:

PortMode	RS422
BaudRate	9,600
DataBits	8
StopBits	1
Parity	None

DEFAULT supported capabilities in this PTZ driver:

Note

Different PTZ models may have other capabilities (both less and more).

Movement	Absolute	Relative	Continuous
Pan	no	yes	yes
Tilt	no	yes	yes
Zoom	no	yes	yes
Focus	no	yes	yes
Iris	no	yes	no

AutoIris	yes
AutoFocus	yes
IrCutFilter	no
BackLight	no
OSDMenu	yes

Ultrak

This is a list of models supported by this driver. The physical installation depends on the video encoder and the PTZ unit.

Important

Check what serial communication the video encoder and PTZ unit will support.

Supported models:

- Ultrak UltraDome KD6
- Ultrak UltraDome KD6i

Other models may be supported but this has not been verified by Axis.

Technical information

DEFAULT capabilities for PTZ driver:

Driver	Ultrak
Version	4.04

DEFAULT serial configuration:

PortMode	RS485
BaudRate	9,600
DataBits	8
StopBits	1
Parity	Even

DEFAULT supported capabilities in this PTZ driver:

Note

Different PTZ models may have other capabilities (both less and more).

Movement	Absolute	Relative	Continuous
Pan	yes	yes	yes
Tilt	yes	yes	yes
Zoom	yes	yes	yes
Focus	no	no	no
Iris	no	no	no

AutoIris	yes
AutoFocus	yes
IrCutFilter	yes
BackLight	yes
OSDMenu	no

Connection example

Axis M71xx/P73xx

RS485

UltraDome
KD6/KD6i

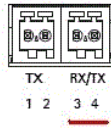
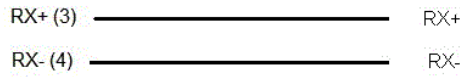

Make sure that the jumpers on the Top Plate are set to 2-wire operation (jumpers W3 and W4 to position 1 and 2).

VCC

This is a list of models supported by this driver. The physical installation depends on the video encoder and the PTZ unit.

Important

Check what serial communication the video encoder and PTZ unit will support.

Supported models:

- Canon VC-C4
- Canon VC-C4R
- Canon VC-C50i
- Canon VC-C50iR
- Canon NU-700N
- Canon NU-700P
- Canon NU-701N
- Canon NU-701P
- Canon BU-45H
- Canon BU-50H

Other models may be supported but this has not been verified by Axis.

VCL

This is a list of models supported by this driver. The physical installation depends on the video encoder and the PTZ unit.

Important

Check what serial communication the video encoder and PTZ unit will support.

Supported models:

- Vcl Orbiter MicroSphere
- Vcl Orbiter Gold

Other models may be supported but this has not been verified by Axis.

Technical information

DEFAULT capabilities for PTZ driver:

Driver	Vcl_rel
Version	4.04

DEFAULT serial configuration:

PortMode	RS485
BaudRate	9,600
DataBits	8
StopBits	2
Parity	None

DEFAULT supported capabilities in this PTZ driver:

Note

Different PTZ models may have other capabilities (both less and more).

Movement	Absolute	Relative	Continuous
Pan	no	yes	yes
Tilt	no	yes	yes
Zoom	no	yes	yes
Focus	no	yes	yes
Iris	no	yes	yes

Autolris	yes
AutoFocus	yes
IrCutFilter	no
BackLight	no
OSDMenu	no

Connection example

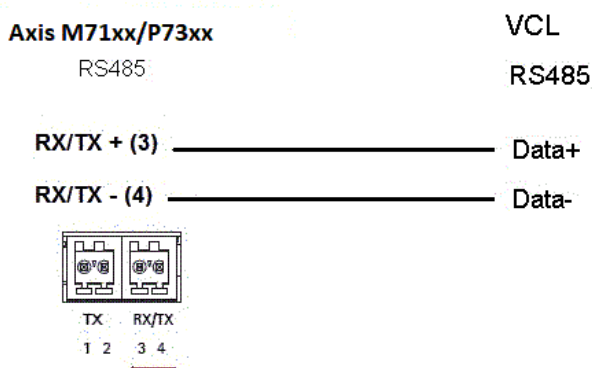

Vicon

This is a list of models supported by this driver. The physical installation depends on the video encoder and the PTZ unit.

Important

Check what serial communication the video encoder and PTZ unit will support.

Supported models:

- Vicon SVFT-W23

Other models may be supported but this has not been verified by Axis.

Technical information

DEFAULT capabilities for PTZ driver:

Driver	Vicon
Version	4.05

DEFAULT serial configuration:

PortMode	RS485
BaudRate	19,200
DataBits	8
StopBits	1
Parity	None

DEFAULT supported capabilities in this PTZ driver:

Note

Different PTZ models may have other capabilities (both less and more).

Movement	Absolute	Relative	Continuous
Pan	no	yes	yes
Tilt	no	yes	yes
Zoom	no	yes	yes
Focus	no	yes	yes
Iris	no	no	no

AutoIris	no
AutoFocus	no
IrCutFilter	no
BackLight	no
OSDMenu	yes

Videmech

This is a list of models supported by this driver. The physical installation depends on the video encoder and the PTZ unit.

Important

Check what serial communication the video encoder and PTZ unit will support.

Supported models:

- Videmech 682
- Videmech 555RX

Other models may be supported but this has not been verified by Axis.

Technical information

DEFAULT capabilities for PTZ driver:

Driver	Videmech
Version	4.06

DEFAULT serial configuration:

PortMode	RS485
BaudRate	9,600
DataBits	8
StopBits	1
Parity	Odd

DEFAULT supported capabilities in this PTZ driver:

Note

Different PTZ models may have other capabilities (both less and more).

Movement	Absolute	Relative	Continuous
Pan	yes	yes	yes
Tilt	yes	yes	yes
Zoom	yes	yes	yes
Focus	yes	yes	yes
Iris	no	no	no

Autolris	no
AutoFocus	no
IrCutFilter	no
BackLight	no
OSDMenu	no

Connection example

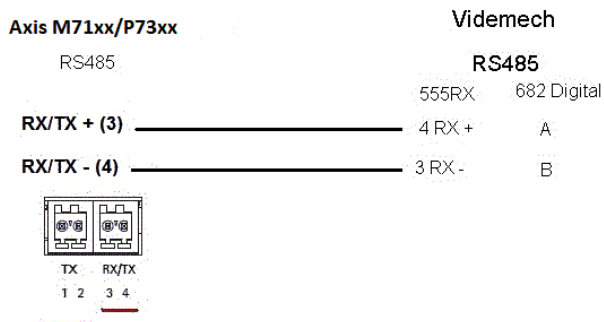

Videotec

This is a list of models supported by this driver. The physical installation depends on the video encoder and the PTZ unit.

Important

Check what serial communication the video encoder and PTZ unit will support.

Supported models:

- Videotec DTMRX2

Other models may be supported but this has not been verified by Axis.

Videotec Macro

This is a list of models supported by this driver. The physical installation depends on the video encoder and the PTZ unit.

Important

- Check what serial communication the video encoder and PTZ unit will support.
- The PTZ unit must support the Videotec Macro PTZ protocol.

Supported models:

- Videotec ULISSE

Other models may be supported but this has not been verified by Axis.

Technical information

DEFAULT capabilities for PTZ driver:

Driver	Videotec Macro
Version	1.22

DEFAULT serial configuration:

DuplexMode	Half duplex
PortMode	RS485
BaudRate	38,400
DataBits	8
StopBits	1
Parity	None

DEFAULT supported capabilities in this PTZ driver:

Note

Different PTZ models may have other capabilities (both less and more).

Movement	Absolute	Relative	Continuous
Pan	yes	yes	yes
Tilt	yes	yes	yes
Zoom	no	no	no

Movement	Absolute	Relative	Continuous
Focus	no	no	no
Iris	no	no	no

AutoIris	no
AutoFocus	no
IrCutFilter	no
BackLight	no
OSDMenu	no

Visca

This is a list of models supported by this driver. The physical installation depends on your Axis product and the PTZ unit.

Important

Check what serial communication your Axis product and the PTZ unit will support.

Supported models with RS422 4-wire interface:

- Sony EVI-D70/D70P
- WISKA DCP-27 (PT-head)

Supported models with RS232 interface (may require external RS422-4-wire/RS232 converter):

- Axis EVI-D30/D31
- Sony EVI-G20/G21
- Sony EVI-D30/D31
- Sony EVI-D100/D100P
- Sony EVI-D70/D70P

Other models may be supported but this has not been verified by Axis.

Technical information

DEFAULT capabilities for PTZ driver:

Driver	Visca/EVI
Version	4.11

DEFAULT serial configuration:

PortMode	RS422
BaudRate	9,600
DataBits	8
StopBits	1
Parity	None

DEFAULT supported capabilities in this PTZ driver:

Note

Different PTZ units may have other capabilities (both less and more).

Movement	Absolute	Relative	Continuous
Pan	yes	yes	yes
Tilt	yes	yes	yes
Zoom	yes	yes	yes
Focus	yes	yes	yes
Iris	yes	yes	no

AutoIris	yes
AutoFocus	yes
IrCutFilter	yes
BackLight	yes
OSDMenu	no

Cybersecurity

Cybersecurity supports a successful product lifecycle with minimized risks. You can find in-depth information and documentation about our cybersecurity approach at axis.com/about-axis/cybersecurity. Follow the cybersecurity guidelines below to receive product security notifications from Axis and to configure your product for a secure lifecycle and decommissioning.

At *Axis Trust Center*, you can find information about how Axis implements security compliance, transparency, data protection, and privacy.

Vulnerability management

Axis is a *Common Vulnerability and Exposures (CVE) Numbering Authority (CNA)*. To minimize your risk of exposure, we follow industry standards when identifying and resolving vulnerabilities in our devices, software, and services. Refer to axis.com/vulnerability-management for information about our vulnerability management policy or to report a vulnerability.

Security notifications

Subscribe to Axis security notification emails at axis.com/security-notification-service. We will send you information about vulnerabilities, corresponding security advisories, and other security-related matters for your Axis product.

Secure product lifecycle

Axis minimizes risks throughout the lifetime of our products through secure lifecycle management. Use our hardening guides at help.axis.com to more securely configure and operate your Axis products and to find information about:

Secure first-use – Axis products are pre-configured with high default protection to allow for secure initialization and encrypted communication from the very start.

Intended use and common configuration mistakes – Our guides provide information about the intended usage of Axis products, including common security-relevant misuse and configuration mistakes that should be avoided.

Managing vulnerabilities and supply chain transparency – A Software Bill of Material (SBOM) is published with every software release on axis.com to disclose vulnerabilities and improve supply chain transparency.

Decommissioning and the secure erasure of data – To securely decommission a product when it reaches the end of its lifecycle, reset it to factory default settings. This erases your configurations, stored data, and sensitive information.

T10156403

2026-07 (M17.2)

© 2021 – 2026 Axis Communications AB