

AXIS P9106-V Network Camera

User Manual

AXIS P9106-V Network Camera

Table of Contents

Solution overview	3
Product overview	4
Installation	5
Find the device on the network	6
Access the device	6
Additional settings	8
Need more help?	8
Image quality	8
Overlays	11
Streaming and storage	12
Events	14
Applications	15
Audio	16
Troubleshooting	18
Reset to factory default settings	18
Check the current firmware	18
Upgrade the firmware	18
Technical issues, clues and solutions	19
Performance considerations	21
Specifications	22
LED Indicators	22
SD card slot	22
Buttons	22
Connectors	22

AXIS P9106-V Network Camera

Solution overview

Solution overview

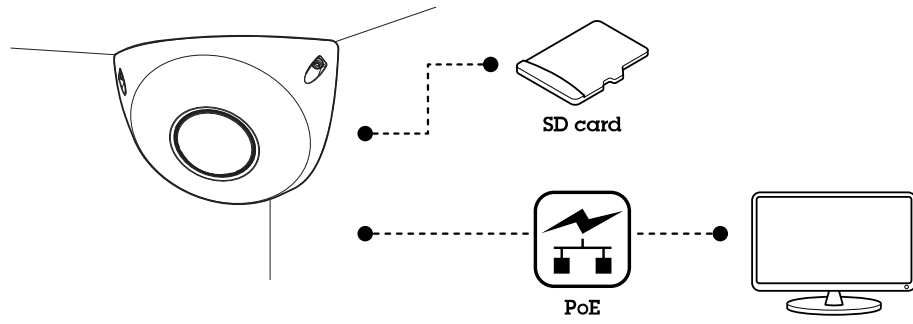

AXIS P9106-V Network Camera

Product overview

Product overview

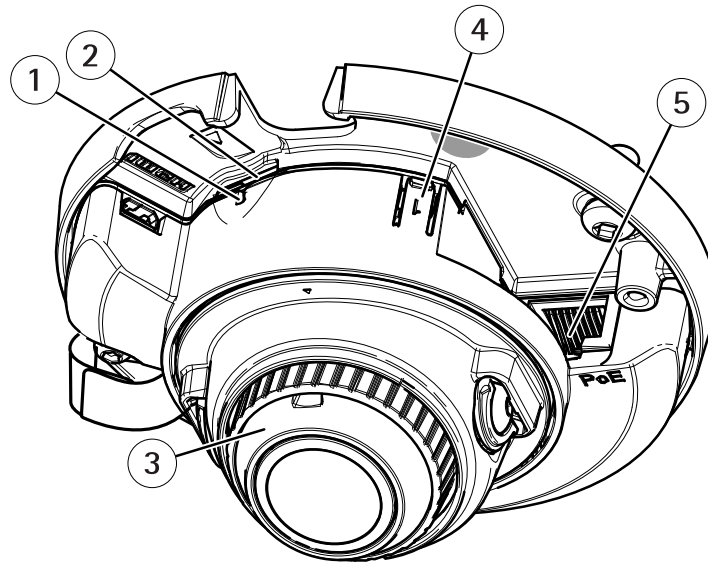

- 1 *Status LED*
- 2 *microSD card slot*
- 3 *Focus ring*
- 4 *Control button*
- 5 *Network connector (PoE)*

AXIS P9106-V Network Camera

Installation

Installation



To watch this video, go to the web version of this document.

www.axis.com/products/online-manual/43942#t10170578

Installation video for the product.

AXIS P9106-V Network Camera

Find the device on the network

Find the device on the network

To find Axis devices on the network and assign them IP addresses in Windows®, use AXIS IP Utility or AXIS Device Manager. Both applications are free and can be downloaded from axis.com/support.

For more information about how to find and assign IP addresses, go to *How to assign an IP address and access your device*.

Access the device

1. Open a browser and enter the IP address or host name of the Axis device.
If you do not know the IP address, use AXIS IP Utility or AXIS Device Manager to find the device on the network.
2. Enter the username and password. If you access the device for the first time, you must set the root password. See *Set a new password for the root account on page 6*.
3. The live view page opens in your browser.

Secure passwords

Important

Axis devices send the initially set password in clear text over the network. To protect your device after the first login, set up a secure and encrypted HTTPS connection and then change the password.

The device password is the primary protection for your data and services. Axis devices do not impose a password policy as they may be used in various types of installations.

To protect your data we strongly recommend that you:

- Use a password with at least 8 characters, preferably created by a password generator.
- Don't expose the password.
- Change the password at a recurring interval, at least once a year.

Set a new password for the root account

Important

The default administrator username is **root**. If the password for root is lost, reset the device to factory default settings. See *Reset to factory default settings on page 18*



To watch this video, go to the web version of this document.

www.axis.com/products/online-manual/43942#t10098905

Support tip: Password security confirmation check

1. Type a password. Follow the instructions about secure passwords. See *Secure passwords on page 6*.

AXIS P9106-V Network Camera

Find the device on the network

2. Retype the password to confirm the spelling.
3. Click **Create login**. The password has now been configured.

AXIS P9106-V Network Camera

Additional settings

Additional settings

Need more help?

You can access the built-in help from the device's webpage. The help provides more detailed information on the device's features and their settings.

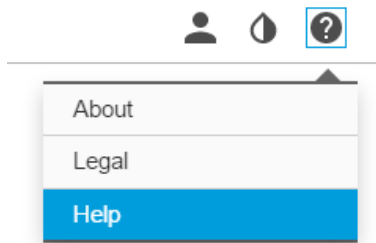

Image quality

Select exposure mode

There are different exposure mode options in the camera that adjusts aperture, shutter speed, and gain to improve image quality for specific surveillance scenes. Go to **Settings > Image > Exposure** and select between the following exposure modes:

- For most use cases, select **Automatic** exposure.
- For environments with certain artificial lighting, for example fluorescent lighting, select **Flicker-free**.
- For environments with certain artificial light and bright light, for example outdoors with fluorescent lighting at night and sun during daytime, select **Flicker-reduced**.
- To lock the current exposure settings, select **Hold current**.

View area

A view area is a cropped part of the full view. You can stream and store view areas instead of the full view to minimize bandwidth and storage needs. If you enable PTZ for a view area, you can pan, tilt and zoom within it. By using view areas you can remove parts of the full view, for example, the sky.

When you set up a view area, we recommend you to set the video stream resolution to the same size as or smaller than the view area size. If you set the video stream resolution larger than the view area size it implies digitally scaled up video after sensor capture, which requires more bandwidth without adding image information.

Privacy masks

A privacy mask is a user-defined area that prevents users from viewing a part of the monitored area. In the video stream, privacy masks appear as blocks of solid color.

You'll see the privacy mask on all snapshots, recorded video, and live streams.

You can use the VAPIX® application programming interface (API) to turn off the privacy masks.

Important

If you use multiple privacy masks it may affect the product's performance.

AXIS P9106-V Network Camera

Additional settings

Hide parts of the image with privacy masks

You can create one or several privacy masks to hide parts of the image.



How to create a privacy mask

1. Go to **Settings > Privacy mask**.
2. Click **New**.
3. Adjust the size, color, and name of the privacy mask according to your needs.



How to change the appearance of the mask

Verify the pixel resolution

To verify that a defined part of the image contains enough pixels to, for example, recognize the face of a person, you can use the pixel counter.

AXIS P9106-V

Additional settings

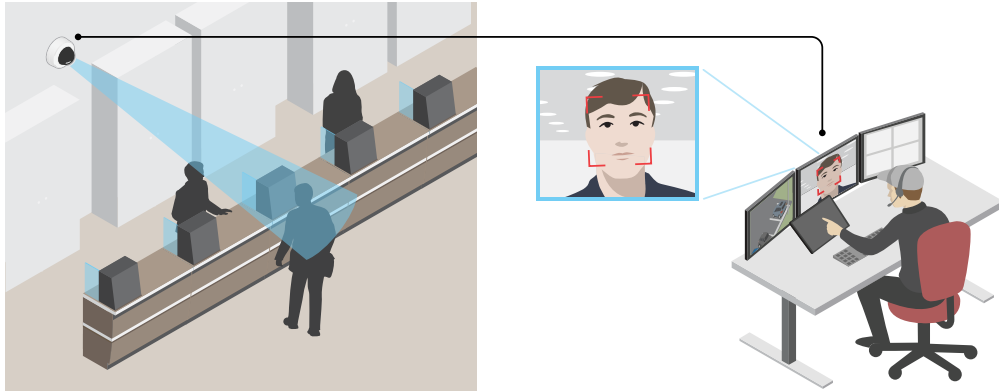

1. Go to **Settings > System > Orientation**.

2. Click .

3. In the camera's live view, adjust the size and position of the rectangle around the area of interest, for example where you expect faces to appear.

You can see the number of pixels for each of the rectangle's sides (X and Y), and decide if the values are enough for your needs.

Reduce noise in low-light conditions

To reduce noise in low-light conditions, you can adjust one or more of the following settings:

- Adjust the trade-off between noise and motion blur. Go to **Settings > Image > Exposure** and move the **Blur-noise trade-off** slider toward **Low noise**.
- Set the exposure mode to automatic.

Note

A high max shutter value can result in motion blur.

- To slow down the shutter speed, set max shutter to the highest possible value.
- Reduce sharpness in the image.
- Open the aperture.

Handle scenes with strong backlight

Dynamic range is the difference in light levels in an image. In some cases the difference between the darkest and the brightest areas can be significant. The result is often an image where either the dark or the bright areas are visible. Wide dynamic range (WDR) makes both dark and bright areas of the image visible.

AXIS P9106-V Network Camera

Additional settings



Image without WDR.



Image with WDR.

Note

- WDR can cause artifacts in the image.
 - WDR may not be available for all capture modes.
1. Go to **Settings > Image > Wide dynamic range**.
 2. Turn on WDR.
 3. If you still have problems, go to **Exposure** and adjust the **Exposure zone** to cover the area of interest.

Find out more about WDR and how to use it at axis.com/web-articles/wdr.

Maximize the details in an image

Important

If you maximize the details in an image, the bitrate will probably increase and you might get a reduced frame rate.

- Make sure to select the capture mode that has the highest resolution.
- Set the compression as low as possible.
- Select MJPEG streaming.
- Turn off Zipstream functionality.

Overlays

Overlays are superimposed over the video stream. They are used to provide extra information during recordings, such as a timestamp, or during product installation and configuration. You can add either text or an image.

AXIS P9106-V Network Camera

Additional settings

Show a text overlay in the video stream when the device detects motion

This example explains how to display the text "Motion detected" when the device detects motion.



How to show text overlay when the camera detects motion

Make sure that AXIS Video Motion Detection is running:

1. Go to **Settings > Apps > AXIS Video Motion Detection**.
2. Start the application if it is not already running.
3. Make sure you have set up the application according to your needs.

Add the overlay text:

4. Go to **Settings > Overlay**.
5. Enter #D in the text field.
6. Choose text size and appearance.

Create a rule:

7. Go to **System > Events > Rules** and add a rule.
8. Type a name for the rule.
9. In the list of conditions, select **AXIS Video Motion Detection**.
10. In the list of actions, select **Use overlay text**.
11. Select a view area.
12. Type "Motion detected".
13. Set the duration.
14. Click **Save**.

Streaming and storage

Bitrate control

With bitrate control, you can manage the bandwidth consumption of your video stream.

Variable bitrate (VBR)

With variable bitrate, the bandwidth consumption varies based on the level of activity in the scene. The more activity in the scene, the more bandwidth you need. You are guaranteed constant image quality but it requires storage margins.

AXIS P9106-V Network Camera

Additional settings

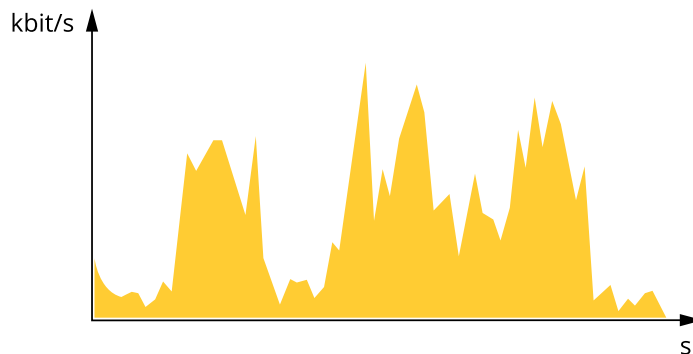

Maximum bitrate (MBR)

With maximum bitrate, you can set a target bitrate to handle bitrate limitations in your system. You may see a decline in image quality or frame rate when the instantaneous bitrate is kept below the specified target bitrate. You can choose to either prioritize image quality or frame rate. We recommend that you configure the target bitrate to a higher value than the expected bitrate. This gives you a margin for additional complexity that needs to be captured.

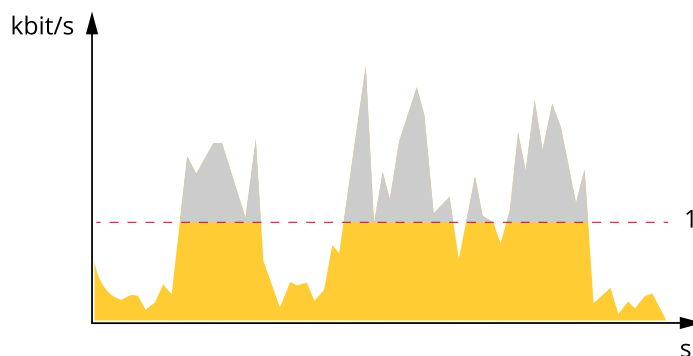

1 Target bitrate

Video compression formats

Decide which compression method to use based on your viewing requirements, and on the properties of your network. The available options are:

Motion JPEG

Motion JPEG, or MJPEG, is a digital video sequence that is made up of a series of individual JPEG images. These images are then displayed and updated at a rate sufficient to create a stream that shows constantly updated motion. For the viewer to perceive motion video the rate must be at least 16 image frames per second. Full motion video is perceived at 30 (NTSC) or 25 (PAL) frames per second.

The Motion JPEG stream uses considerable amounts of bandwidth, but provides excellent image quality and access to every image contained in the stream.

H.264 or MPEG-4 Part 10/AVC

Note

H.264 is a licensed technology. The Axis product includes one H.264 viewing client license. To install additional unlicensed copies of the client is prohibited. To purchase additional licenses, contact your Axis reseller.

AXIS P9106-V Network Camera

Additional settings

H.264 can, without compromising image quality, reduce the size of a digital video file by more than 80% compared to the Motion JPEG format and by as much as 50% compared to the MPEG-4 standard. This means that less network bandwidth and storage space are required for a video file. Or seen another way, higher video quality can be achieved for a given bitrate.

Reduce bandwidth and storage

Important

If you reduce the bandwidth it can result in loss of details in the picture.

1. Go to live view and select **H.264**.
2. Go to **Settings > Stream**.
3. Do one or more of the following:
 - Turn on the Zipstream functionality and select the desired level.
 - Turn on dynamic GOP and set a high GOP length value.
 - Increase the compression.
 - Turn on dynamic FPS.

Set up network storage

To store recordings on the network, you need to set up your network storage.

1. Go to **Settings > System > Storage**.
2. Click **Setup** under **Network storage**.
3. Enter the IP address of the host server.
4. Enter the name of the shared location on the host server.
5. Move the switch if the share requires a login, and enter username and password.
6. Click **Connect**.

Events

Set up rules and alerts

You can create rules to make your device perform an action when certain events occur. A rule consists of conditions and actions. The conditions can be used to trigger the actions. For example, the device can start a recording or send an email when it detects motion, or show an overlay text while the device is recording.

Trigger an action

1. Go to **Settings > System > Events** to set up a rule. The rule defines when the device will perform certain actions. Rules can be setup as scheduled, recurring, or for example, triggered by motion detection.
2. Select the **Condition** that must be met to trigger the action. If you specify more than one condition for the rule, all of the conditions must be met to trigger the action.
3. Select which **Action** the device should perform when the conditions are met.

Note

If you make changes to an active rule, you have to restart the rule for the changes to take effect.

AXIS P9106-V Network Camera

Additional settings

Record video when the camera detects motion

This example explains how to set up the camera to start recording to the SD card five seconds before it detects motion and to stop one minute after.



To watch this video, go to the web version of this document.

www.axis.com/products/online-manual/43942#t10106619

How to record a video stream when the camera detects motion

Make sure that AXIS Video Motion Detection is running:

1. Go to **Settings > Apps > AXIS Video Motion Detection**.
2. Start the application if it is not already running.
3. Make sure you have set up the application according to your needs. If you need help, see the *user manual for AXIS Video Motion Detection 4*.

Create a rule:

1. Go to **Settings > System > Events** and add a rule.
2. Type a name for the rule.
3. In the list of conditions, under **Application**, select **AXIS Video Motion Detection (VMD)**.
4. In the list of actions, under **Recordings**, select **Record video while the rule is active**.
5. Select an existing stream profile or create a new one.
6. Set the prebuffer time to 5 seconds.
7. Set the postbuffer time to 60 seconds.
8. In the list of storage options, select **SD card**.
9. Click **Save**.

Applications

AXIS Camera Application Platform (ACAP) is an open platform that enables third parties to develop analytics and other applications for Axis products. To find out more about available applications, downloads, trials and licenses, go to axis.com/applications.

To find the user manuals for Axis applications, go to axis.com.

Note

- Several applications can run at the same time but some applications might not be compatible with each other. Certain combinations of applications might require too much processing power or memory resources when run in parallel. Verify that the applications work together before deployment.

AXIS P9106-V Network Camera

Additional settings



To watch this video, go to the web version of this document.

www.axis.com/products/online-manual/43942#t10001688

How to download and install an application



To watch this video, go to the web version of this document.

www.axis.com/products/online-manual/43942#t10001688

How to activate an application licence code on a device

Audio

Add audio capability to your product

With the AXIS T61 Audio and I/O Interface products, you can add audio capability to your product. Use the setup in, for example, interview rooms. You can place the Axis network video product on the wall or ceiling to give good visual coverage, and the AXIS T61 Audio and I/O Interface on or above the interview table.

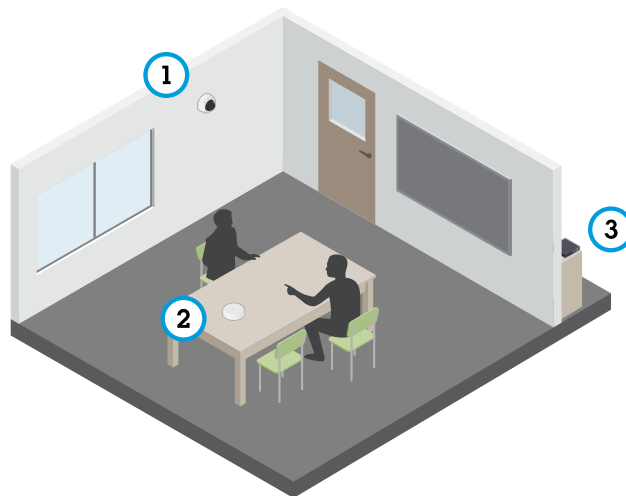

Interview room with AXIS T61 Series setup.

- 1 Axis network video device

AXIS P9106-V Network Camera

Additional settings

- 2 *AXIS T61 Audio and I/O Interface*
- 3 *PoE switch*

To add audio capability to your Axis network video device, connect the AXIS T61 Audio and I/O Interface between your device and the PoE switch which provides power.

1. Connect the Axis network video device (1) and the AXIS T61 Audio and I/O Interface (2) with a PoE cable.
2. Connect the AXIS T61 Audio and I/O Interface (2) and the PoE switch (3) with a PoE cable.



Once the devices are connected, an audio tab becomes visible in the settings for your Axis network video device. Go to the audio tab and turn on **Allow audio**.

See T61 user manual for further instructions.

AXIS P9106-V Network Camera

Troubleshooting

Troubleshooting

Reset to factory default settings

Important

Reset to factory default should be used with caution. A reset to factory default resets all settings, including the IP address, to the factory default values.

To reset the product to the factory default settings:

1. Disconnect power from the product.
2. Press and hold the control button while reconnecting power. See *Product overview on page 4*.
3. Keep the control button pressed for 15–30 seconds until the status LED indicator flashes amber.
4. Release the control button. The process is complete when the status LED indicator turns green. The product has been reset to the factory default settings. If no DHCP server is available on the network, the default IP address is 192.168.0.90.
5. Use the installation and management software tools to assign an IP address, set the password, and access the video stream.

The installation and management software tools are available from the support pages on axis.com/support.

It is also possible to reset parameters to factory default through the web interface. Go to **Settings > System > Maintenance** and click **Default**.

Check the current firmware

Firmware is the software that determines the functionality of network devices. One of your first actions when troubleshooting a problem should be to check the current firmware version. The latest version may contain a correction that fixes your particular problem.

To check the current firmware:

1. Go to the product's webpage.
2. Click the help menu .
3. Click **About**.

Upgrade the firmware

Important

Preconfigured and customized settings are saved when the firmware is upgraded (provided that the features are available in the new firmware) although this is not guaranteed by Axis Communications AB.

Important

Make sure the product remains connected to the power source throughout the upgrade process.

Note

When you upgrade the product with the latest firmware in the active track, the product receives the latest functionality available. Always read the upgrade instructions and release notes available with each new release before upgrading the firmware. To find the latest firmware and the release notes, go to axis.com/support/firmware.

AXIS Device Manager can be used for multiple upgrades. Find out more at axis.com/products/axis-device-manager.

AXIS P9106-V Network Camera

Troubleshooting



To watch this video, go to the web version of this document.

www.axis.com/products/online-manual/43942#t10095327

How to upgrade the firmware

1. Download the firmware file to your computer, available free of charge at axis.com/support/firmware.
2. Log in to the product as an administrator.
3. Go to **Settings > System > Maintenance**. Follow the instructions on the page. When the upgrade has finished, the product restarts automatically.

Technical issues, clues and solutions

If you can't find what you're looking for here, try the troubleshooting section at axis.com/support.

Problems upgrading the firmware

Firmware upgrade failure If the firmware upgrade fails, the device reloads the previous firmware. The most common reason is that the wrong firmware file has been uploaded. Check that the name of the firmware file corresponds to your device and try again.

Problems setting the IP address

The device is located on a different subnet If the IP address intended for the device and the IP address of the computer used to access the device are located on different subnets, you cannot set the IP address. Contact your network administrator to obtain an IP address.

The IP address is being used by another device Disconnect the Axis device from the network. Run the ping command (in a Command/DOS window, type `ping` and the IP address of the device):

- If you receive: `Reply from <IP address>: bytes=32; time=10...` this means that the IP address may already be in use by another device on the network. Obtain a new IP address from the network administrator and reinstall the device.
- If you receive: `Request timed out`, this means that the IP address is available for use with the Axis device. Check all cabling and reinstall the device.

Possible IP address conflict with another device on the same subnet The static IP address in the Axis device is used before the DHCP server sets a dynamic address. This means that if the same default static IP address is also used by another device, there may be problems accessing the device.

The device cannot be accessed from a browser

Cannot log in When HTTPS is enabled, ensure that the correct protocol (HTTP or HTTPS) is used when attempting to log in. You may need to manually type `http` or `https` in the browser's address field.

If the password for the user `root` is lost, the device must be reset to the factory default settings. See *Reset to factory default settings on page 18*.

AXIS P9106-V Network Camera

Troubleshooting

The IP address has been changed by DHCP	IP addresses obtained from a DHCP server are dynamic and may change. If the IP address has been changed, use AXIS IP Utility or AXIS Device Manager to locate the device on the network. Identify the device using its model or serial number, or by the DNS name (if the name has been configured). If required, a static IP address can be assigned manually. For instructions, go to axis.com/support .
Certificate error when using IEEE 802.1X	For authentication to work properly, the date and time settings in the Axis device must be synchronized with an NTP server. Go to Settings > System > Date and time .

The device is accessible locally but not externally

To access the device externally, we recommend using one of the following applications for Windows®:

- AXIS Companion: free of charge, ideal for small systems with basic surveillance needs.
- AXIS Camera Station: 30-day trial version free of charge, ideal for small to mid-size systems.

For instructions and download, go to axis.com/vms.

Problems with streaming

Multicast H.264 only accessible by local clients	Check if your router supports multicasting, or if the router settings between the client and the device need to be configured. The TTL (Time To Live) value may need to be increased.
No multicast H.264 displayed in the client	Check with your network administrator that the multicast addresses used by the Axis device are valid for your network. Check with your network administrator to see if there is a firewall preventing viewing.
Poor rendering of H.264 images	Ensure that your graphics card is using the latest driver. The latest drivers can usually be downloaded from the manufacturer's website.
Color saturation is different in H.264 and Motion JPEG	Modify the settings for your graphics adapter. Go to the adapter's documentation for more information.
Lower frame rate than expected	<ul style="list-style-type: none">• See <i>Performance considerations on page 21</i>.• Reduce the number of applications running on the client computer.• Limit the number of simultaneous viewers.• Check with the network administrator that there is enough bandwidth available.• Lower the image resolution.• Log in to the device's webpage and set a capture mode that prioritizes frame rate. Changing the capture mode to prioritize frame rate might lower the maximum resolution depending on the device used and capture modes available.• The maximum frames per second is dependent on the utility frequency (60/50 Hz) of the Axis device.

Problems retrieving additional video streams

'Video Error' displayed in AXIS Companion, or 'Stream: Error. Something went wrong. Maybe there are too many viewers.' in Chrome/Firefox, or '503 service unavailable' error in Quick Time, or 'Camera not available' displayed in AXIS Camera Station, or	This camera is designed to deliver up to four different streams. If a fifth unique stream is requested, the camera will not be able to provide it, and an error message is displayed. The error message depends on the way the stream is requested. The streams are used on a first come, first served basis. Examples of instances using a stream are: <ul style="list-style-type: none">• Live viewing in a web browser or other application• While recording - continuous or motion triggered recording• An event using images on the camera, for example an event sending an e-mail with an image every hour• An installed and running application, such as AXIS Video Motion Detection, will always consume a video stream, whether it is used or not. A stopped application does not consume a video stream. The camera can deliver more than four simultaneous streams provided the configuration of any additional stream is identical to any of the first four streams. Identical configuration implies exactly
---	---

AXIS P9106-V Network Camera

Troubleshooting

'Error reading video stream' message in browser when using the Java applet the same resolution, frame rate, compression, video format, rotation etc. For more information see the white paper "Max number of unique video stream configurations", available at axis.com.

Performance considerations

When setting up your system, it is important to consider how various settings and situations affect the performance. Some factors affect the amount of bandwidth (the bitrate) required, others can affect the frame rate, and some affect both. If the load on the CPU reaches its maximum, this also affects the frame rate.

The following factors are the most important to consider:

- High image resolution or lower compression levels result in images containing more data which in turn affects the bandwidth.
- Rotating the image in the GUI will increase the product's CPU load.
- Access by large numbers of Motion JPEG or unicast H.264 clients affects the bandwidth.
- Simultaneous viewing of different streams (resolution, compression) by different clients affects both frame rate and bandwidth.

Use identical streams wherever possible to maintain a high frame rate. Stream profiles can be used to ensure that streams are identical.

- Accessing Motion JPEG and H.264 video streams simultaneously affects both frame rate and bandwidth.
- Heavy usage of event settings affects the product's CPU load which in turn affects the frame rate.
- Using HTTPS may reduce frame rate, in particular if streaming Motion JPEG.
- Heavy network utilization due to poor infrastructure affects the bandwidth.
- Viewing on poorly performing client computers lowers perceived performance and affects frame rate.
- Running multiple AXIS Camera Application Platform (ACAP) applications simultaneously may affect the frame rate and the general performance.

AXIS P9106-V Network Camera

Specifications

Specifications

LED Indicators

Note

- The Status LED can be configured to flash while an event is active.
- The Status LED can be configured to flash for identifying the unit. Go to **Settings > System > Plain config**.

Status LED	Indication
Unlit	Connection and normal operation.
Green	Steady green for 10 seconds for normal operation after startup completed.
Amber	Steady during startup. Flashes during firmware upgrade or reset to factory default.
Amber/Red	Flashes amber/red if network connection is unavailable or lost.
Red	Firmware upgrade failure.

Note

Amber is a combination of red and green, and can be perceived as either of these colors depending on viewing angle.

SD card slot

NOTICE

- Risk of damage to SD card. Do not use sharp tools, metal objects, or excessive force when inserting or removing the SD card. Use your fingers to insert and remove the card.
- Risk of data loss and corrupted recordings. Do not remove the SD card while the product is running. Unmount the SD card from the product's webpage before removal.

This product supports microSD/microSDHC/microSDXC cards.

For SD card recommendations, see axis.com.



microSD, microSDHC, and microSDXC Logos are trademarks of SD-3C LLC. microSD, microSDHC, microSDXC are trademarks or registered trademarks of SD-3C, LLC in the United States, other countries or both.

Buttons

Control button

The control button is used for:

- Resetting the product to factory default settings. See *Reset to factory default settings on page 18*.

Connectors

HDMI Connector

The HDMI™ connector is not used by this product and it is not possible to get a video stream from it.

Network connector

RJ45 Ethernet connector with Power over Ethernet (PoE).

