

# AXIS Q3819-PVE Network Camera

Table of Contents

Installation ..... 4  
 Preview mode ..... 4  
 Get started..... 5  
 Find the device on the network..... 5  
     Browser support ..... 5  
 Open the device's web interface..... 5  
 Create an administrator account..... 5  
 Secure passwords..... 6  
 Make sure that no one has tampered with the device software ..... 6  
 Web interface overview ..... 6  
 Configure your device..... 7  
 Basic settings ..... 7  
 Adjust the image..... 7  
     Level the camera ..... 7  
     Benefit from IR light in low-light conditions by using night mode ..... 7  
     Reduce motion blur in low-light conditions..... 7  
     Maximize the details in an image ..... 8  
     Handle scenes with strong backlight..... 8  
     Verify the pixel resolution..... 8  
     Hide parts of the image with privacy masks..... 8  
     Show an image overlay ..... 9  
 View and record video ..... 9  
     Reduce bandwidth and storage ..... 9  
     View a live video stream on a monitor ..... 10  
     Set up network storage ..... 10  
     Record and watch video ..... 10  
 Set up rules for events ..... 10  
     Trigger an action ..... 10  
     Save power when no motion is detected ..... 10  
     Record video when the camera detects an object..... 11  
     Show a text overlay in the video stream when the device detects an object ..... 11  
     Record video when the camera detects loud noises ..... 12  
     Record video when the camera detects impact ..... 12  
     Provide visual indication of an ongoing event..... 13  
     Direct the camera and open the lock to a gate when someone is nearby..... 14  
     Trigger a notification when the enclosure is opened ..... 15  
     Set up the intrusion alarm ..... 15  
     Detect tampering with input signal ..... 16  
     Trigger a notification when the camera lens is tampered ..... 17  
 Audio..... 17  
     Add audio to your recording ..... 17  
     Connect to a network speaker..... 17  
 The web interface ..... 19  
 Learn more..... 20  
     Long-distance connections..... 20  
     Privacy masks ..... 20  
     Overlays ..... 20  
     Streaming and storage..... 20  
         Video compression formats..... 20  
         How do Image, Stream, and Stream profile settings relate to each other?..... 21  
         Bitrate control..... 21  
     Analytics and apps ..... 23  
         One-click PTZ control..... 23

- Metadata visualization..... 24
- Troubleshooting..... 25
  - Reset to factory default settings ..... 25
  - AXIS OS options ..... 25
  - Check the current AXIS OS version ..... 25
  - Upgrade AXIS OS..... 25
  - Technical problems and possible solutions ..... 26
  - Performance considerations ..... 28
  - Contact support ..... 29
- Clean your device..... 30
- Specifications..... 31
  - Product overview ..... 31
  - ..... 31
  - LED indicators..... 31
  - SD card slot..... 32
  - Buttons..... 32
    - Control button ..... 32
  - Connectors..... 32
    - Network connector ..... 32
    - I/O connector..... 32
- Cybersecurity ..... 34
  - Vulnerability management ..... 34
  - Security notifications..... 34
  - Secure product lifecycle..... 34

## Installation



*Installation video for the product.*

## Preview mode

Preview mode is ideal for installers when fine tuning the camera view during the installation. No login is required to access the camera view in preview mode. It is available only in factory defaulted state for a limited time from powering up the device.



*This video demonstrates how to use preview mode.*

## Get started

### Find the device on the network

To find Axis devices on the network and assign them IP addresses in Windows®, use AXIS IP Utility or AXIS Device Manager. Both applications are free and can be downloaded from [axis.com/support](http://axis.com/support).

For more information about how to find and assign IP addresses, go to *How to assign an IP address and access your device*.

### Browser support

You can use the device with the following browsers:

|                         | Chrome™ | Edge™ | Firefox® | Safari® |
|-------------------------|---------|-------|----------|---------|
| Windows®                | ✓       | ✓     | *        | *       |
| macOS®                  | ✓       | ✓     | *        | *       |
| Linux®                  | ✓       | ✓     | *        | *       |
| Other operating systems | *       | *     | *        | *       |

✓: Recommended

\*: Supported with limitations

### Open the device's web interface

1. Open a browser and type the IP address or host name of the Axis device.  
If you don't know the IP address, use AXIS IP Utility or AXIS Device Manager to find the device on the network.
2. Type the username and password. If you access the device for the first time, you must create an administrator account. See *Create an administrator account, on page 5*.

For descriptions of all features and settings in the web interface of devices with AXIS OS, see *AXIS OS web interface help*.

### Create an administrator account

The first time you log in to your device, you must create an administrator account.

1. Enter a username.
2. Enter a password. See *Secure passwords, on page 6*.
3. Re-enter the password.
4. Accept the license agreement.
5. Click **Add account**.

#### Important

The device has no default account. If you lose the password for your administrator account, you must reset the device. See *Reset to factory default settings, on page 25*.

### Secure passwords

#### Important

Use HTTPS (which is enabled by default) to set your password or other sensitive configurations over the network. HTTPS enables secure and encrypted network connections, thereby protecting sensitive data, such as passwords.

The device password is the primary protection for your data and services. Axis devices do not impose a password policy as they may be used in various types of installations.

To protect your data we strongly recommend that you:

- Use a password with at least 8 characters, preferably created by a password generator.
- Don't expose the password.
- Change the password at a recurring interval, at least once a year.

### Make sure that no one has tampered with the device software

To make sure that the device has its original AXIS OS, or to take full control of the device after a security attack:

1. Reset to factory default settings. See *Reset to factory default settings, on page 25*.  
After the reset, secure boot guarantees the state of the device.
2. Configure and install the device.

### Web interface overview

This video gives you an overview of the device's web interface.



*Axis device web interface*

## Configure your device

### Basic settings

#### Set the mounting position

1. Go to **Video > Installation > Mounting position**.
2. Click **Change**.
3. Select a mounting position and click **Save and restart**.

#### Set the power line frequency



1. Go to **Video > Installation > Power line frequency**.
2. Select a power line frequency and click **Save and restart**.

### Adjust the image

This section includes instructions about configuring your device. If you want to learn more about how certain features work, go to *Learn more, on page 20*.

#### Level the camera

To adjust the view in relation to a reference area or an object, use the level grid in combination with a mechanical adjustment of the camera.

1. Go to **Video > Image >** and click  **A**.
2. Click  to show the level grid.
3. Adjust the camera mechanically until the position of the reference area or the object is aligned with the level grid.

#### Benefit from IR light in low-light conditions by using night mode

Your camera uses visible light to deliver color images during the day. But as the visible light diminishes, color images become less bright and clear. If you switch to night mode when this happens, the camera uses both visible and near-infrared light to deliver bright and detailed black-and-white images instead. You can set the camera to switch to night mode automatically.

1. Go to **Video > Image > Day-night mode**, and make sure that the **IR-cut filter** is set to **Auto**.
2. To set at what light level you want the camera to switch to night mode, move the **Threshold** slider toward **Bright** or **Dark**.

#### Note

If you set the switch to night mode to occur when it's brighter, the image remains sharper as there is less low-light noise. If you set the switch to occur when it's darker, the image colors are maintained for longer, but there is more image blur due to low-light noise.

#### Reduce motion blur in low-light conditions

To reduce motion blur in low-light conditions, adjust one or more of the following settings in **Video > Image > Exposure**:

#### Note

When you increase the gain, image noise also increases.

- Set **Max shutter** to a shorter time, and **Max gain** to a higher value.

If you still have problems with motion blur:

- Increase the light level in the scene.

- Mount the camera so that objects move toward it or away from it rather than sideways.

## Maximize the details in an image

### Important

If you maximize the details in an image, the bitrate will probably increase and you might get a reduced frame rate.

- Make sure to select the capture mode that has the highest resolution.
- Go to **Video > Stream > General** and set the compression as low as possible.
- Below the live view image, click  and in **Video format**, select **MJPEG**.
- Go to **Video > Stream > Zipstream** and select **Off**.

## Handle scenes with strong backlight

Dynamic range is the difference in light levels in an image. In some cases the difference between the darkest and the brightest areas can be significant. The result is often an image where either the dark or the bright areas are visible. Wide dynamic range (WDR) makes both dark and bright areas of the image visible.



1. Go to **Video > Image > Wide dynamic range**.
2. Use the **Local contrast** slider to adjust the amount of WDR.
3. If you still have problems, go to **Exposure** and adjust the **Exposure zone** to cover the area of interest.

Find out more about WDR and how to use it at [axis.com/solutions/wide-dynamic-range-wdr](https://axis.com/solutions/wide-dynamic-range-wdr).

## Verify the pixel resolution

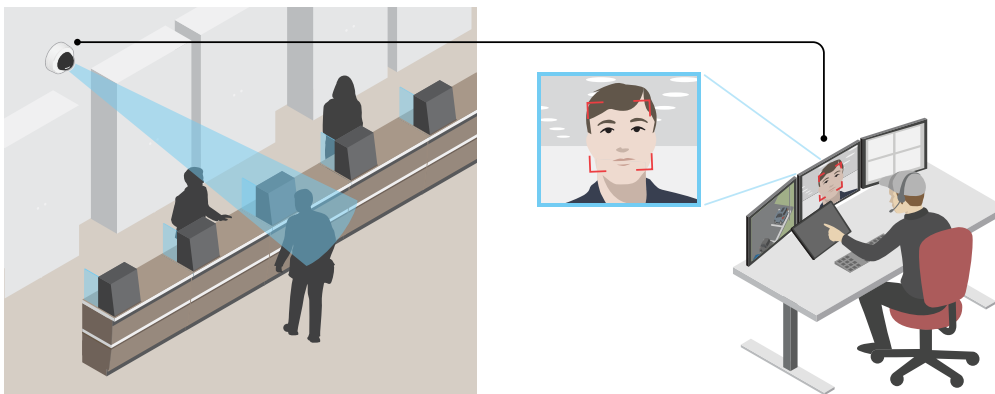
To verify that a defined part of the image contains enough pixels to, for example, recognize the face of a person, you can use the pixel counter.



1. Go to **Video > Image** and click .
2. Click  for **Pixel counter**.
3. In the camera's live view, adjust the size and position of the rectangle around the area of interest, for example where you expect faces to appear.  
You can see the number of pixels for each of the rectangle's sides, and decide if the values are enough for your needs.

## Hide parts of the image with privacy masks

You can create one or several privacy masks to hide parts of the image.

1. Go to **Video > Privacy masks**.
2. Click  .
3. Click the new mask and type a name.
4. Adjust the size and placement of the privacy mask according to your needs.
5. To change the color for all privacy masks, click **Privacy masks** and select a color.

See also *Privacy masks, on page 20*

### Show an image overlay

You can add an image as an overlay in the video stream.

1. Go to **Video > Overlays**.
2. Click **Manage images**.
3. Upload or drag and drop an image.
4. Click **Upload**.
5. Select **Image** from the drop-down list and click  .
6. Select the image and a position. You can also drag the overlay image in the live view to change the position.

### View and record video

This section includes instructions about configuring your device. To learn more about how streaming and storage works, go to *Streaming and storage, on page 20*.

### Reduce bandwidth and storage

#### Important

Reducing the bandwidth can lead to loss of detail in the image.

1. Go to **Video > Stream**.
2. Click  in the live view.
3. Select **Video format AV1** if your device supports it. Otherwise select **H.264**.
4. Go to **Video > Stream > General** and increase **Compression**.
5. Go to **Video > Stream > Zipstream** and do one or more of the following:

#### Note

The **Zipstream** settings are used for all video encodings except MJPEG.

- Select the **Zipstream Strength** that you want to use.
- Turn on **Optimize for storage**. This can only be used if the video management software supports B-frames.
- Turn on **Dynamic FPS**.
- Turn on **Dynamic GOP** and set a high **Upper limit GOP length** value.

#### Note

Most web browsers don't support H.265 decoding and because of this the device doesn't support it in its web interface. Instead you can use a video management system or application that supports H.265 decoding.

## View a live video stream on a monitor

### Set up network storage

To store recordings on the network, you need to set up your network storage.

1. Go to **System > Storage**.
2. Click  **Add network storage** under **Network storage**.
3. Type the IP address of the host server.
4. Type the name of the shared location on the host server under **Network share**.
5. Type the username and password.
6. Select the SMB version or leave it on **Auto**.
7. Select **Add share without testing** if you experience temporary connection issues, or if the share is not yet configured.
8. Click **Add**.

### Record and watch video

#### Record video directly from the camera

1. Go to **Video > Stream**.
2. To start a recording, click .

If you haven't set up any storage, click  and . For instructions on how to set up network storage, see *Set up network storage, on page 10*

3. To stop recording, click  again.

#### Watch video

1. Go to **Recordings**.
2. Click  for your recording in the list.

### Set up rules for events

You can create rules to make your device perform an action when certain events occur. A rule consists of conditions and actions. The conditions can be used to trigger the actions. For example, the device can start a recording or send an email when it detects motion, or show an overlay text while the device is recording.

To learn more, see *Get started with rules for events*.

#### Trigger an action

1. Go to **System > Events** and add a rule. The rule defines when the device will perform certain actions. You can set up rules as scheduled, recurring, or manually triggered.
2. Enter a **Name**.
3. Select the **Condition** that must be met to trigger the action. If you specify more than one condition for the rule, all of the conditions must be met to trigger the action.
4. Select which **Action** to perform when the conditions are met.

#### Save power when no motion is detected

This example explains how to turn on power saving mode when no motion is detected in the scene.

### Note

When you turn on power saving mode, the IR illumination range is reduced.

Make sure that AXIS Object Analytics is running:

1. Go to **Apps > AXIS Object Analytics**.
2. Start the application if it is not already running.
3. Make sure you have set up the application according to your needs.

Create a rule:

1. Go to **System > Events** and add a rule.
2. Type a name for the rule.
3. In the list of conditions, under **Application**, select **Object Analytics**.
4. Select **Invert this condition**.
5. In the list of actions, under **Power saving mode**, select **Use power saving mode while the rule is active**.
6. Click **Save**.

### Record video when the camera detects an object

This example explains how to set up the camera to start recording to the SD card when the camera detects an object. The recording will include five seconds before detection and one minute after detection ends.

Before you start:

- Make sure you have an SD card installed.

Make sure that AXIS Object Analytics is running:

1. Go to **Apps > AXIS Object Analytics**.
2. Start the application if it is not already running.
3. Make sure you have set up the application according to your needs.

Create a rule:

1. Go to **System > Events** and add a rule.
2. Type a name for the rule.
3. In the list of conditions, under **Application**, select **Object Analytics**.
4. In the list of actions, under **Recordings**, select **Record video while the rule is active**.
5. In the list of storage options, select **SD\_DISK**.
6. Select a camera and a stream profile.
7. Set the prebuffer time to 5 seconds.
8. Set the postbuffer time to 1 minute.
9. Click **Save**.

### Show a text overlay in the video stream when the device detects an object



This example explains how to display the text "Motion detected" when the device detects an object.

Make sure that AXIS Object Analytics is running:

1. Go to **Apps > AXIS Object Analytics**.
2. Start the application if it is not already running.
3. Make sure you have set up the application according to your needs.

Add the overlay text:

1. Go to **Video > Overlays**.

2. Under **Overlays**, select **Text** and click .
3. Enter #D in the text field.
4. Choose text size and appearance.
5. To position the text overlay, click  and select an option.

Create a rule:

1. Go to **System > Events** and add a rule.
2. Type a name for the rule.
3. In the list of conditions, under **Application**, select **Object Analytics**.
4. In the list of actions, under **Overlay text**, select **Use overlay text**.
5. Select a video channel.
6. In **Text**, type "Motion detected".
7. Set the duration.
8. Click **Save**.

**Note**

If you update the overlay text it will be automatically updated on all video streams dynamically.

### Record video when the camera detects loud noises

This example explains how to set up the camera to start recording to the SD card five seconds before it detects loud noise and to stop two minutes after.

Turn on audio:

1. Set up the stream profile to include audio, see *Add audio to your recording, on page 17*.

Turn on audio detection:

1. Go to **System > Detectors > Audio detection**.
2. Adjust the sound level according to your needs.

Create a rule:

1. Go to **System > Events** and add a rule.
2. Type a name for the rule.
3. In the list of conditions, under **Audio**, select **Audio Detection**.
4. In the list of actions, under **Recordings**, select **Record video**.
5. In the list of storage options, select **SD\_DISK**.
6. Select the stream profile where audio has been turned on.
7. Set the prebuffer time to 5 seconds.
8. Set the postbuffer time to 2 minutes.
9. Click **Save**.

### Record video when the camera detects impact

Shock detection allows the camera to detect tampering caused by vibrations or shock. Vibrations due to the environment or to an object can trigger an action depending on the shock sensitivity range, which can be set from 0 to 100. In this scenario, someone is throwing rocks at the camera after hours and you would like to get a video clip of the event.

Turn on shock detection:

1. Go to **System > Detectors > Shock detection**.
2. Turn on shock detection, and adjust the shock sensitivity.

### Create a rule:

3. Go to **System > Events > Rules** and add a rule.
4. Type a name for the rule.
5. In the list of conditions, under **Device status**, select **Shock detected**.
6. Click **+** to add a second condition.
7. In the list of conditions, under **Scheduled and recurring**, select **Schedule**.
8. In the list of schedules, select **After hours**.
9. In the list of actions, under **Recordings**, select **Record video while the rule is active**.
10. Select where to save the recordings.
11. Select a **Camera**.
12. Set the prebuffer time to 5 seconds.
13. Set the postbuffer time to 50 seconds.
14. Click **Save**.

### Provide visual indication of an ongoing event

You have the option to connect the AXIS I/O Indication LED to your network camera. This LED can be configured to turn on whenever certain events occur in the camera. For example, to let people know that video recording is in progress.



#### Required hardware

- AXIS I/O Indication LED
- An Axis network video camera

#### Note

For instructions on how to connect the AXIS I/O Indication LED, see the installation guide provided with the product.

The following example shows how to configure a rule that turns on the AXIS I/O Indication LED to indicate that camera is recording.

1. Go to **System > Accessories > I/O ports**.
2. For the port that you connected the AXIS I/O Indication LED to, click  to set the direction to **Output**, and click  to set the normal state to **Circuit open**.
3. Go to **System > Events**.
4. Create a new rule.
5. Select the **Condition** that must be met to trigger the camera to start recording. It can, for example, be a time schedule or motion detection.
6. In the list of actions, select **Record video**. Select a storage space. Select a stream profile or create a new. Also set the **Prebuffer** and **Postbuffer** as required.
7. Save the rule.
8. Create a second rule and select the same **Condition** as in the first rule.
9. In the list of actions, select **Toggle I/O while the rule is active**, and then select the port the AXIS I/O Indication LED is connected to. Set the state to **Active**.
10. Save the rule.

Other scenarios where AXIS I/O Indication LED can be used are for example:

- Configure the LED to turn on when the camera starts, to indicate the presence of the camera. Select **System ready** as a condition.

- Configure the LED to turn on when live stream is active to indicate that a person or a program is accessing a stream from the camera. Select **Live stream accessed** as a condition.

### Direct the camera and open the lock to a gate when someone is nearby

This example explains how to direct the camera and open a gate when someone wants to enter during daytime. This is done by connecting a PIR detector to the product's input port and a switch relay to the product's output port.

#### Required hardware

- Mounted PIR detector
- Switch relay connected to the gate lock, in this case the switch is normally closed (NC)
- Connecting wires



#### Physical connection

1. Connect the wires from the PIR detector to the input pin, see *I/O connector, on page 32*.
2. Connect the wires from the switch to the output pin, see *I/O connector, on page 32*



#### Configure I/O ports

You need to connect the switch relay to the camera from the camera's web interface. First, configure the I/O ports:

##### Set the PIR detector to an input port

1. Go to **System > Accessories > I/O ports**.
2. Click  to set the direction to input for port 1.
3. Give the input module a descriptive name, for example "PIR detector".
4. If you want to trigger an event whenever the PIR detector senses motion, click  to set the normal state to circuit open.

##### Set the switch relay to an output port

1. Click  to set the direction to output for port 2.
2. Give the output module a descriptive name, for example "Gate switch".
3. If you want to open the gate whenever an event is triggered, click  to set the normal state to circuit closed.

#### Create the preset position

1. Go to **PTZ > Preset positions**.
2. Create the preset position that covers the entrance of the gate and name it, for example, "Gate entrance".

#### Create rules

For the camera to open the gate when the PIR detector senses someone nearby, you need to create a rule in the camera:

1. Go to **System > Events** and add a rule.
2. Type a name for the rule, for example "Open gate".
3. In the list of conditions, select **PIR detector**.

4. In the list of actions, select **Toggle I/O once**.
5. In the list of ports, select **Gate switch**.
6. Set state to **Active**.
7. Set the duration.
8. Click **Save**.
9. Create another rule with the name "Direct the camera to the gate".
10. Select the same input signal as before, but as action select the previously created "Gate entrance" preset position.
11. Click **Save**.

### Trigger a notification when the enclosure is opened

This example explains how to set up an email notification when the housing or casing of the device is opened.

#### Add an email recipient:

1. Go to **System > Events > Recipients** and click **Add recipient**.
2. Type a name for the recipient.
3. Select **Email** as the notification type.
4. Type the recipient's email address.
5. Type the email address that you want the camera to send notifications from.
6. Provide the login details for the sending email account, along with the SMTP hostname and port number.
7. To test your email setup, click **Test**.
8. Click **Save**.

#### Create a rule:

9. Go to **System > Events > Rules** and click **Add a rule**.
10. Type a name for the rule.
11. In the list of conditions, select **Casing open**.
12. In the list of actions, select **Send notification to email**.
13. Select a recipient from the list.
14. Type a subject line and message for the email.
15. Click **Save**.

### Set up the intrusion alarm

#### Before you start

- Connect the intrusion alarm switch to pin 1 (ground) and pin 3 (digital I/O) of the camera's I/O connector.

#### Configure the input port:

1. Go to **System > Accessories > I/O ports**.
2. For **Port 1**:
  - 2.1. Select **Input**.
  - 2.2. Select **Circuit closed**.

#### Add an email recipient:

3. Go to **System > Events > Recipients** and click **Add recipient**.
4. Type a name for the recipient.

5. Select **Email** as the notification type.
6. Type the recipient's email address.
7. Type the email address that you want the camera to send notifications from.
8. Provide the login details for the sending email account, along with the SMTP hostname and port number.
9. To test your email setup, click **Test**.
10. Click **Save**.

**Create a rule:**

11. Go to **System > Events > Rules** and add a rule.
12. Type a name for the rule.
13. In the list of conditions, under **I/O**, select **Digital input**.
14. In the list of ports, select **Port 1**.
15. In the list of actions, under **Notifications**, select **Send notification to email**.
16. Select a recipient from the list or go to **Recipients** to create a new recipient.  
To create a new recipient, click **+**. To copy an existing recipient, click .
17. Type a subject line and message for the email.
18. Click **Save**.

**Detect tampering with input signal**

This example explains how to send an email when the input signal is cut or short-circuited. For more information about the I/O connector, see *page 32*.

1. Go to **System > Accessories > I/O ports** and turn on **Supervised** for the relevant port.

**Add an email recipient:**

1. Go to **System > Events > Recipients** and add a recipient.
2. Type a name for the recipient.
3. Select **Email** as the notification type.
4. Type the recipient's email address.
5. Type the email address that you want the camera to send notifications from.
6. Provide the login details for the sending email account, along with the SMTP hostname and port number.
7. To test your email setup, click **Test**.
8. Click **Save**.

**Create a rule:**

1. Go to **System > Events > Rules** and add a rule.
2. Type a name for the rule.
3. In the list of conditions, under **I/O**, select **Supervised input tampering is active**.
4. Select the relevant port.
5. In the list of actions, under **Notifications**, select **Send notification to email** and then select the recipient from the list.
6. Type a subject line and message for the email.
7. Click **Save**.

## Trigger a notification when the camera lens is tampered

This example explains how to set up an email notification when the camera lens gets either spray painted, covered, or blurred.

### Activate the tampering detection:

1. Go to **System > Detectors > Camera tampering**.
2. Set a value for **Trigger delay**. The value indicates the time that must pass before an email is sent.
3. Turn on **Trigger on dark images** to detect if the lens is sprayed, covered, or rendered severely out of focus.

### Add an email recipient:

4. Go to **System > Events > Recipients** and add a recipient.
5. Type a name for the recipient.
6. Select **Email** as the notification type.
7. Type the recipient's email address.
8. Type the email address that you want the camera to send notifications from.
9. Provide the login details for the sending email account, along with the SMTP hostname and port number.
10. To test your email setup, click **Test**.
11. Click **Save**.

### Create a rule:

12. Go to **System > Events > Rules** and add a rule.
13. Type a name for the rule.
14. In the list of conditions, under **Video**, select **Tampering**.
15. In the list of actions, under **Notifications**, select **Send notification to email** and then select the recipient from the list.
16. Type a subject line and message for the email.
17. Click **Save**.

## Audio

### Add audio to your recording

#### Turn on audio:

1. Go to **Video > Stream > Audio** and include audio.
2. If the device has more than one input source, select the correct one in **Source**.
3. Go to **Audio > Device settings** and turn on the correct input source.

#### Edit the stream profile that is used for the recording:

4. Go to **System > Stream profiles** and select the stream profile.
5. Select **Include audio** and turn it on.
6. Click **Save**.

### Connect to a network speaker

Network speaker pairing allows you to use a compatible Axis network speaker as if it is connected directly to the camera. Once paired, the speaker acts as an audio out device where you can play audio clips and transmit sound through the camera.

### Important

For this feature to work with a video management software (VMS), you must first pair the camera with the network speaker, then add the camera to your VMS.

#### Pair camera with network speaker

1. Go to **System > Edge-to-edge > Pairing**.
2. Click  **Add** and select the pairing type **Audio** from the drop-down list.
3. Select **Speaker pairing**.
4. Type the network speaker's IP address, username and password.
5. Click **Connect**. A confirmation message appears.

## The web interface

To read about all the features and settings available in the web interface of devices with AXIS OS, go to *AXIS OS web interface help*.

## Learn more

### Long-distance connections

This product supports fiber-optic cable installations through a media converter. Fiber-optic cable installations offer a number of benefits such as:

- Long-distance connection
- High speed
- Long lifetime
- Large capacity of data transmission
- Electromagnetic interference immunity

Find out more about fiber-optic cable installations in the white paper "Long distance surveillance - Fiber-optic communication in network video" at [axis.com/learning/white-papers](http://axis.com/learning/white-papers).

For information about how to install the media converter see the Installation Guide for this product.

### Privacy masks

A privacy mask is a user-defined area that covers a part of the monitored area. In the video stream, privacy masks appear either as blocks of solid color or with a mosaic pattern.

You'll see the privacy mask on all snapshots, recorded video, and live streams.

You can use the VAPIX® application programming interface (API) to hide the privacy masks.

#### Important

If you use multiple privacy masks it may affect the product's performance.

You can create several privacy masks. Each mask can have 3 to 10 anchor points.

### Overlays

Overlays are superimposed over the video stream. They are used to provide extra information during recordings, such as a timestamp, or during product installation and configuration. You can add either text or an image.

### Streaming and storage

#### Video compression formats

Decide which compression method to use based on your viewing requirements, and on the properties of your network. The available options are:

##### Motion JPEG

Motion JPEG, or MJPEG, is a digital video sequence that is made up of a series of individual JPEG images. These images are then displayed and updated at a rate sufficient to create a stream that shows constantly updated motion. For the viewer to perceive motion video the rate must be at least 16 image frames per second. Full motion video is perceived at 30 (NTSC) or 25 (PAL) frames per second.

The Motion JPEG stream uses considerable amounts of bandwidth, but provides excellent image quality and access to every image contained in the stream.

##### H.264 or MPEG-4 Part 10/AVC

#### Note

H.264 is a licensed technology. The Axis product includes one H.264 viewing client license. To install additional unlicensed copies of the client is prohibited. To purchase additional licenses, contact your Axis reseller.

H.264 can, without compromising image quality, reduce the size of a digital video file by more than 80% compared to the Motion JPEG format and by as much as 50% compared to older MPEG formats. This means that less network bandwidth and storage space are required for a video file. Or seen another way, higher video quality can be achieved for a given bitrate.

### H.265 or MPEG-H Part 2/HEVC

H.265 can, without compromising image quality, reduce the size of a digital video file by more than 25% compared to H.264.

#### Note

- H.265 is licensed technology. The Axis product includes one H.265 viewing client license. Installing additional unlicensed copies of the client is prohibited. To purchase additional licenses, contact your Axis reseller.
- Most web browsers don't support H.265 decoding and because of this the camera doesn't support it in its web interface. Instead you can use a video management system or application supporting H.265 decoding.

### How do Image, Stream, and Stream profile settings relate to each other?

The **Image** tab contains camera settings that affect all video streams from the product. If you change something in this tab, it immediately affects all video streams and recordings.

The **Stream** tab contains settings for video streams. You get these settings if you request a video stream from the product and don't specify for example resolution, or frame rate. When you change the settings in the **Stream** tab, it doesn't affect ongoing streams, but it will take effect when you start a new stream.

The **Stream profiles** settings override the settings from the **Stream** tab. If you request a stream with a specific stream profile, the stream contains the settings of that profile. If you request a stream without specifying a stream profile, or request a stream profile that doesn't exist in the product, the stream contains the settings from the **Stream** tab.

### Bitrate control

Bitrate control helps you to manage the bandwidth consumption of your video stream.

#### Variable bitrate (VBR)

Variable bitrate allows the bandwidth consumption to vary depending on the level of activity in the scene. The more activity, the more bandwidth you need. With variable bitrate you are guaranteed constant image quality, but you need to make sure you have storage margins.

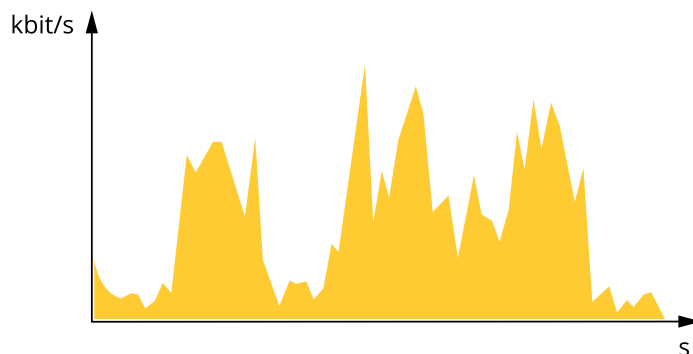

#### Maximum bitrate (MBR)

Maximum bitrate lets you set a target bitrate to handle bitrate limitations in your system. You might see a decline in image quality or frame rate as the instantaneous bitrate is kept below the specified target bitrate. You can choose to prioritize either image quality or frame rate. We recommend that you configure the target bitrate to a higher value than the expected bitrate. This gives you a margin in case there is a high level of activity in the scene.

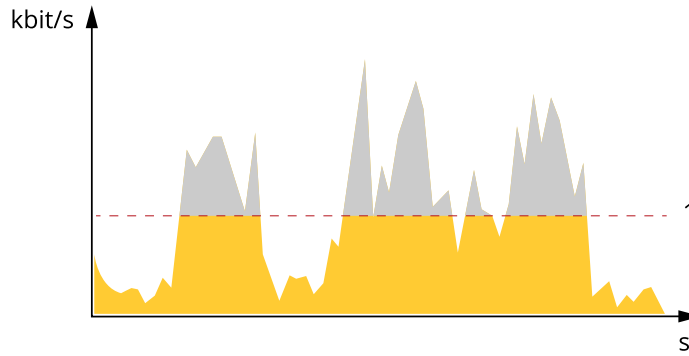

1 Target bitrate

**Average bitrate (ABR)**

With average bitrate, the bitrate is automatically adjusted over a longer period of time. This is so you can meet the specified target and provide the best video quality based on your available storage. Bitrate is higher in scenes with a lot of activity, compared to static scenes. You are more likely to get better image quality when in scenes with a lot of activity if you use the average bitrate option. You can define the total storage required to store the video stream for a specified amount of time (retention time) when image quality is adjusted to meet the specified target bitrate. Specify the average bitrate settings in one of the following ways:

- To calculate the estimated storage need, set the target bitrate and the retention time.
- To calculate the average bitrate, based on available storage and required retention time, use the target bitrate calculator.

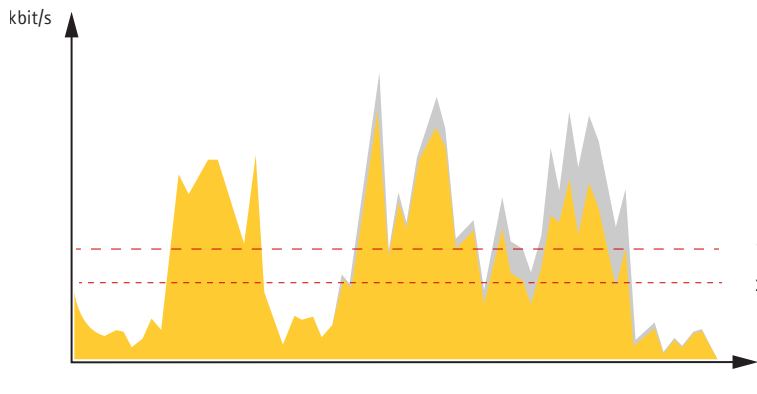

1 Target bitrate  
2 Actual average bitrate

You can also turn on maximum bitrate and specify a target bitrate within the average bitrate option.

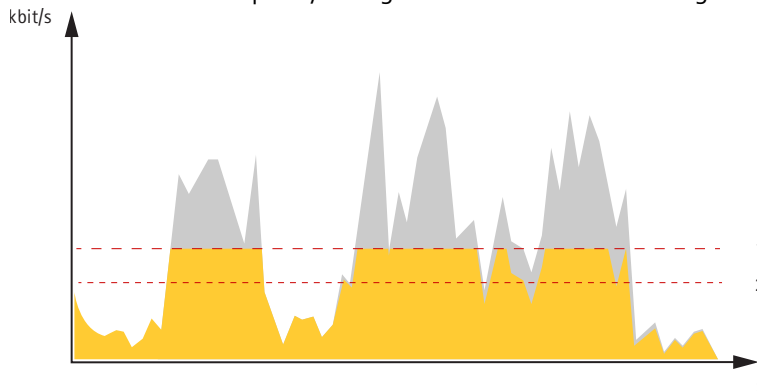

1 Target bitrate  
2 Actual average bitrate

## Analytics and apps

With analytics and apps you can get more out of your Axis device. AXIS Camera Application Platform (ACAP) is an open platform that makes it possible for third parties to develop analytics and other apps for Axis devices. Apps can be preinstalled on the device, available for download for free, or for a license fee.

To find the user manuals for Axis analytics and apps, go to [help.axis.com](http://help.axis.com).

### Note

- Several apps can run at the same time but some apps might not be compatible with each other. Certain combinations of apps might require too much processing power or memory resources when run in parallel. Verify that the apps work together before deployment.

## One-click PTZ control

With one-click PTZ control you can connect your panoramic camera to a remote Axis PTZ camera and control it from the live view. This gives you the option to combine your panoramic camera's wide coverage with PTZ functionality, such as following moving objects and zooming in/out.

### Note

Install the PTZ camera within 1 m (3 ft.) from your panoramic camera when you use one-click PTZ control.

## Configure one-click PTZ control



*How to configure one-click PTZ control in Axis panoramic cameras.*

1. Download and install the required configuration apps:
  - 1.1. Click  and select **Legacy device interface**.
  - 1.2. Go to **Settings > System > One-click PTZ control** and follow the instructions for the installation packages.
2. Connect the remote PTZ camera:
  - 2.1. Go to **Settings > System > One-click PTZ control** and click **Configure**.
  - 2.2. Go to **One-click PTZ control > PTZ remote connection** and click **Configure**.
  - 2.3. Add the IP address and password for the remote PTZ camera.
  - 2.4. Click **Connect** and verify the connection status.
  - 2.5. Turn on **One-click PTZ control** and click **Close**.
3. Calibrate the PTZ camera automatically:
  - 3.1. Go to **One-click PTZ control > PTZ positioning calibration** and click **Start application**.
  - 3.2. Click **Auto**.  
The auto-calibration will take a few minutes.
  - 3.3. Click **Done**.
  - 3.4. Go to the live view of your panoramic camera and click in the image to verify that the PTZ camera moves to the correct position.

If the automatic calibration doesn't provide accurate positions, you can calibrate the PTZ camera manually.

1. Go to **One-click PTZ control > PTZ positioning calibration** and click **Manual**.

2. Click **Re-calibrate**.
3. Define a point in the live view of your panoramic camera and direct the remote PTZ camera to the same position.
4. Click **Save** and repeat three times.
5. Click **Done**.

### **Metadata visualization**

Analytics metadata is available for moving objects in the scene. Supported object classes are visualized in the video stream through a bounding box surrounding the object, along with information about the object type and confidence level of the classification. To learn more about how to configure and consume analytics metadata, see *AXIS Scene Metadata integration guide*.

## Troubleshooting

### Reset to factory default settings

#### Important

Reset to factory default should be used with caution. A reset to factory default resets all settings, including the IP address, to the factory default values.

To reset the product to the factory default settings:

1. Disconnect power from the product.
2. Press and hold the control button while reconnecting power. See *Product overview, on page 31*.
3. Keep the control button pressed for 15–30 seconds until the status LED indicator flashes amber.
4. Release the control button. The process is complete when the status LED indicator turns green. If no DHCP server is available on the network, the device IP address will default to one of the following:
  - **Devices with AXIS OS 12.0 and later:** Obtained from the link-local address subnet (169.254.0.0/16)
  - **Devices with AXIS OS 11.11 and earlier:** 192.168.0.90/24
5. Use the installation and management software tools to assign an IP address, set the password, and access the device.  
The installation and management software tools are available from the support pages on [axis.com/support](https://axis.com/support).

You can also reset parameters to factory default through the device's web interface. Go to **Maintenance > Factory default** and click **Default**.

### AXIS OS options

Axis offers device software management according to either the active track or the long-term support (LTS) tracks. Being on the active track means continuously getting access to all the latest product features, while the LTS tracks provide a fixed platform with periodic releases focused mainly on bug fixes and security updates.

Using AXIS OS from the active track is recommended if you want to access the newest features, or if you use Axis end-to-end system offerings. The LTS tracks are recommended if you use third-party integrations, which are not continuously validated against the latest active track. With LTS, the products can maintain cybersecurity without introducing any significant functional changes or affecting any existing integrations. For more detailed information about Axis device software strategy, go to [axis.com/support/device-software](https://axis.com/support/device-software).

### Check the current AXIS OS version

AXIS OS determines the functionality of our devices. When you troubleshoot a problem, we recommend that you to start by checking the current AXIS OS version. The latest version might contain a correction that fixes your particular problem.

To check the current AXIS OS version:

1. Go to the device's web interface > **Status**.
2. Under **Device info**, see the AXIS OS version.

### Upgrade AXIS OS

#### Important

- When you upgrade the device software, your preconfigured and customized settings are saved. Axis Communications AB can't guarantee that the settings are saved, even if the features are available in the new AXIS OS version.
- Starting from AXIS OS 12.6, you must install every LTS version between your device's current version and the target version. For example, if the currently installed device software version is AXIS OS 11.2, you

have to install the LTS version AXIS OS 11.11 before you can upgrade the device to AXIS OS 12.6. For more information, see *AXIS OS Lifecycle guide: Upgrade path*.

- Make sure the device remains connected to the power source throughout the upgrade process.

### Note

- When you upgrade the device with the latest AXIS OS version in the active track, the product receives the latest functionality available. Always read the upgrade instructions and release notes available with each new release before you upgrade. To find the latest AXIS OS version and the release notes, go to [axis.com/support/device-software](https://axis.com/support/device-software).
1. Download the AXIS OS file to your computer, available free of charge at [axis.com/support/device-software](https://axis.com/support/device-software).
  2. Log in to the device as an administrator.
  3. Go to **Maintenance > AXIS OS upgrade** and click **Upgrade**.

When the upgrade has finished, the product restarts automatically.

You can use AXIS Device Manager to upgrade multiple devices at the same time. Find out more at [axis.com/products/axis-device-manager](https://axis.com/products/axis-device-manager).

## Technical problems and possible solutions

### Problems upgrading AXIS OS

#### AXIS OS upgrade failed

If the upgrade fails, the device reloads the previous version. The most common reason is that the wrong AXIS OS file has been uploaded. Check that the name of the AXIS OS file corresponds to your device and try again.

#### Problems after AXIS OS upgrade

If you experience problems after the upgrade, roll back to the previously installed version from the **Maintenance** page.

### Problems setting the IP address

#### Can't set the IP address

- If the IP address intended for the device and the IP address of the computer used to access the device are located on different subnets, you can't set the IP address. Contact your network administrator to obtain an IP address.
- The IP address could be in use by another device. To check:
  1. Disconnect the Axis device from the network.
  2. In a Command/DOS window, type `ping` and the IP address of the device.
  3. If you receive: `Reply from <IP address>: bytes=32; time=10...` this means that the IP address might already be in use by another device on the network. Obtain a new IP address from the network administrator and reinstall the device.
  4. If you receive: `Request timed out`, this means that the IP address is available for use with the Axis device. Check all cabling and reinstall the device.
- There could be a possible IP address conflict with another device on the same subnet. The static IP address in the Axis device is used before the DHCP server sets a dynamic address. This means that if the same default static IP address is also used by another device, there could be problems accessing the device.

### Problems accessing the device

**Can't log in when accessing the device from a browser**

When HTTPS is enabled, make sure that you use the correct protocol (HTTP or HTTPS) when you try to log in. You might need to manually type `http` or `https` in the browser's address field.

If you've lost the password for the root account, you must reset the device to the factory default settings. For instructions, see *Reset to factory default settings, on page 25*.

**The IP address has been changed by DHCP**

IP addresses obtained from a DHCP server are dynamic and could change. If the IP address has been changed, use AXIS IP Utility or AXIS Device Manager to locate the device on the network. Identify the device using its model or serial number, or by the DNS name (if the name has been configured).

If required, you can assign a static IP address manually. For instructions, go to [axis.com/support](http://axis.com/support).

**Certificate error when using IEEE 802.1X**

For authentication to work properly, the date and time settings in the Axis device must be synchronized with an NTP server. Go to **System > Date and time**.

**The browser isn't supported**

For a list of recommended browsers, see *Browser support, on page 5*.

**Can't access the device externally**

To access the device externally, we recommend you to use one of the following applications for Windows®:

- AXIS Camera Station Edge: free of charge, ideal for small systems with basic surveillance needs.
- AXIS Camera Station Pro: 90-day trial version free of charge, ideal for small to mid-size systems.

For instructions and download, go to [axis.com/vms](http://axis.com/vms).

**Problems with streaming**

**Multicast H.264 only accessible by local clients**

Check if your router supports multicasting, or if you need to configure the router settings between the client and the device. You might need to increase the TTL (Time To Live) value.

**No multicast H.264 displayed in the client**

Check with your network administrator that the multicast addresses used by the Axis device are valid for your network.

Check with your network administrator to see if there is a firewall that prevents viewing.

**Poor rendering of H.264 images**

Ensure that your graphics card uses the latest driver. You can usually download the latest drivers from the manufacturer's website.

**Color saturation is different in H.264 and Motion JPEG**

Modify the settings for your graphics adapter. Check the adapter's documentation for more information.

#### Lower frame rate than expected

- See *Performance considerations, on page 28*.
- Reduce the number of applications running on the client computer.
- Limit the number of simultaneous viewers.
- Check with the network administrator that there is enough bandwidth available.
- Lower the image resolution.
- Log in to the device's web interface and set a capture mode that prioritizes frame rate. If you change the capture mode to prioritize frame rate it might lower the maximum resolution, depending on the device used and capture modes available.
- The maximum frames per second is dependent on the utility frequency (60/50 Hz) of the Axis device.

#### Can't select H.265 encoding in live view

Web browsers don't support H.265 decoding. Use a video management system or application that supports H.265 decoding.

### Problems with MQTT

#### Can't connect over port 8883 with MQTT over SSL

The firewall blocks traffic that uses port 8883 since it's regarded insecure.

In some cases the server/broker might not provide a specific port for MQTT communication. It might still be possible to use MQTT over a port normally used for HTTP/HTTPS traffic.

- If the server/broker supports WebSocket/WebSocket Secure (WS/WSS), typically on port 443, use this protocol instead. Check with the server/broker provider to see if WS/WSS is supported and which port and basepath to use.
- If the server/broker supports ALPN, the use of MQTT can be negotiated over an open port, such as 443. Check with your server/broker provider to see if ALPN is supported and which ALPN protocol and port to use.

If you can't find what you're looking for here, try the troubleshooting section at [axis.com/support](https://axis.com/support).

### Performance considerations

When you set up your system, it's important to consider how different settings and situations affect performance. Some factors affect bandwidth (bitrate), others affect frame rate, and some affect both.

The most important factors to consider:

- High image resolution or lower compression levels result in images containing more data which in turn affects the bandwidth.
- Rotating the image in the GUI can increase the product's CPU load.
- Access by large numbers of Motion JPEG clients or unicast H.264/H.265/AV1 clients affects the bandwidth.
- Simultaneous viewing of different streams (resolution, compression) by different clients affects both frame rate and bandwidth.  
Use identical streams wherever possible to maintain a high frame rate. Stream profiles can be used to ensure that streams are identical.
- Accessing video streams with different codecs simultaneously affects both frame rate and bandwidth. For optimal performance, use streams with the same codec.

- Heavy usage of event settings affects the product's CPU load which in turn affects the frame rate.
- Using HTTPS may reduce frame rate, in particular if streaming Motion JPEG.
- Heavy network utilization due to poor infrastructure affects the bandwidth.
- Viewing on poorly performing client computers lowers perceived performance and affects frame rate.
- Running multiple AXIS Camera Application Platform (ACAP) applications simultaneously may affect the frame rate and the general performance.

### **Contact support**

If you need more help, go to [axis.com/support](https://axis.com/support).

## Clean your device

You can clean your device with lukewarm water and mild, nonabrasive soap.

### **NOTICE**

- Harsh chemicals can damage the device. Don't use chemicals such as window cleaner or acetone to clean your device.
  - Avoid cleaning in direct sunlight or elevated temperatures, since this can cause stains.
1. Use a can of compressed air to remove dust and loose dirt from the device.
  2. If necessary, clean the device with a soft microfiber cloth dampened with lukewarm water and mild, nonabrasive soap.
  3. To remove any residual cleaning agents, wipe the device with a soft microfiber cloth dampened with lukewarm water.
  4. To avoid stains, dry the device with a clean, nonabrasive cloth.

For more information about cleaning of Axis devices, see the white paper *Chemical resistance to common cleaning agents*.

## Specifications

### Product overview

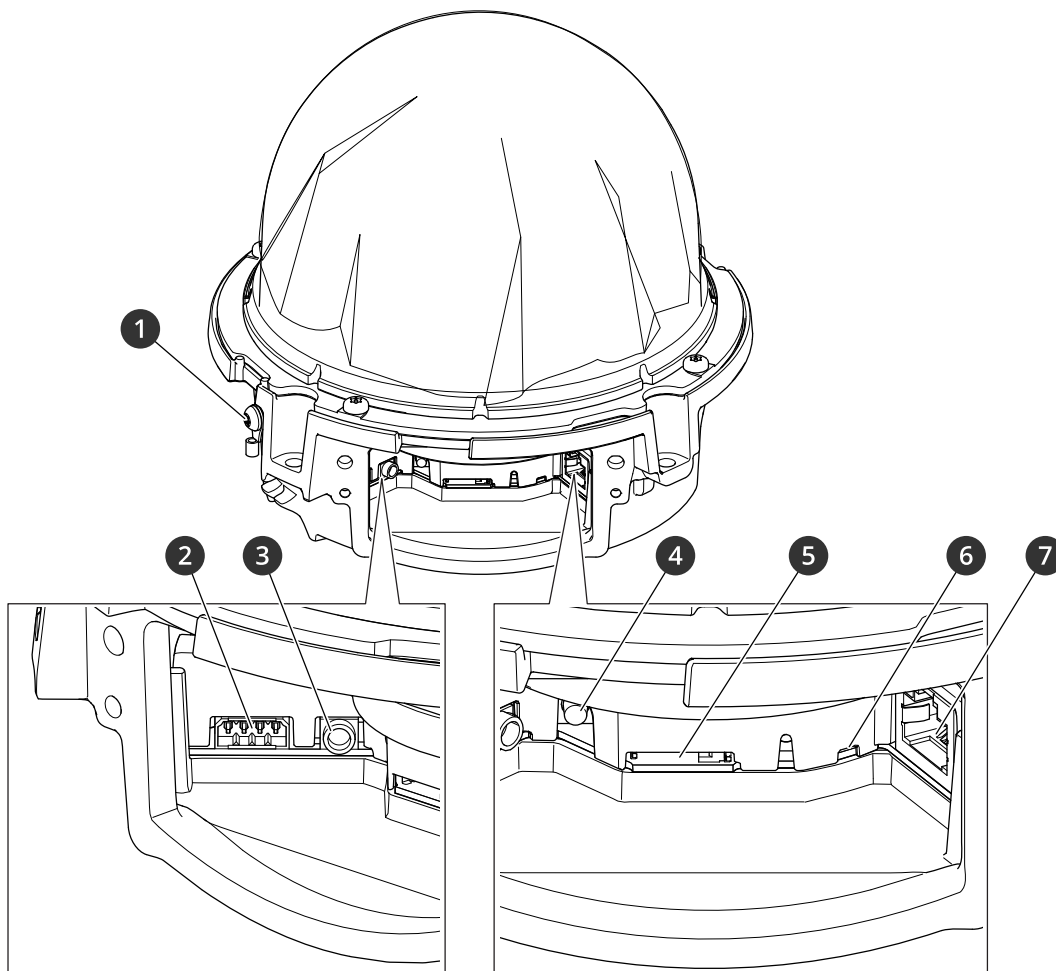

- 1 Grounding cable
- 2 I/O port
- 3 Audio input
- 4 Control button
- 5 Micro SD card slot
- 6 LED status indicator
- 7 PoE connector

### LED indicators

| Status LED | Indication   |
|------------|--|
| Unlit      | Connection and normal operation.   |
| Green      | Shows steady green for 10 seconds for normal operation after startup completed.            |
| Amber      | Steady during startup. Flashes during device software upgrade or reset to factory default. |
| Amber/Red  | Flashes amber/red if network connection is unavailable or lost.                            |

## SD card slot

### NOTICE

- Risk of damage to SD card. Don't use sharp tools, metal objects, or excessive force when inserting or removing the SD card. Use your fingers to insert and remove the card.
- Risk of data loss and corrupted recordings. Unmount the SD card from the device's web interface before removing it. Don't remove the SD card while the product is running.

This device supports microSD/microSDHC/microSDXC cards.

For SD card recommendations, see *axis.com*.



microSD, microSDHC, and microSDXC Logos are trademarks of SD-3C LLC. microSD, microSDHC, microSDXC are trademarks or registered trademarks of SD-3C, LLC in the United States, other countries or both.

## Buttons

### Control button

The control button is used for:

- Resetting the product to factory default settings. See *Reset to factory default settings, on page 25*.

## Connectors

### Network connector

RJ45 Ethernet connector with Power over Ethernet (PoE).

### I/O connector

Use the I/O connector with external devices in combination with, for example, motion detection, event triggering, and alarm notifications. In addition to the 0 VDC reference point and power (12 V DC output), the I/O connector provides the interface to:

**Digital input** – For connecting devices that can toggle between an open and closed circuit, for example PIR sensors, door/window contacts, and glass break detectors.

**Supervised input** – Enables possibility to detect tampering on a digital input.

**Digital output** – For connecting external devices such as relays and LEDs. Connected devices can be activated by the VAPIX® Application Programming Interface, through an event or from the device's web interface.

4-pin terminal block

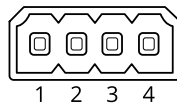

### I/O connector tables

| Function  | Pin | Notes  | Specifications              |
|-----------|-----|--|-----------------------------|
| DC ground | 1   |  | 0 V DC                      |
| DC output | 2   | Can be used to power auxiliary equipment.<br>Note: This pin can only be used as power out. | 12 V DC<br>Max load = 50 mA |

|                                |     |   |                                      |
|--------------------------------|-----|---|--------------------------------------|
| Configurable (Input or Output) | 3-4 | Digital input or Supervised input – Connect to pin 1 to activate, or leave floating (unconnected) to deactivate. To use supervised input, install end-of-line resistors. See connection diagram for information about how to connect the resistors. | 0 to max 28 V DC                     |
|                                |     | Digital output – Internally connected to pin 1 (DC ground) when active, and floating (unconnected) when inactive. If used with an inductive load, e.g., a relay, connect a diode in parallel with the load, to protect against voltage transients.  | 0 to max 28 V DC, open drain, 100 mA |

Example:

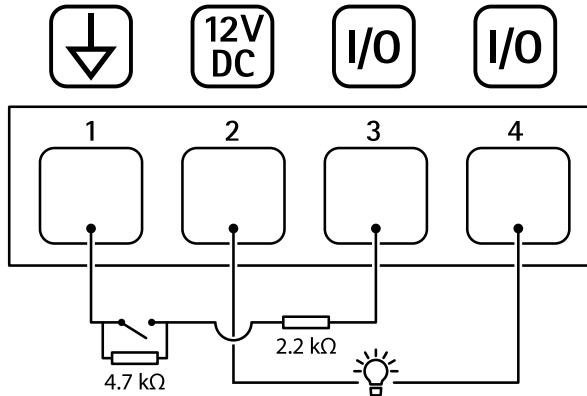

- 1 DC ground
- 2 DC output 12 V, max 50 mA
- 3 I/O configured as supervised input
- 4 I/O configured as output

## Cybersecurity

Cybersecurity supports a successful product lifecycle with minimized risks. You can find in-depth information and documentation about our cybersecurity approach at [axis.com/about-axis/cybersecurity](https://axis.com/about-axis/cybersecurity). Follow the cybersecurity guidelines below to receive product security notifications from Axis and to configure your product for a secure lifecycle and decommissioning.

At *Axis Trust Center*, you can find information about how Axis implements security compliance, transparency, data protection, and privacy.

### Vulnerability management

Axis is a *Common Vulnerability and Exposures (CVE) Numbering Authority (CNA)*. To minimize your risk of exposure, we follow industry standards when identifying and resolving vulnerabilities in our devices, software, and services. Refer to [axis.com/vulnerability-management](https://axis.com/vulnerability-management) for information about our vulnerability management policy or to report a vulnerability.

### Security notifications

Subscribe to Axis security notification emails at [axis.com/security-notification-service](https://axis.com/security-notification-service). We will send you information about vulnerabilities, corresponding security advisories, and other security-related matters for your Axis product.

### Secure product lifecycle

Axis minimizes risks throughout the lifetime of our products through secure lifecycle management. Use our hardening guides at [help.axis.com](https://help.axis.com) to more securely configure and operate your Axis products and to find information about:

**Secure first-use** – Axis products are pre-configured with high default protection to allow for secure initialization and encrypted communication from the very start.

**Intended use and common configuration mistakes** – Our guides provide information about the intended usage of Axis products, including common security-relevant misuse and configuration mistakes that should be avoided.

**Managing vulnerabilities and supply chain transparency** – A Software Bill of Material (SBOM) is published with every software release on [axis.com](https://axis.com) to disclose vulnerabilities and improve supply chain transparency.

**Decommissioning and the secure erasure of data** – To securely decommission a product when it reaches the end of its lifecycle, reset it to factory default settings. This erases your configurations, stored data, and sensitive information.



T10158553

2026-07 (M28.2)

© 2020 – 2026 Axis Communications AB